

# 2010现代劳恩斯向前&向后驻车辅助系统电路图

## 摘要:

该文档主要描述2010现代劳恩斯向前&向后驻车辅助系统电路图。





## 关键字:

2010 现代 劳恩斯 电子驻车制动系统 电路图 向前&向后驻车辅助系统 驻车 制动

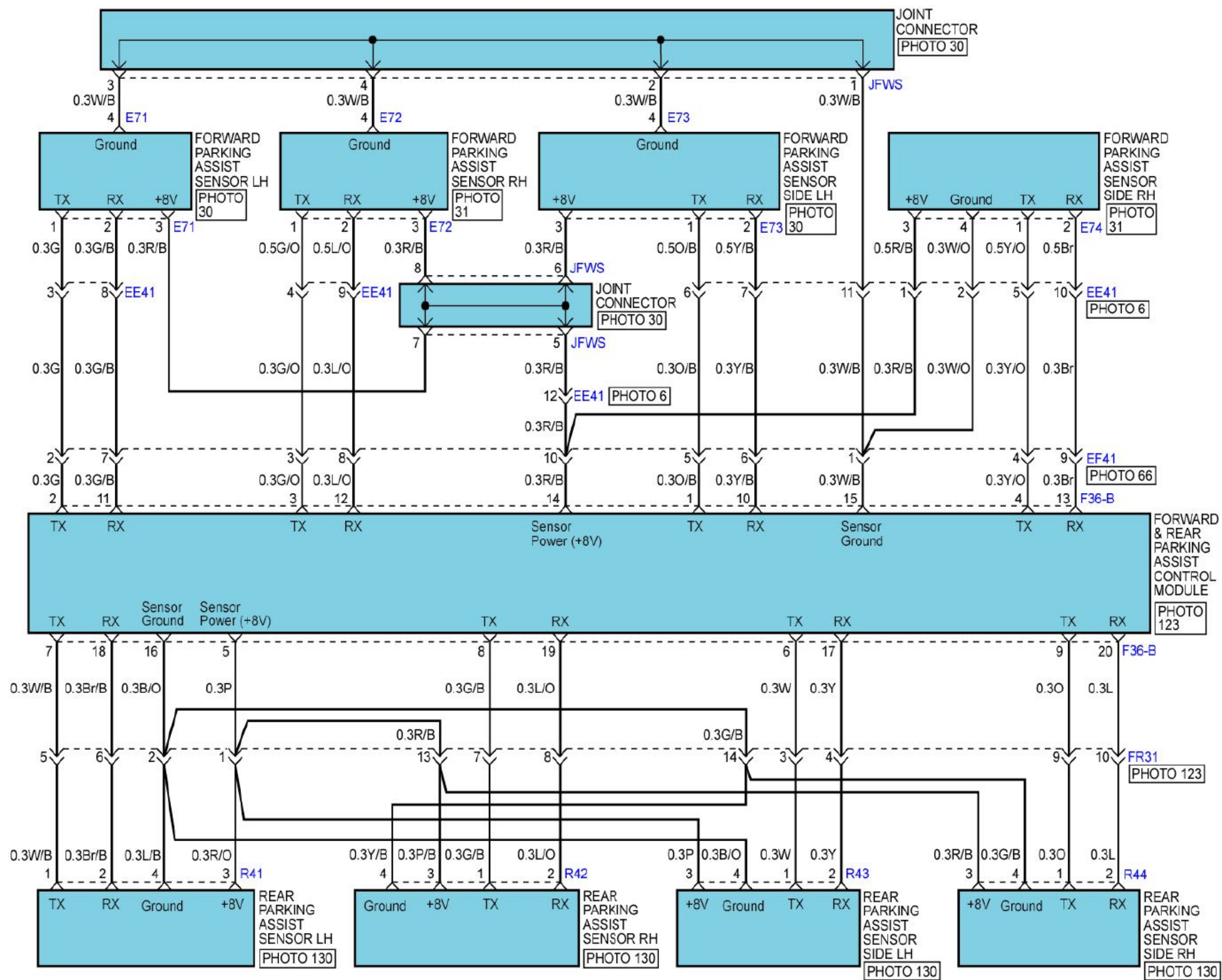
LAUNCH



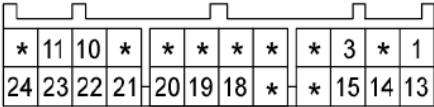
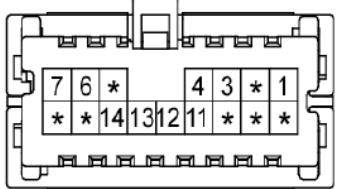
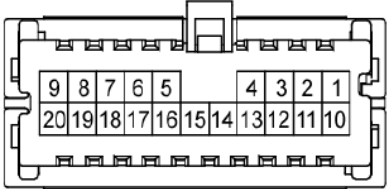
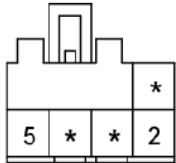
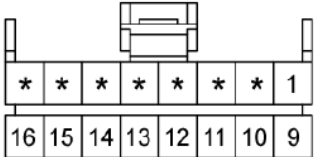

<p>E71/E72</p> 	<p>E73/E74</p> 	<p>F10</p> 	<p>F36-A</p> 
<p>F36-B</p> 	<p>M53</p> 	<p>M62</p> 	<p>R41/R42</p> 
<p>R43/R44</p> 