

2010帕杰罗点火系统电路图

摘要:

该文档主要描述 2010 三菱帕杰罗巡航控制系统电路图。

关键字:

2010 三菱 帕杰罗 电路图 插接器 电源 巡航控制系统

LAUNCH

目录

1. 巡航控制系统 (4M41)	1
2. 巡航控制系统 (6G7)	5

LAUNCH

1. 巡航控制系统 (4M41)

1

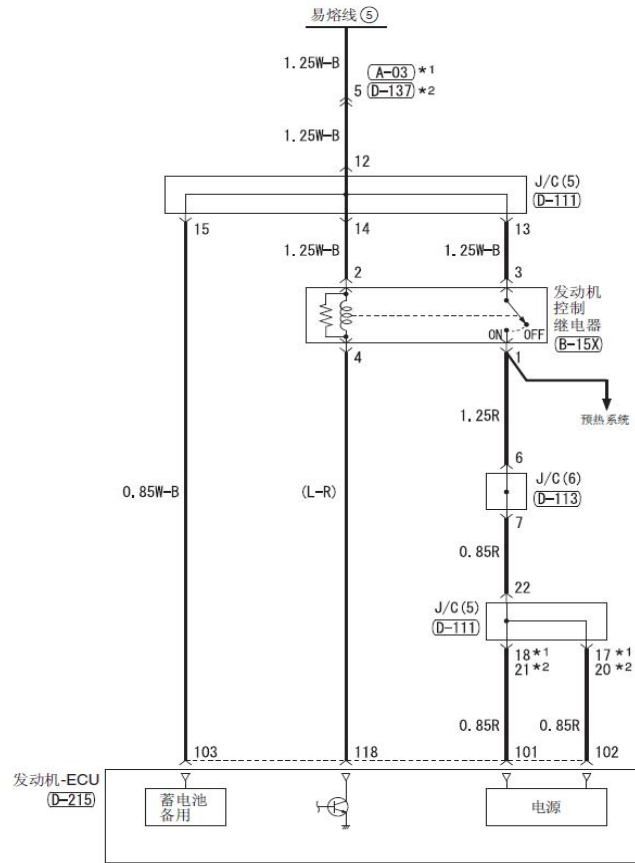

2

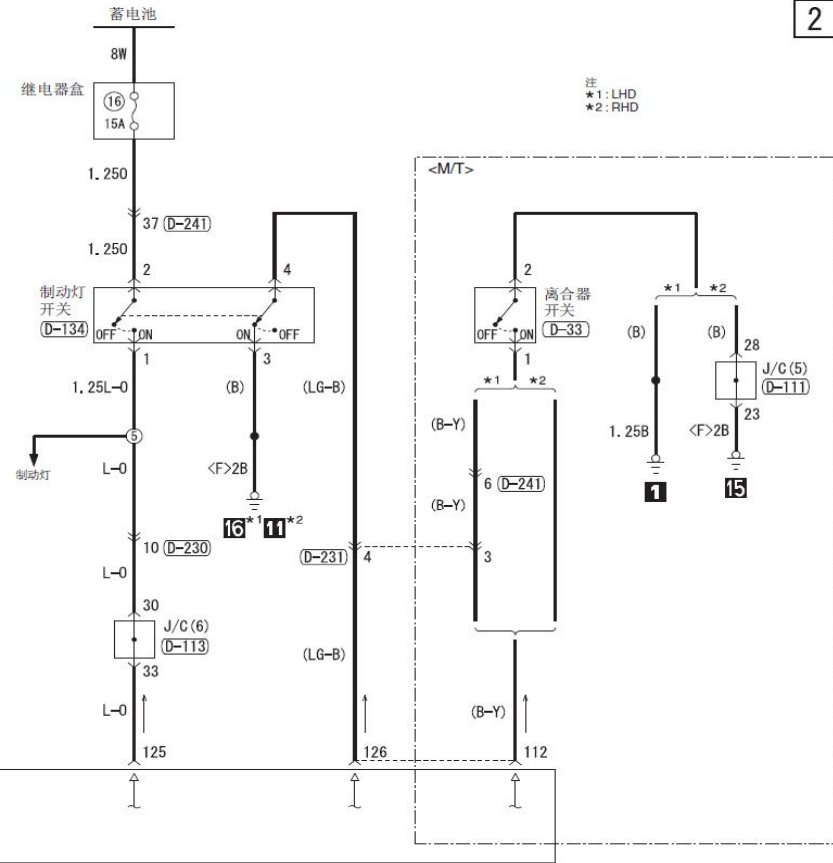

A-03 MU802645	B-15X 1 2 3 4	D-33 1 2	D-111 1 2 3 4 5 6 7 8 9 10 11 12 13 14 15 16 17 18 19 20 21 22 23 24 25 26 27 28 29 30 31 32 33	D-113 1 2 3 4 5 6 7 8 9 10 11 12 13 14 15 16 17 18 19 20 21 22 23 24 25 26 27 28 29 30 31 32 33	D-134 MU801491	D-137 MU801855	D-215	D-230	D-231 MU801515
-------------------------	-------------------------	--------------------	---	---	--------------------------	--------------------------	--------------	--------------	--------------------------

线色代码

B: 黑色 LG: 浅绿色 G: 绿色 L: 蓝色 W: 白色

Y: 黄色 SB: 天蓝色 BR: 棕色 O: 橙色 GR: 灰色

R: 红色 P: 粉红色 V: 紫罗兰色 PU: 紫色 SI: 银色

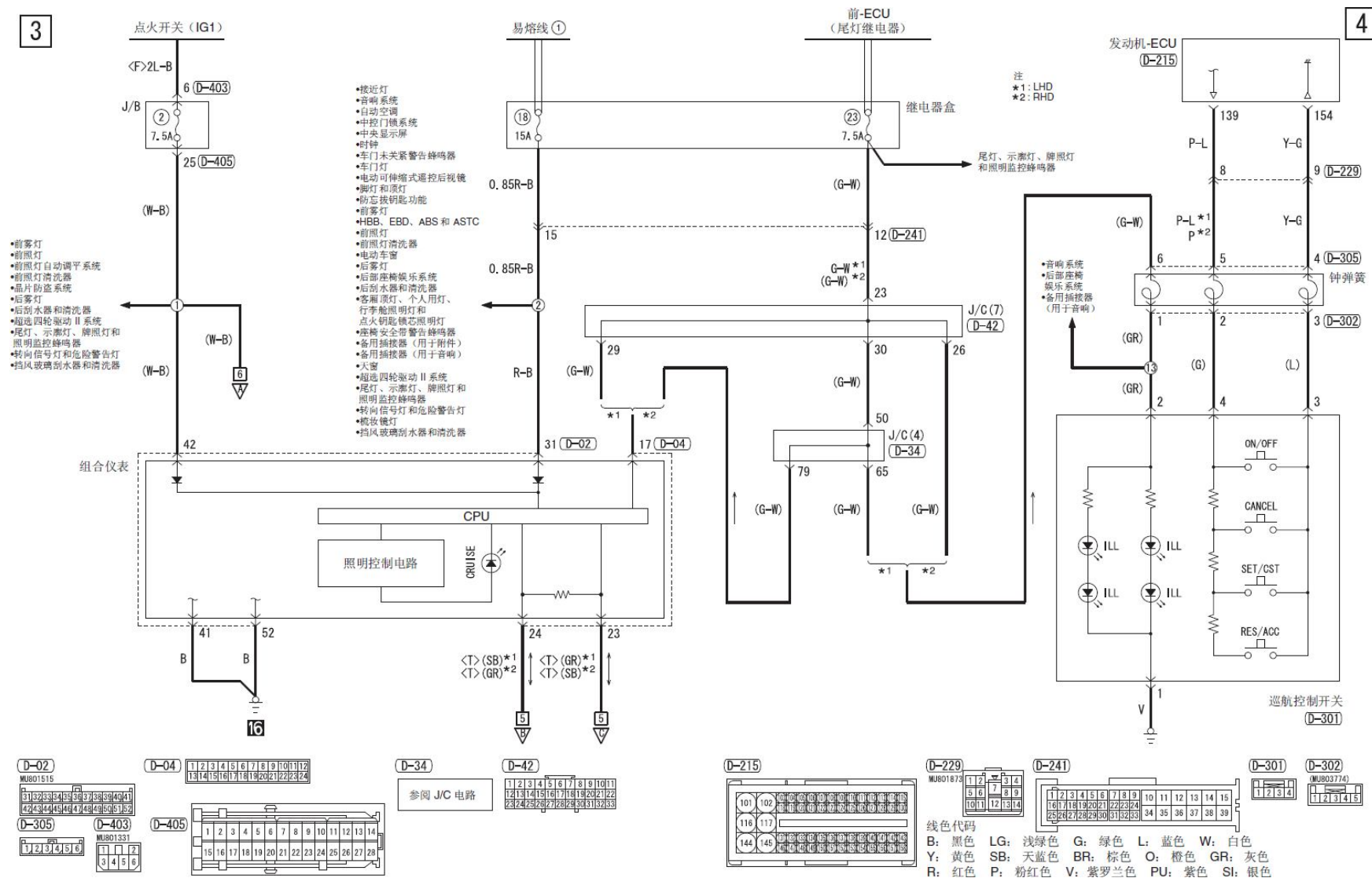

5

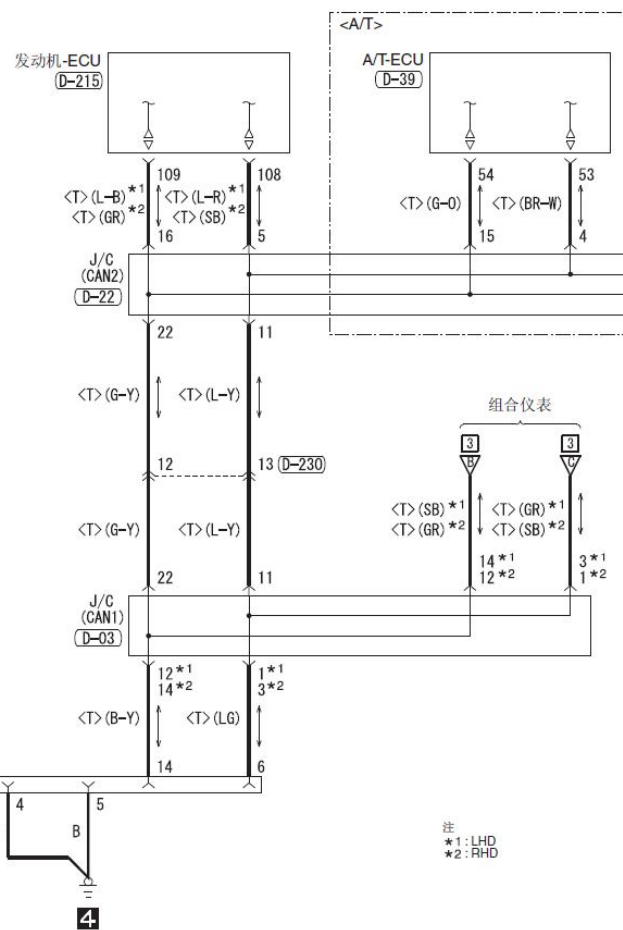
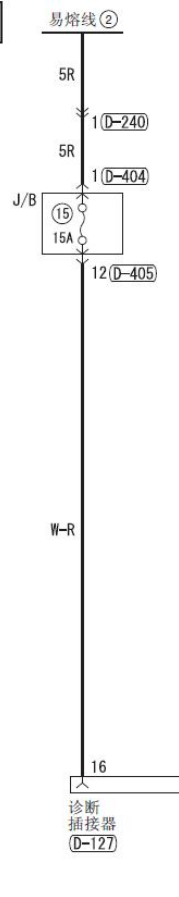

注
*1: LHD
*2: RHD

4

6

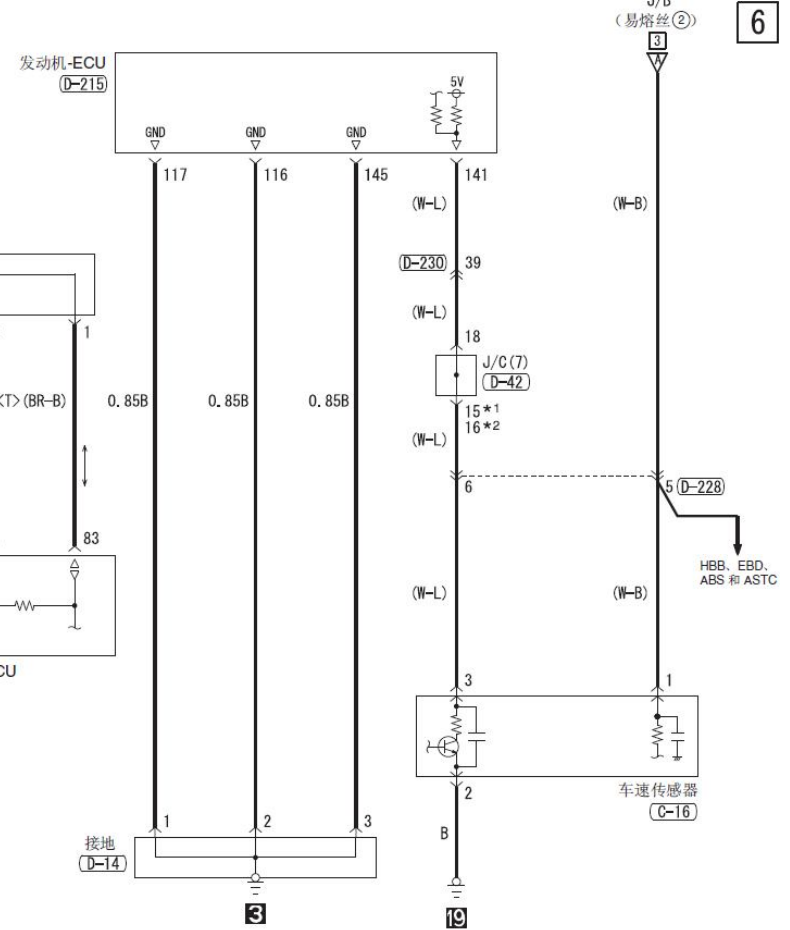

3

10

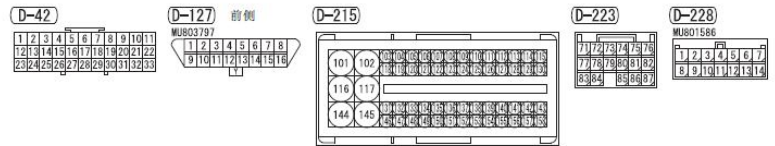
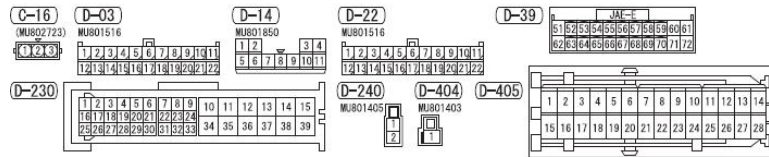

7

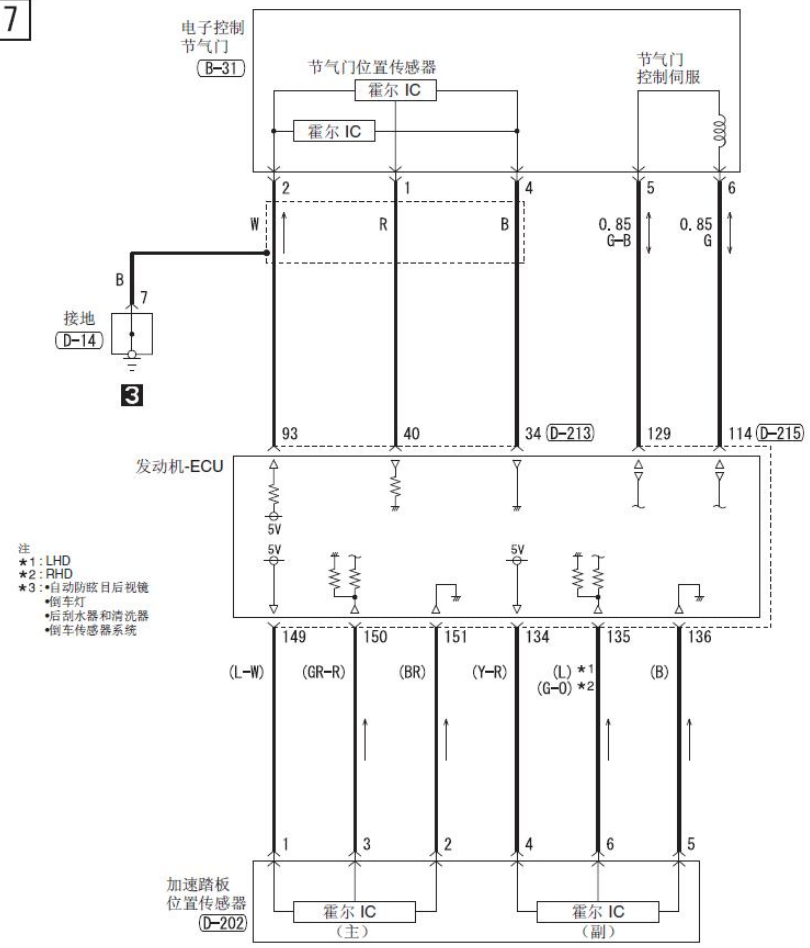

注
 *1: LHD
 *2: RHD
 *3: 自动防眩目后视镜
 • 倒车灯
 • 后刮水器和清洗器
 • 倒车传感器系统

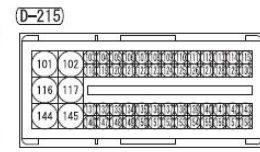
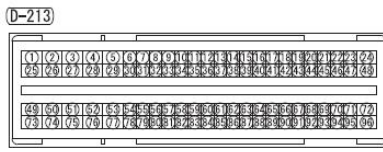
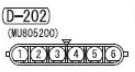
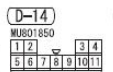
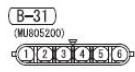

8

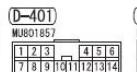
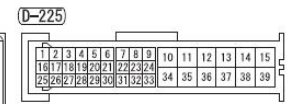
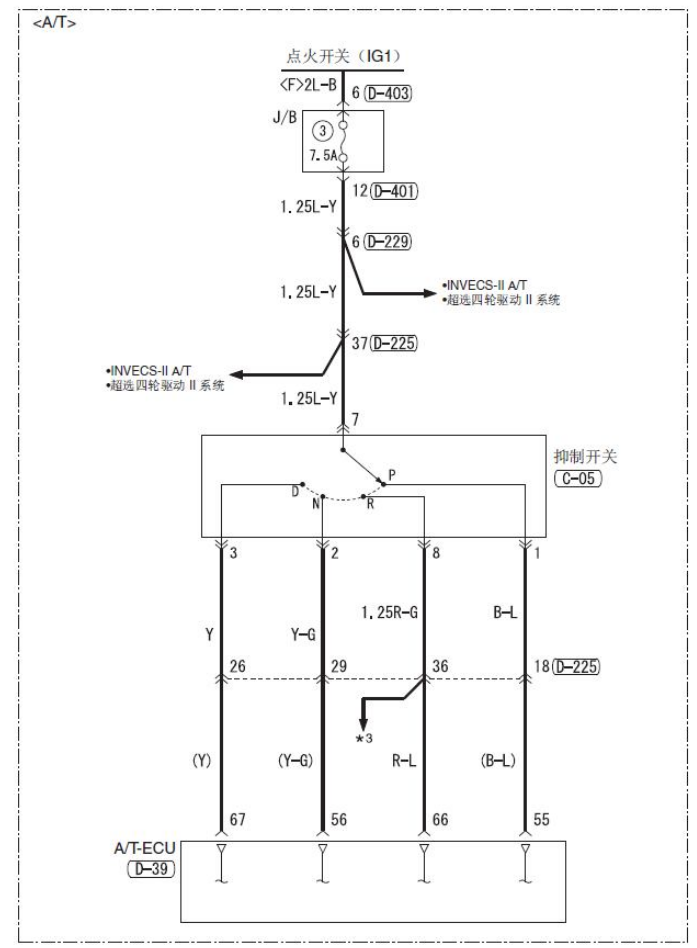

2. 巡航控制系统 (6G7)

LAUNCH

1

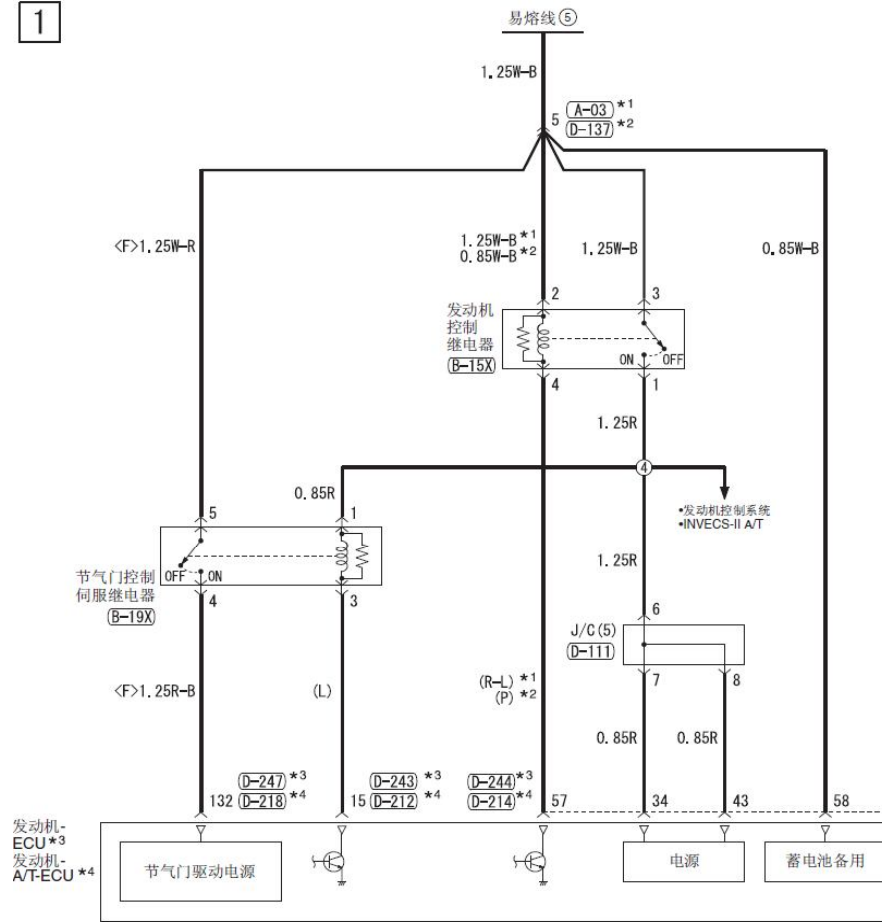

2

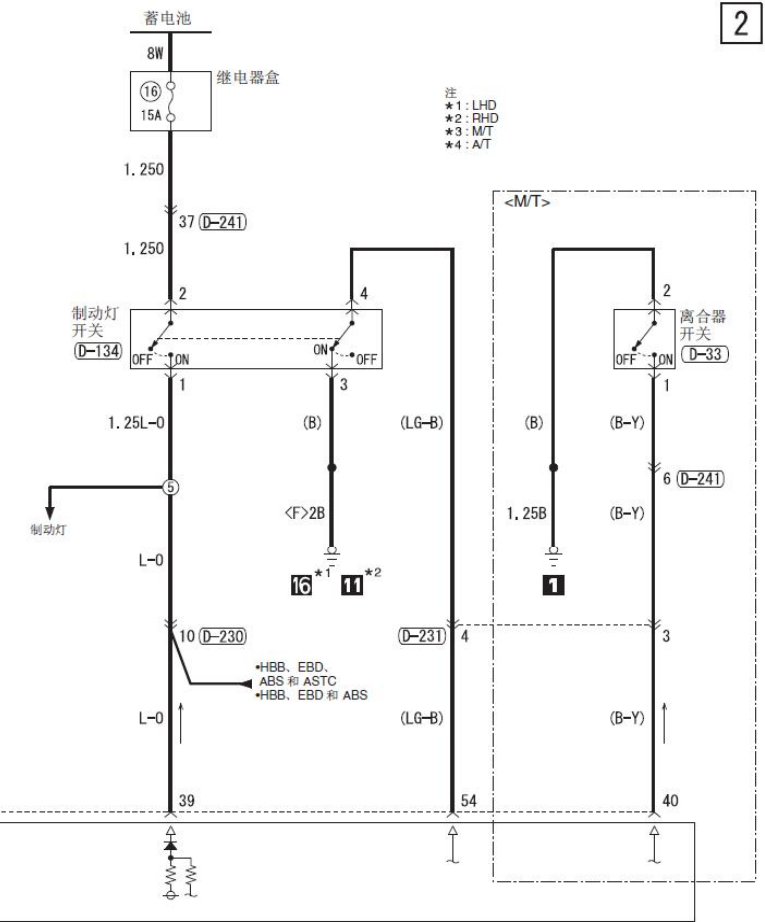

注
*1: LHD
*2: RHD
*3: MT
*4: AT

(A-03) MUR02645 1 2 3 4	(B-15X) 1 2 3 4	(B-19X) 1 2 3 4	(D-33) 1 2	(D-111) 1 2 3 4 5 6 7 8 9 10 11 12 13 14 15 16 17 18 19 20 21 22 23 24 25 26 27 28 29 30 31 32 33	(D-134) MUR01491 1 2 3 4	(D-137) MUR01855 1 2 3 4 5 6 7 8 9 10 11 12 13	(D-212) MUR03802 1 2 JAE 3 4 5 6 7 8 9 10 11 12 13 14 15 16 17 18 19 20 21 22 23 24 25 26 27	(D-214) MUR03803 31 32 JAE 33 34 35 36 37 38 39 40 41 42 43 44 45 46 47 48 49 50 51 52 53 54 55 56 57 58	(D-218) MUR03801 121 122 JAE 123 124 125 126 127 128 129 130 131 132 133 134 135 136 137 138 139 140 141 142 143 144 145 146	(D-230) 1 2 3 4 5 6 7 8 9 10 11 12 13 14 15 16 17 18 19 20 21 22 23 24 25 26 27 28 29 30 31 32 33 34 35 36 37 38 39	(D-231) MUR01515 1 2 3 4 5 6 7 8 9 10 11 12 13 14 15 16 17 18 19 20 21 22
---	------------------------------	------------------------------	----------------------	---	--	--	--	--	--	---	---

线色代码
B: 黑色 LG: 浅绿色 G: 绿色 L: 蓝色 W: 白色
Y: 黄色 SB: 天蓝色 BR: 棕色 O: 橙色 GR: 灰色
R: 红色 P: 粉红色 V: 紫罗兰色 PU: 紫色 SI: 银色

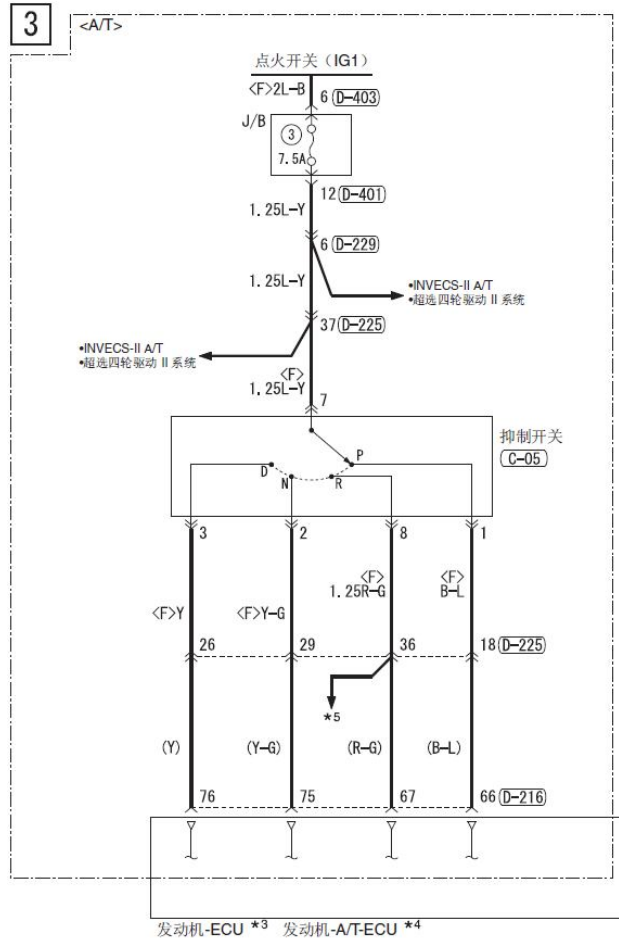

- 注
- *1 : LHD
 - *2 : RHD
 - *3 : M/T
 - *4 : A/T
 - *5 : 自动防眩后视镜
倒车灯
后刮水器和清洗器
倒车传感器系统

