

2010现代劳恩斯音响系统电路图

摘要:

该文档主要描述2010现代劳恩斯音响系统电路图。

关键字:

2010 现代 劳恩斯 电路图 音响系统

LAUNCH

1. 音响系统

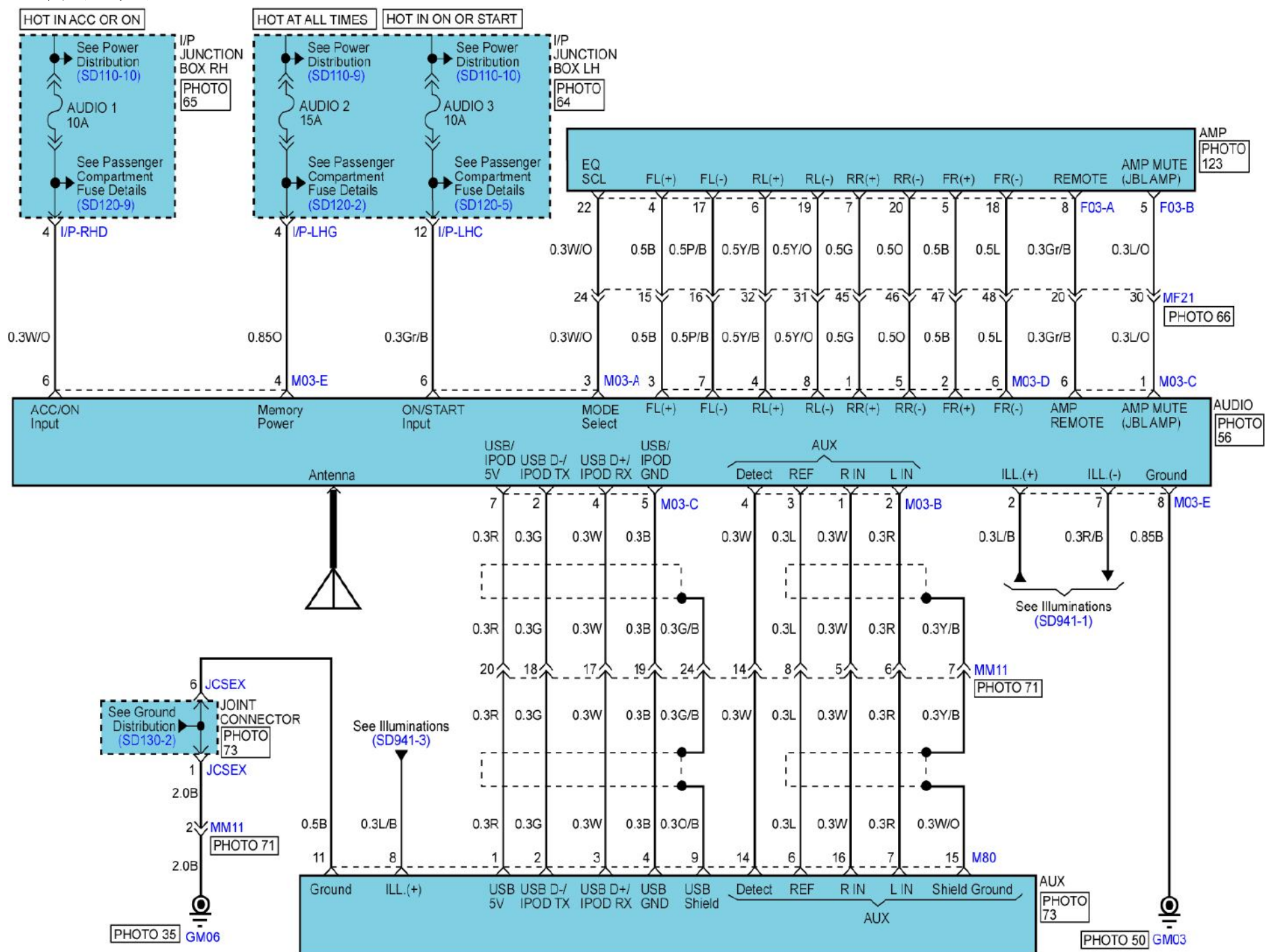

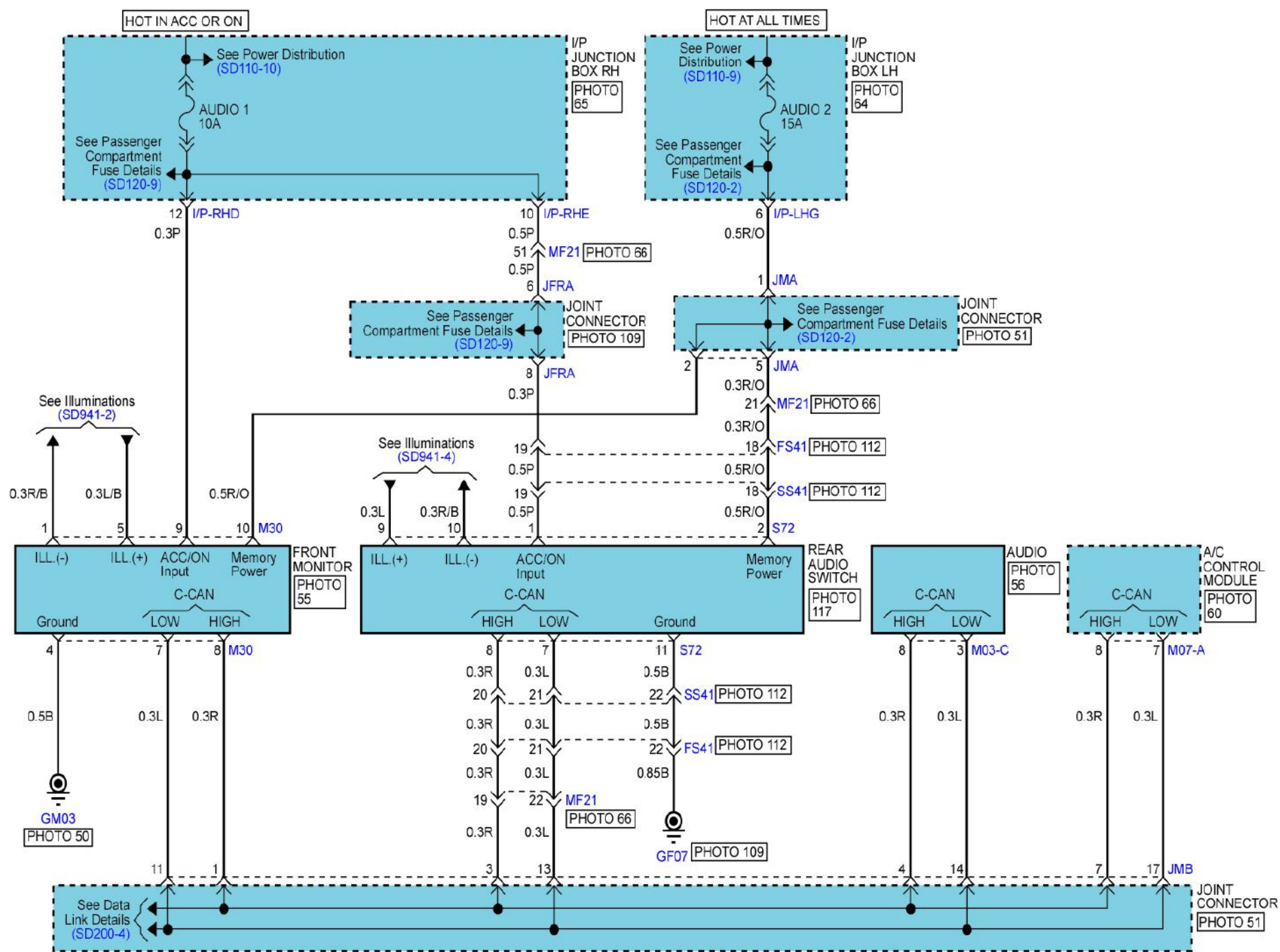

AUDIO AMP

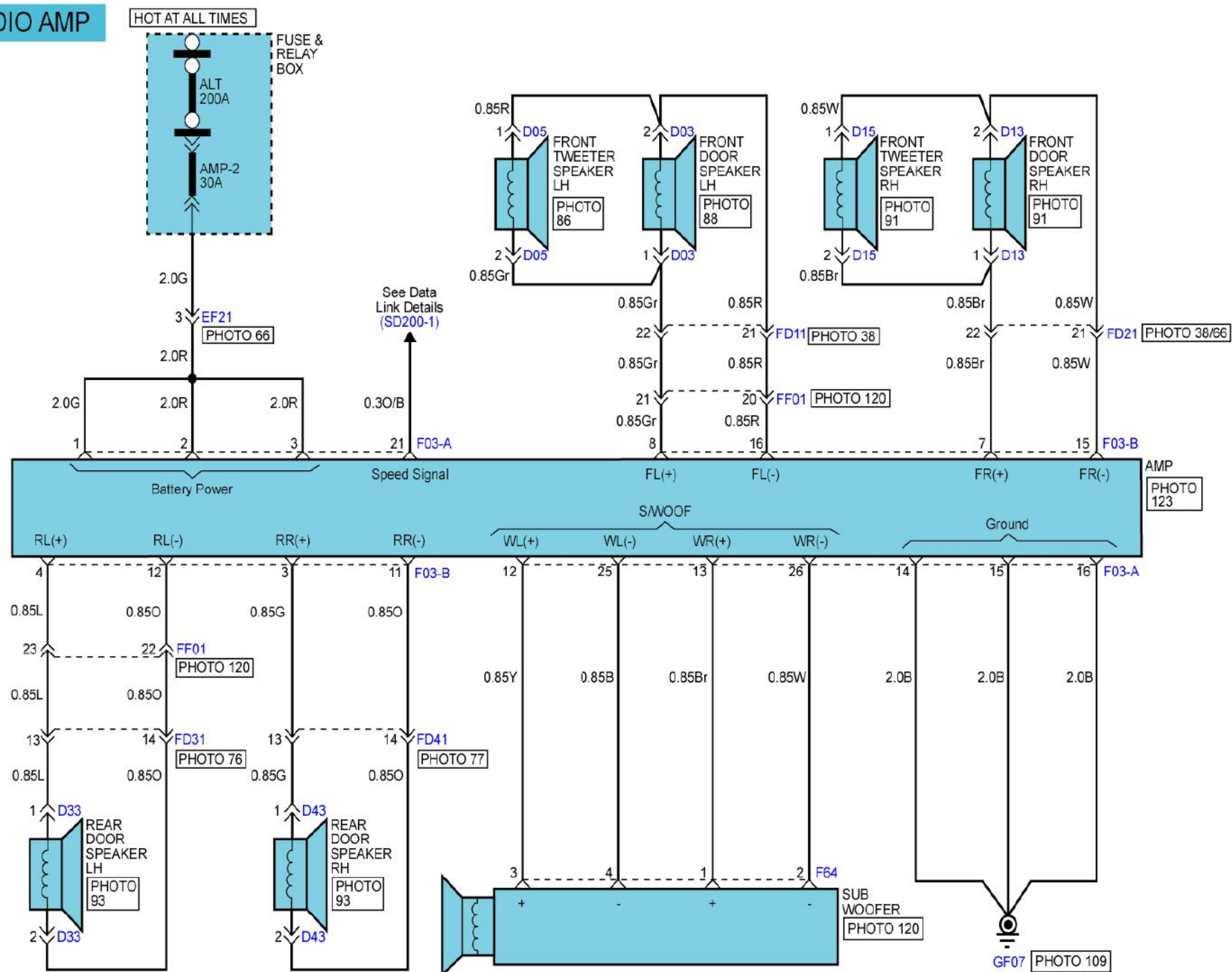

JBL AMP

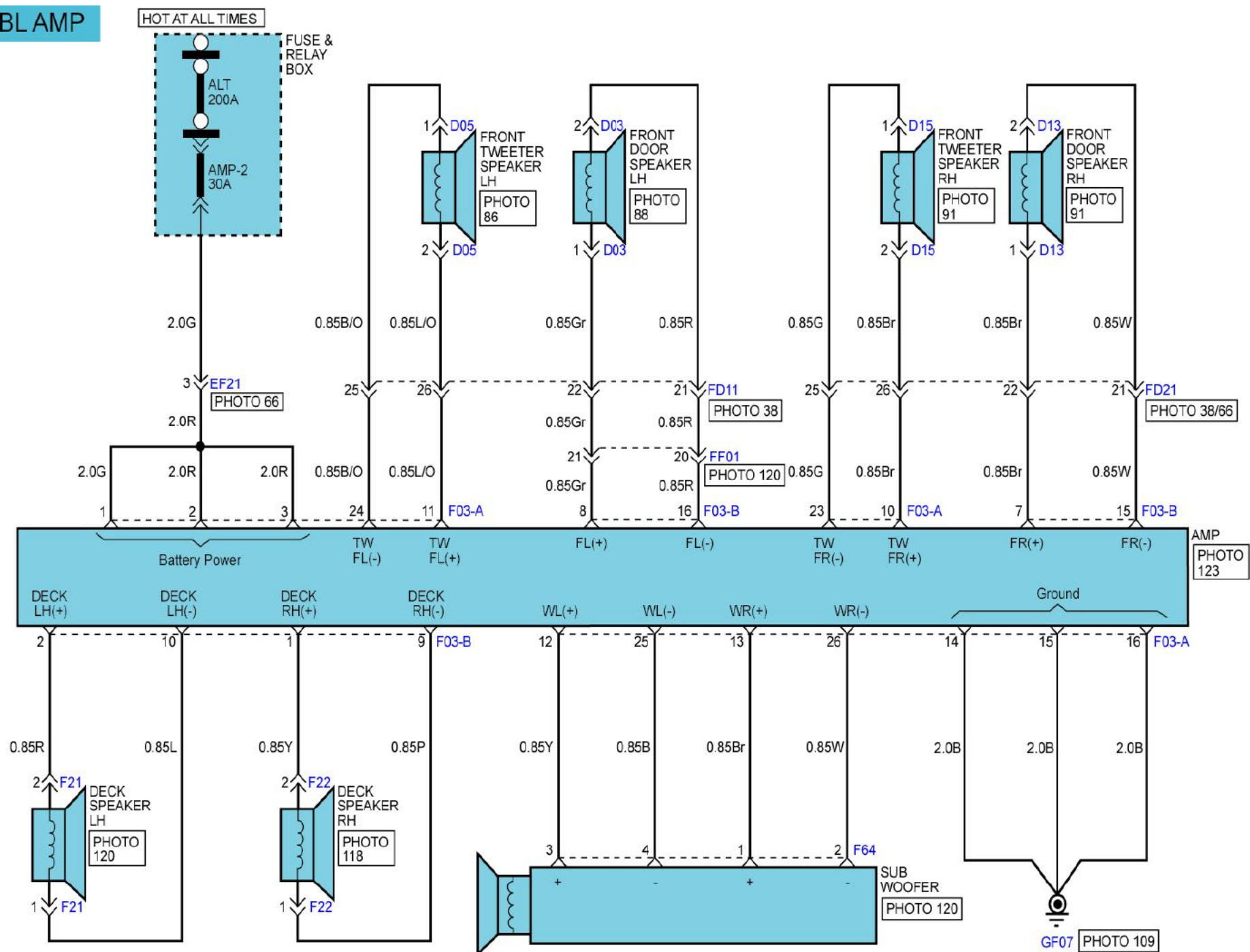

JBL AMP

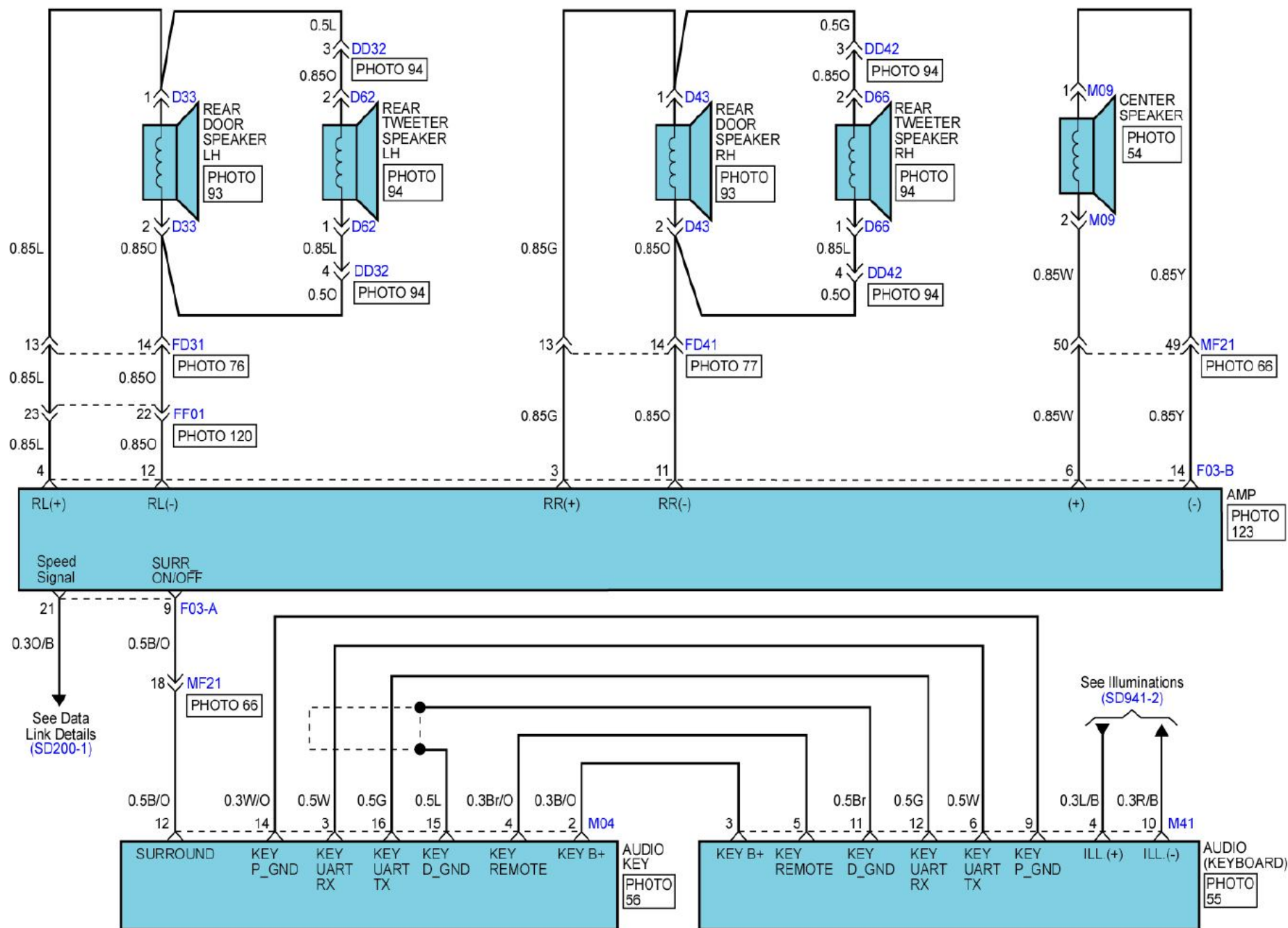

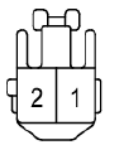
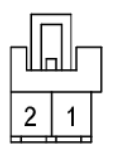
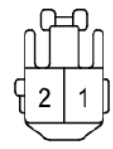
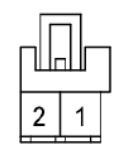
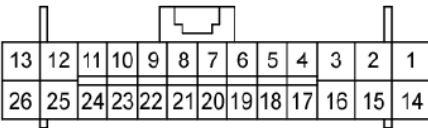
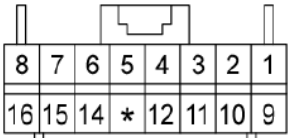
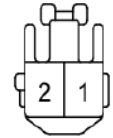
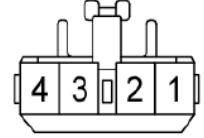
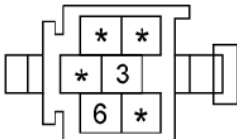
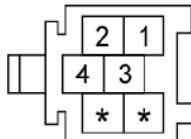
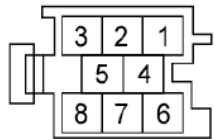
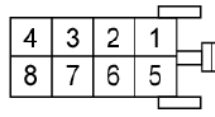
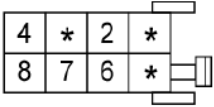
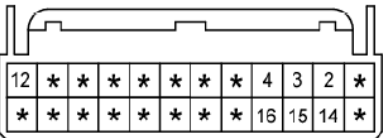
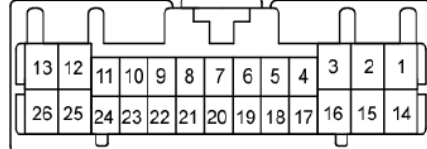
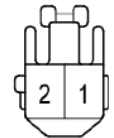
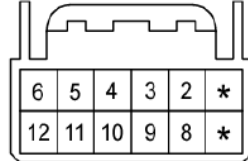
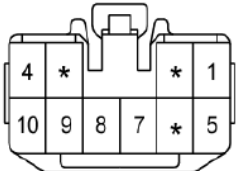
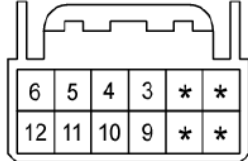
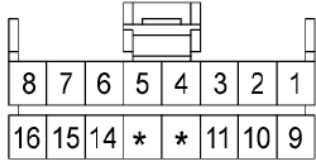
<p>D03/D13</p> 	<p>D05/D15</p> 	<p>D33/D43</p> 	<p>D62/D66</p> 
<p>F03-A</p> 	<p>F03-B</p> 	<p>F21/F22</p> 	<p>F64</p> 
<p>M03-A</p> 	<p>M03-B</p> 	<p>M03-C</p> 	<p>M03-D</p> 
<p>M03-E</p> 	<p>M04</p> 	<p>M07-A</p> 	<p>M09</p> 
<p>M13</p> 	<p>M30</p> 	<p>M41</p> 	<p>M48</p> 

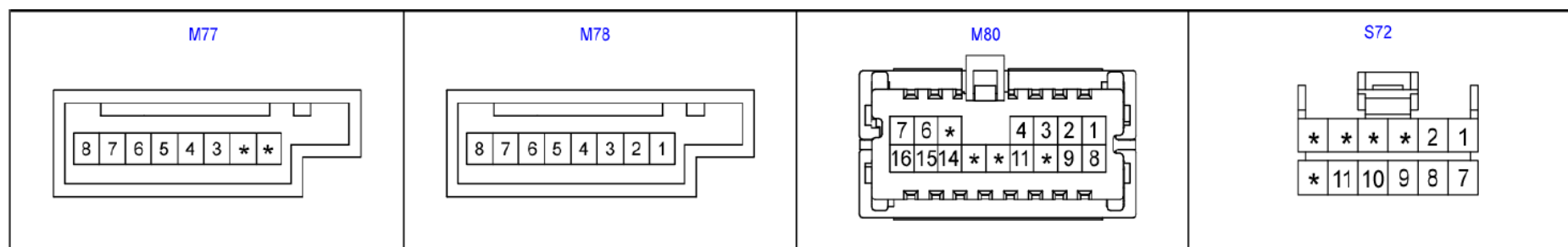

LAUNCH