

2010现代劳恩斯礼貌灯和行李箱灯电路图

摘要:



该文档主要描述2010现代劳恩斯礼貌灯和行李箱灯电路图。

关键字:

2010 现代 劳恩斯 电路图 礼貌灯 行李箱灯

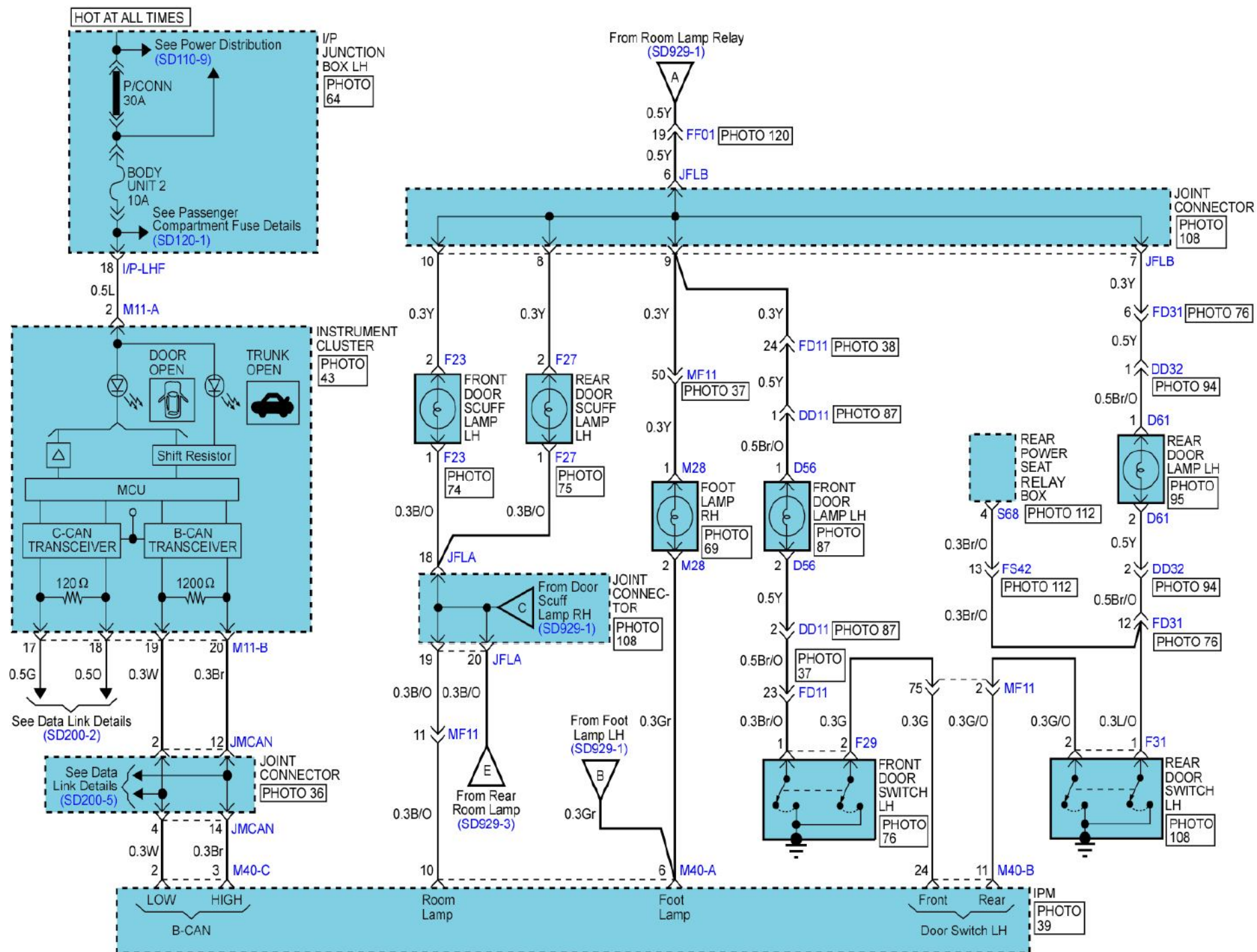
LAUNCH

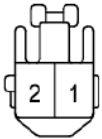
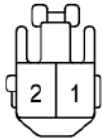
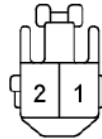
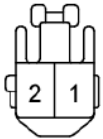

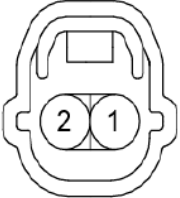
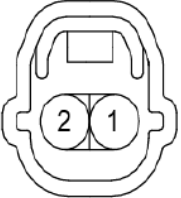
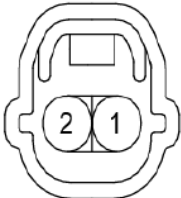
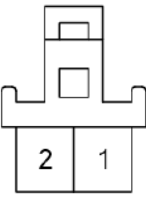
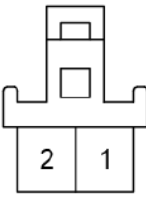
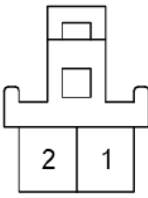
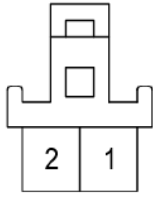
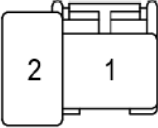
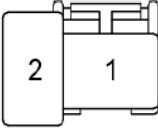
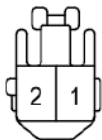
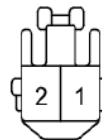
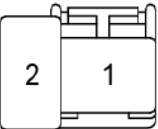
<p>D56</p> 	<p>D58</p> 	<p>D61</p> 	<p>D65</p> 																				
<p>FAM-B</p> <table border="1" data-bbox="300 597 573 772"> <tbody> <tr> <td>6</td> <td>5</td> <td>4</td> <td>3</td> <td>2</td> <td>*</td> </tr> <tr> <td>*</td> <td>11</td> <td>*</td> <td>*</td> <td>8</td> <td>7</td> </tr> <tr> <td>18</td> <td>*</td> <td>16</td> <td>*</td> <td>*</td> <td>13</td> </tr> </tbody> </table>	6	5	4	3	2	*	*	11	*	*	8	7	18	*	16	*	*	13	<p>F23</p> 	<p>F24</p> 	<p>F27</p> 		
6	5	4	3	2	*																		
*	11	*	*	8	7																		
18	*	16	*	*	13																		
<p>F28</p> 	<p>F29</p> 	<p>F30</p> 	<p>F31</p> 																				
<p>F32</p> 	<p>F71</p> 	<p>F72</p> 	<p>M11-A</p> <table border="1" data-bbox="1659 1172 1966 1332"> <tbody> <tr> <td>8</td> <td>7</td> <td>6</td> <td>*</td> <td>4</td> <td>*</td> <td>2</td> <td>1</td> </tr> <tr> <td>16</td> <td>15</td> <td>*</td> <td>13</td> <td>12</td> <td>11</td> <td>*</td> <td>*</td> </tr> </tbody> </table>	8	7	6	*	4	*	2	1	16	15	*	13	12	11	*	*				
8	7	6	*	4	*	2	1																
16	15	*	13	12	11	*	*																
<p>M11-B</p> <table border="1" data-bbox="208 1449 640 1623"> <tbody> <tr> <td>10</td> <td>*</td> <td>*</td> <td>*</td> <td>*</td> <td>*</td> <td>4</td> <td>3</td> <td>2</td> <td>1</td> </tr> <tr> <td>20</td> <td>19</td> <td>18</td> <td>17</td> <td>16</td> <td>*</td> <td>14</td> <td>*</td> <td>12</td> <td>*</td> </tr> </tbody> </table>	10	*	*	*	*	*	4	3	2	1	20	19	18	17	16	*	14	*	12	*	<p>M27</p> 	<p>M28</p> 	<p>M32</p> 
10	*	*	*	*	*	4	3	2	1														
20	19	18	17	16	*	14	*	12	*														

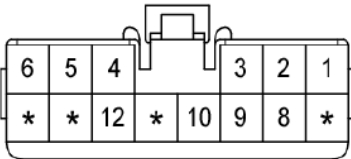
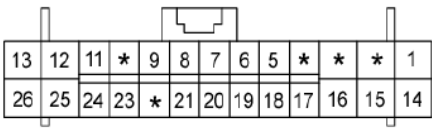
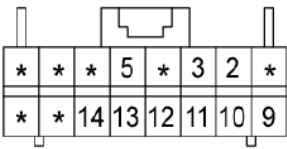
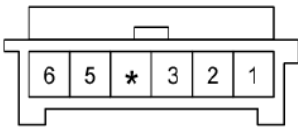
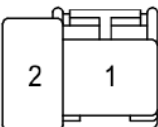
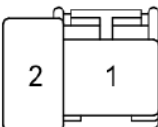
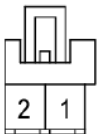
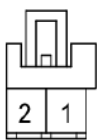
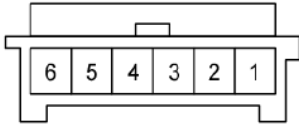
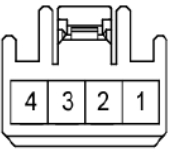
<p>M33</p> 	<p>M40-A</p> 	<p>M40-B</p> 	<p>M40-C</p> 
<p>R01</p> 	<p>R03</p> 	<p>R04</p> 	<p>R05</p> 
<p>R06</p> 	<p>R11</p> 	<p>R21</p> 	<p>S68</p> 