

2010现代劳恩斯驾驶席电动座椅电路图

摘要:

该文档主要描述2010现代劳恩斯驾驶席电动座椅电路图。

关键字:

2010 现代 劳恩斯 电路图 座椅 驾驶席电动座椅

LAUNCH





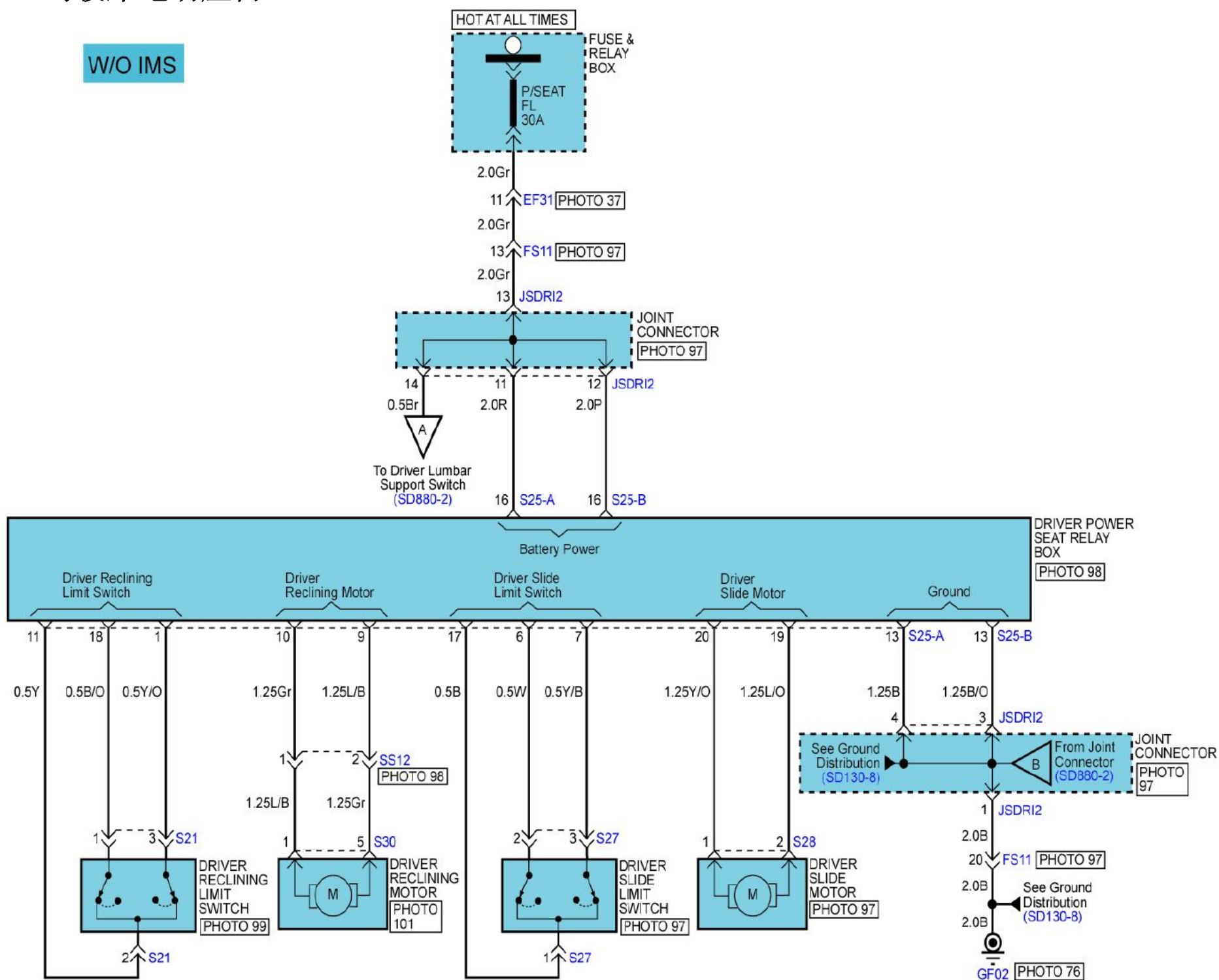

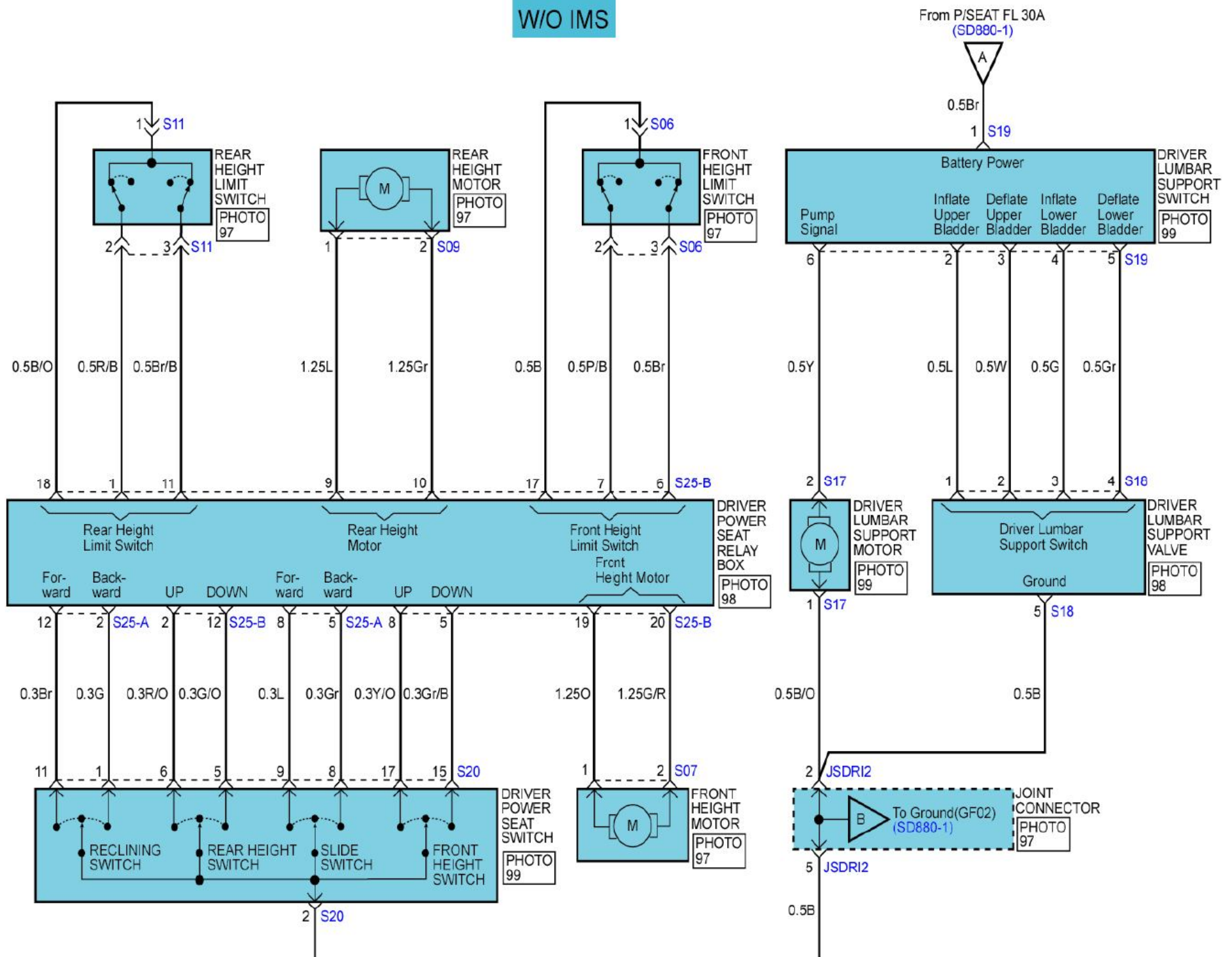

1. 驾驶席电动座椅

W/O IMS

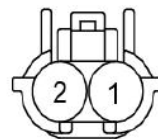

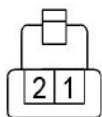
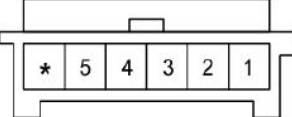
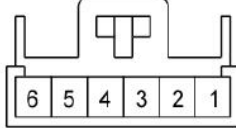
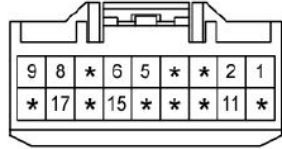
W/O IMS

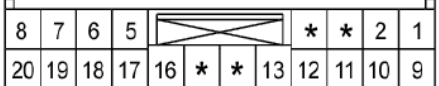
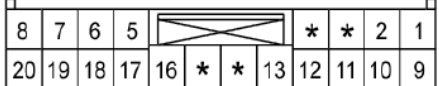

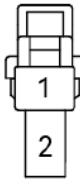
<p>S06</p> 	<p>S07</p> 	<p>S09</p> 	<p>S11</p> 
<p>S17</p> 	<p>S18</p> 	<p>S19</p> 	<p>S20</p> 
<p>S21</p> 	<p>S25-A</p> 	<p>S25-B</p> 	<p>S27</p> 
<p>S28</p> 	<p>S30</p> 