

2010 CX-7 安全气囊系统电路图

摘要:

该文档主要描述 2010 年 CX-7 的安全气囊系统电路图。

关键字:

2010 马自达 CX-7 电路图 符号 接地 连接器 端子 线束 安全气囊

LAUNCH

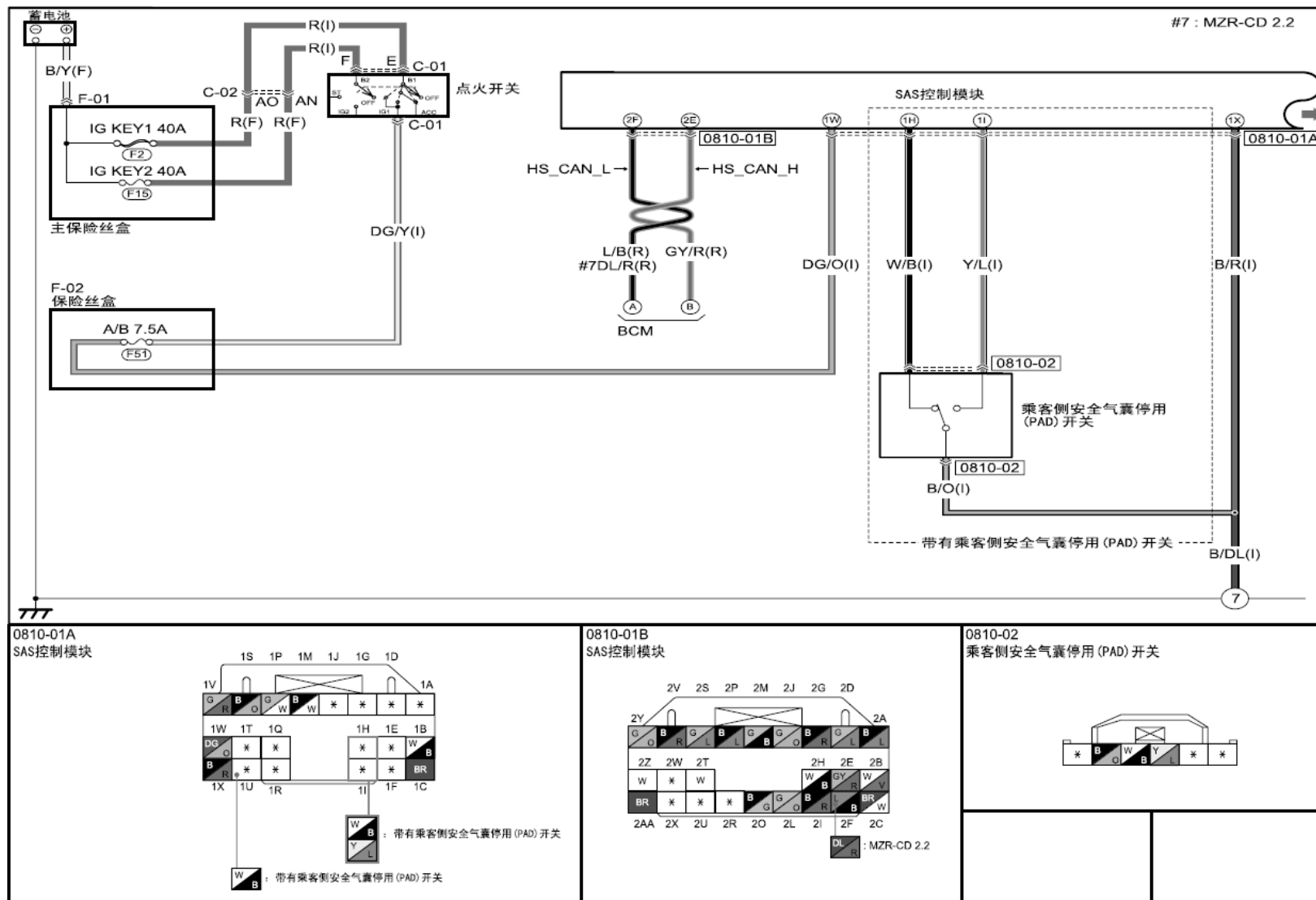

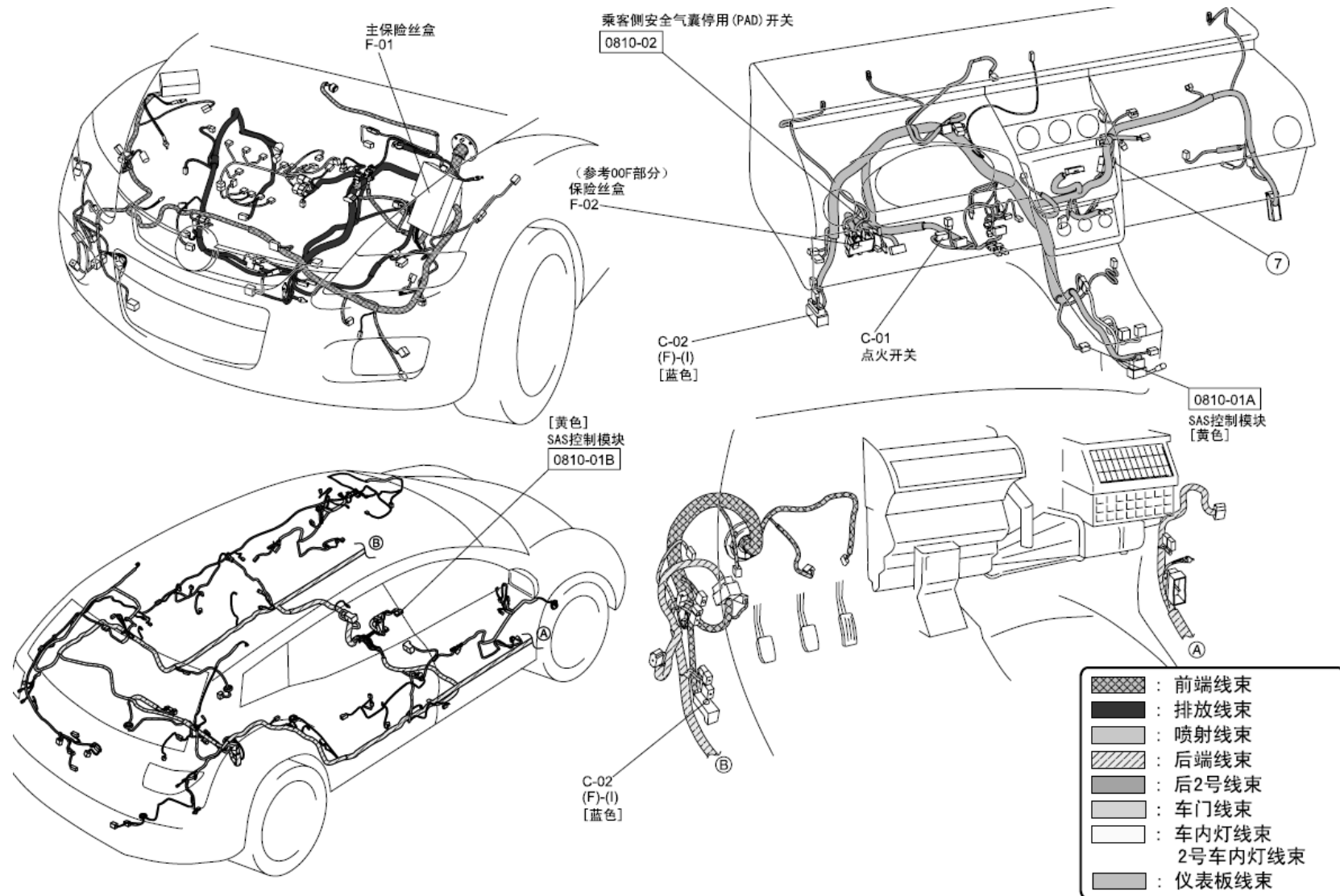

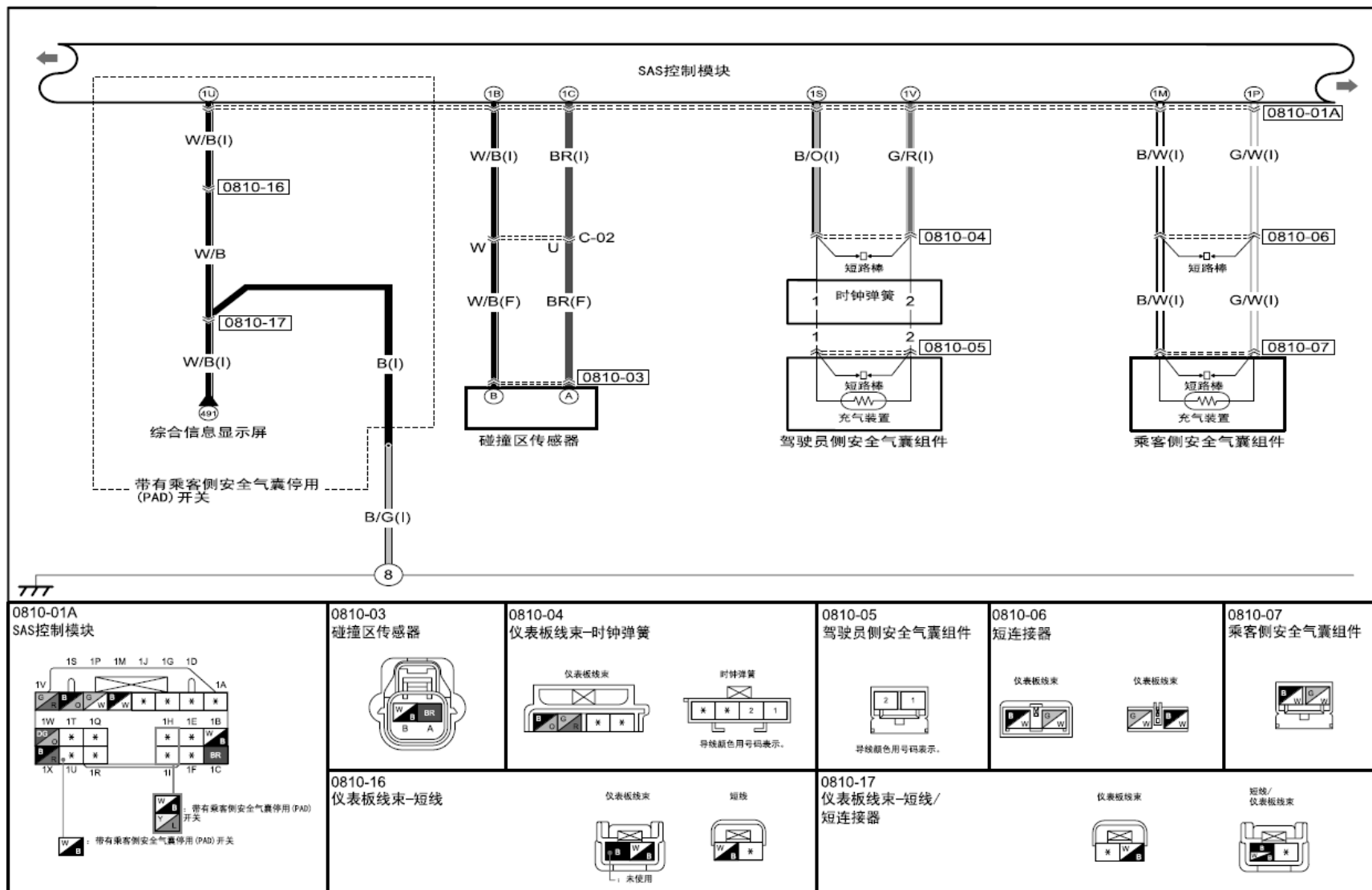

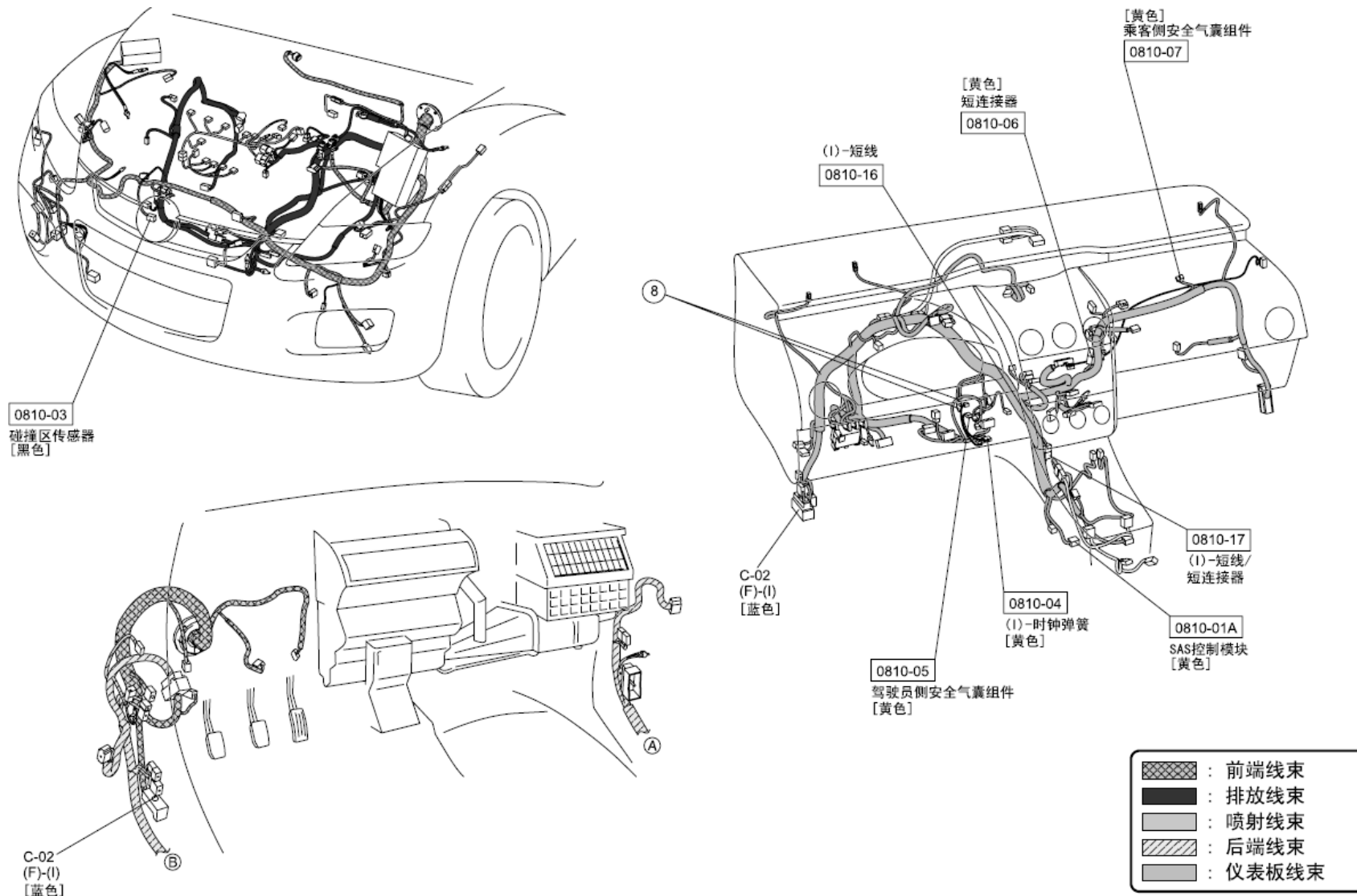

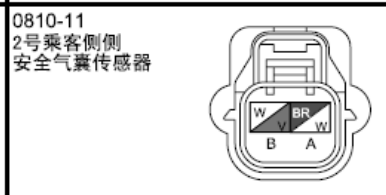
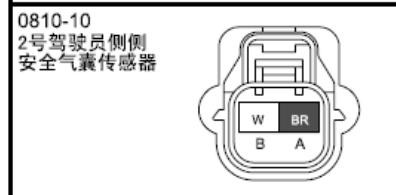
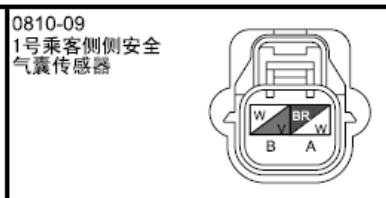
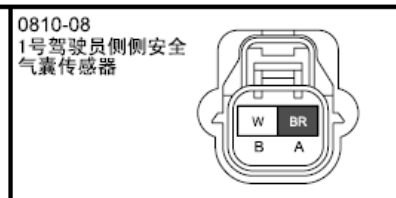
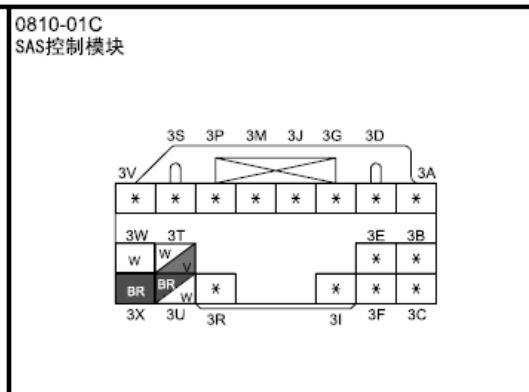
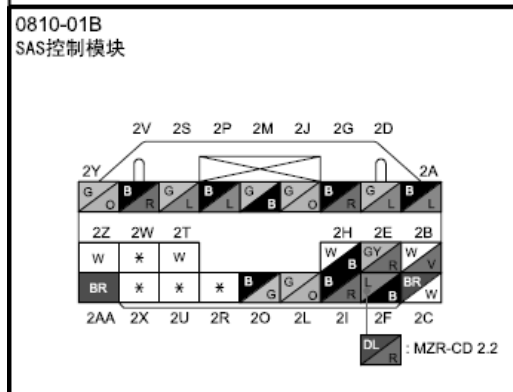
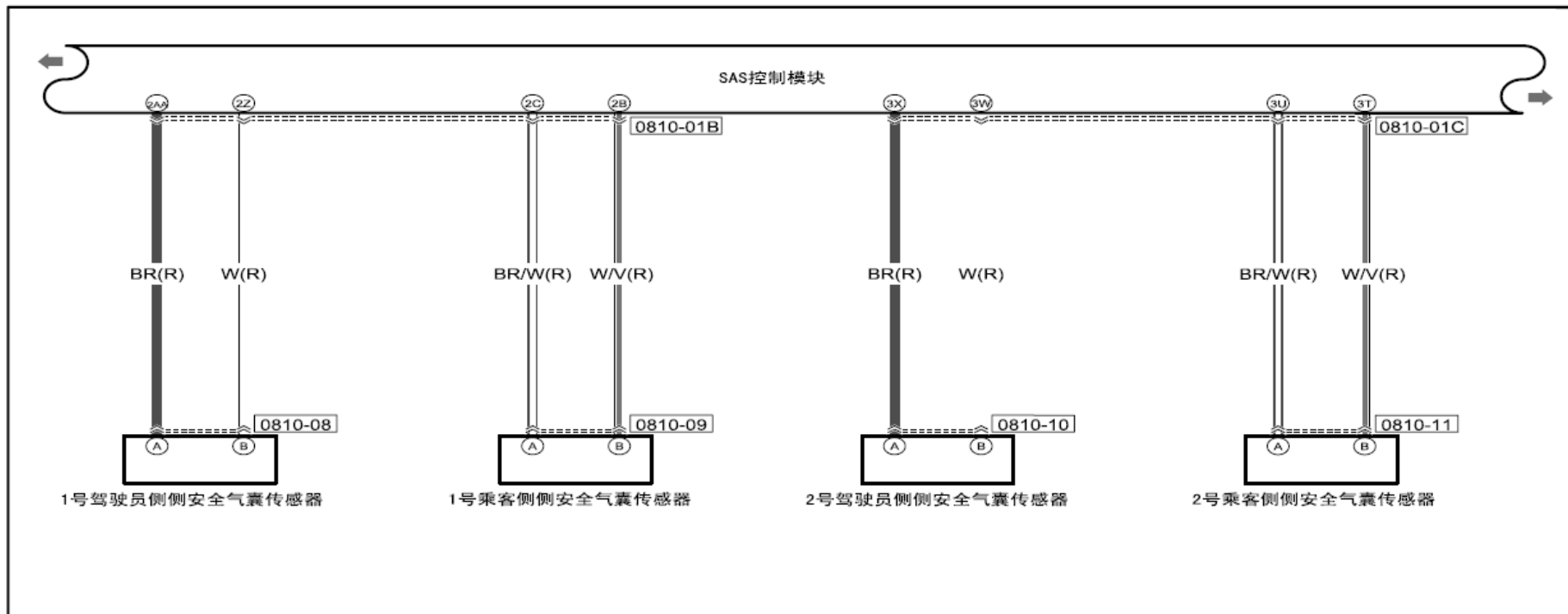

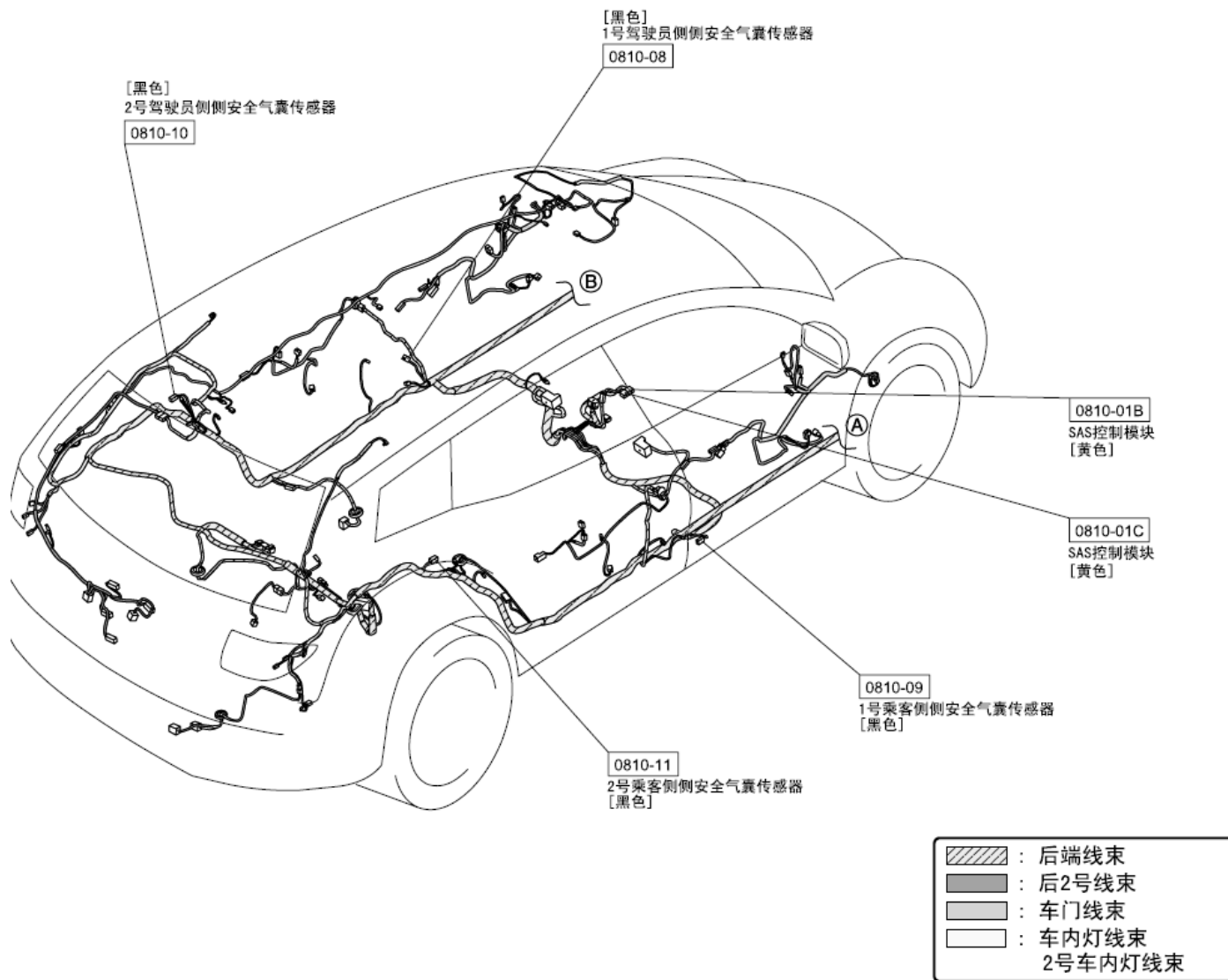

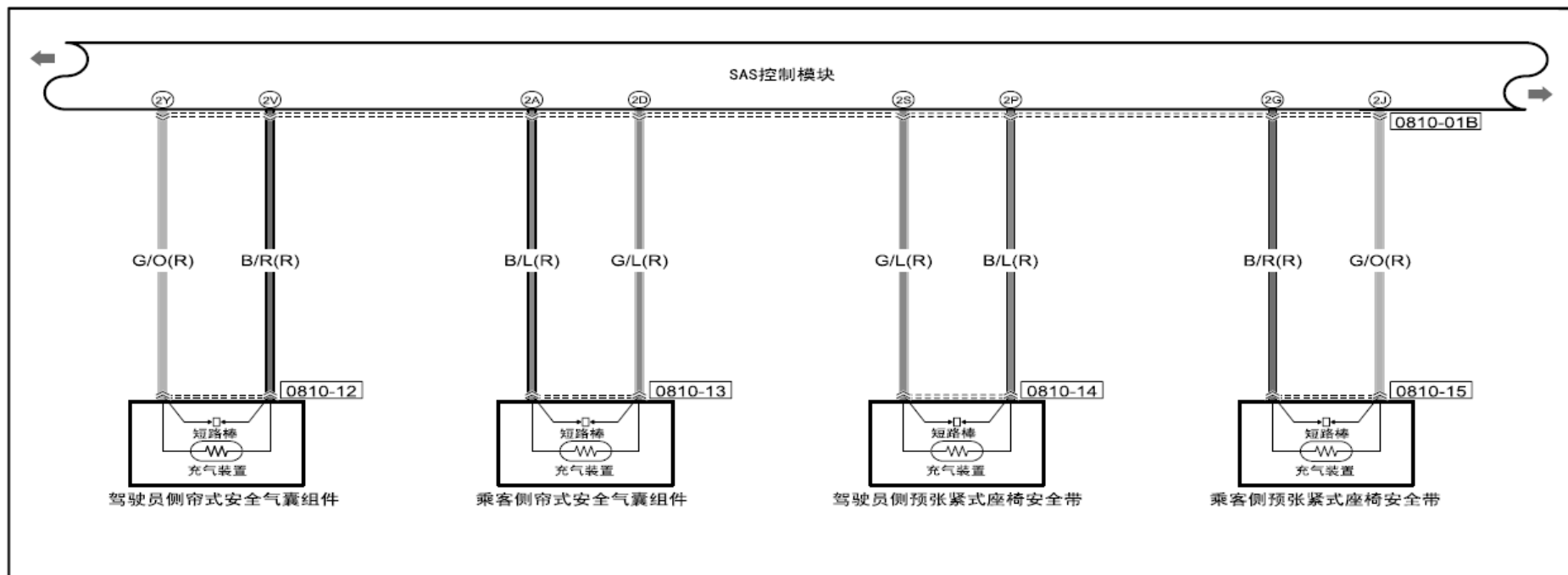

<p>0810-01B SAS控制模块</p>	<p>0810-12 驾驶员侧帘式安全气囊组件</p>	<p>0810-13 乘客侧帘式安全气囊组件</p>	
	<p>0810-14 驾驶员侧预张紧式座椅安全带</p>	<p>0810-15 乘客侧预张紧式座椅安全带</p>	

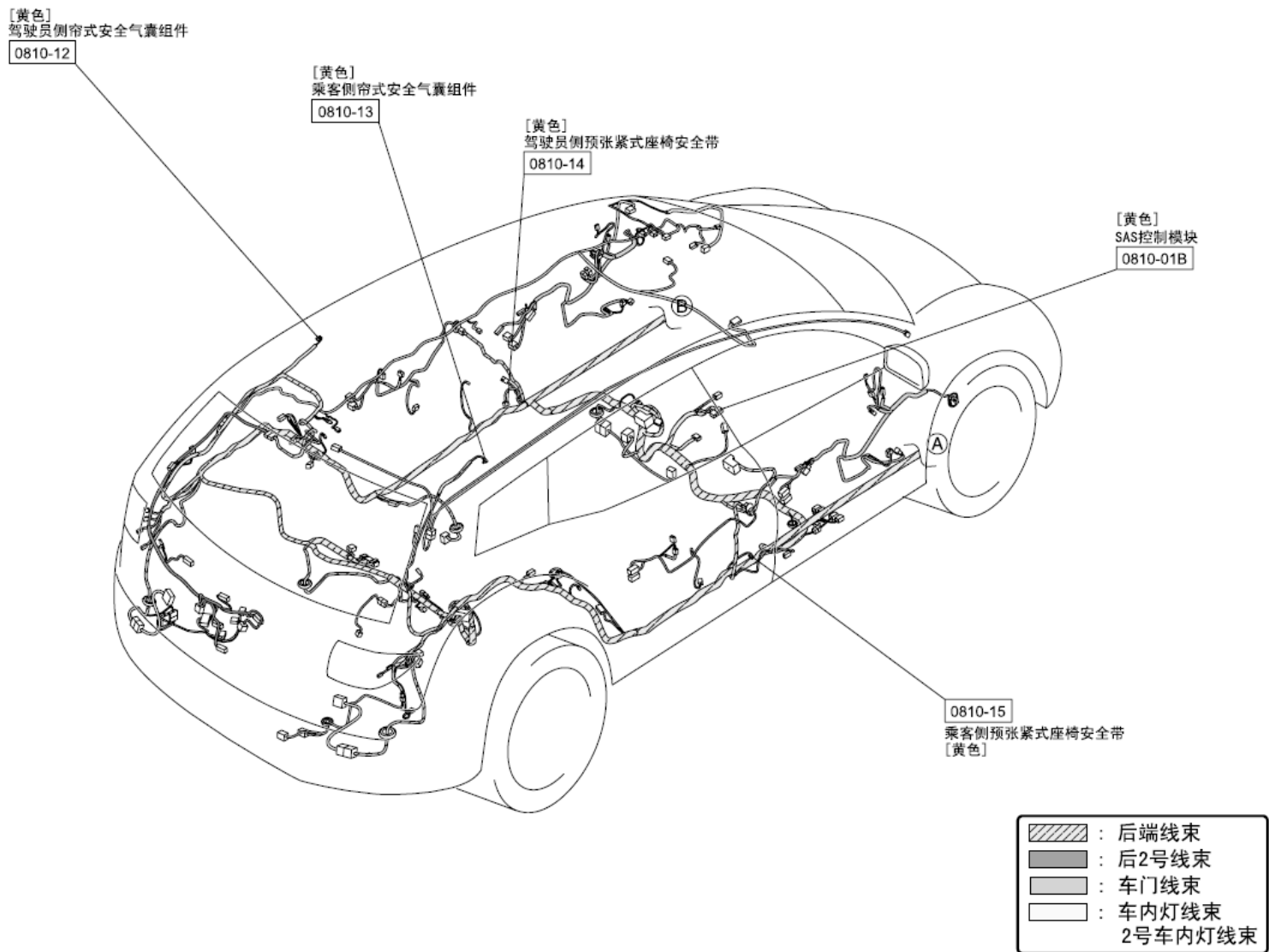

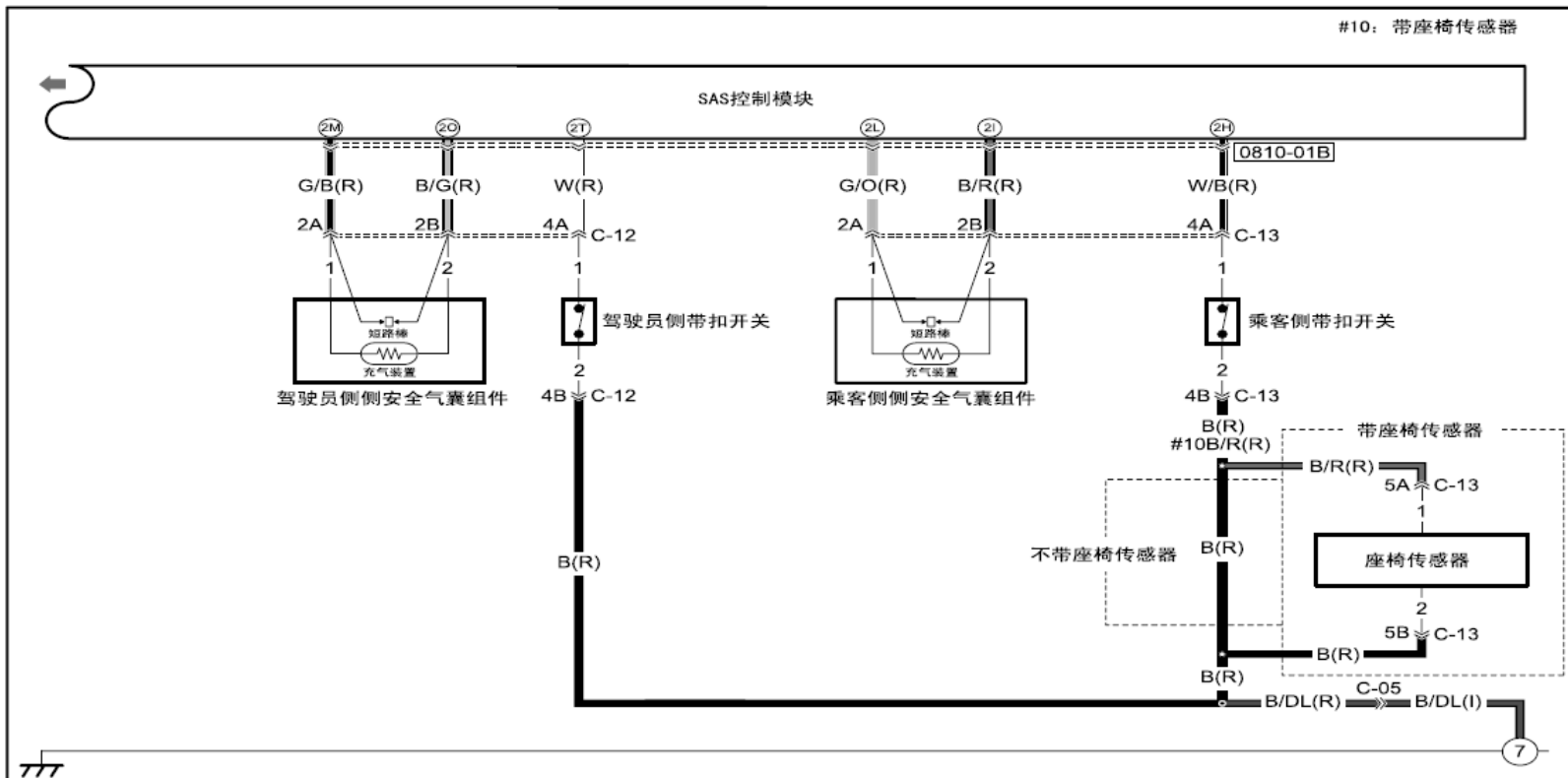

777

