

5. 接地点布置

5.1 接地点布置图

发动机舱接地点布置图

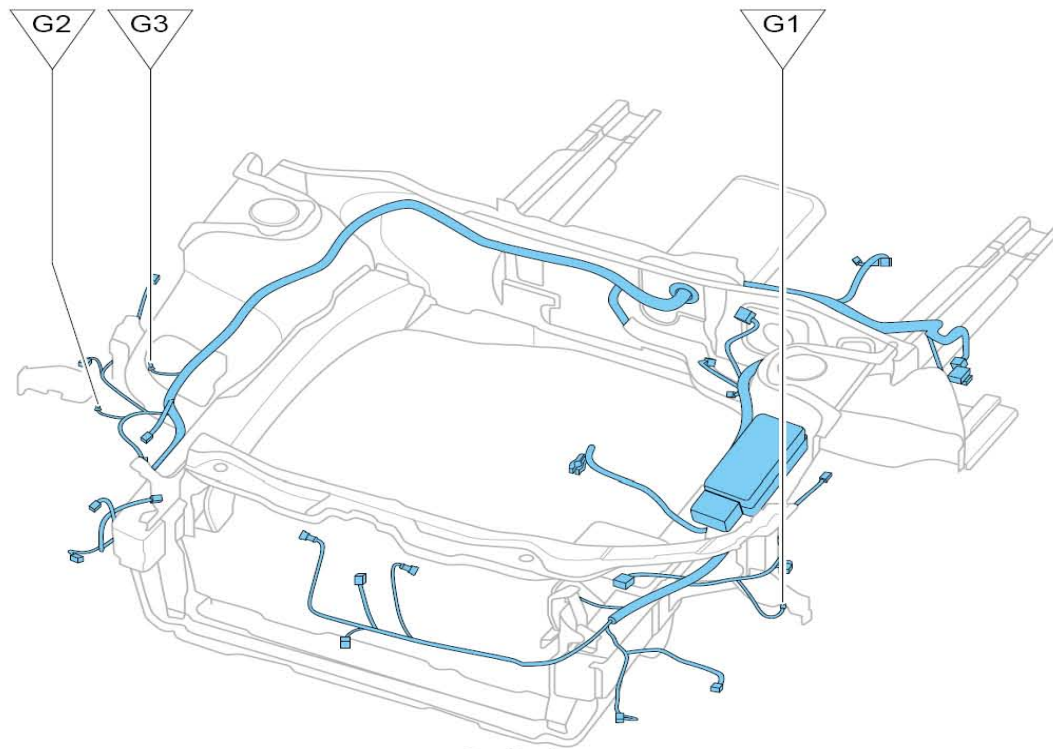

发动机舱接地点布置图(续)

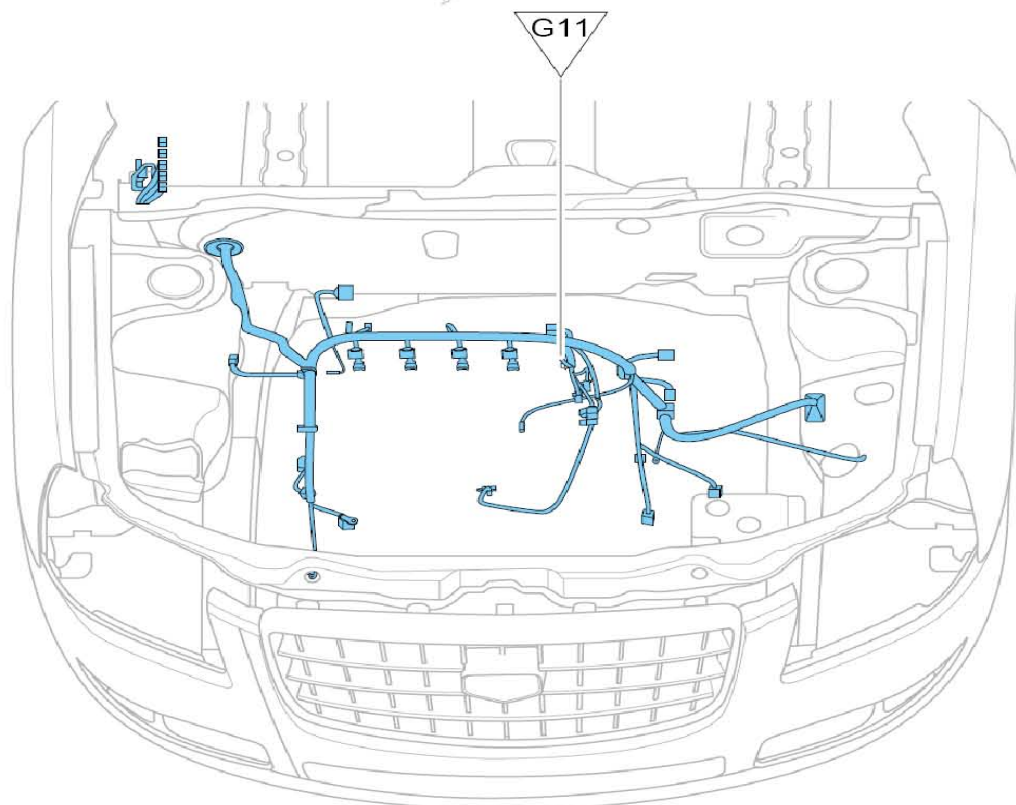

仪表板接地点布置图

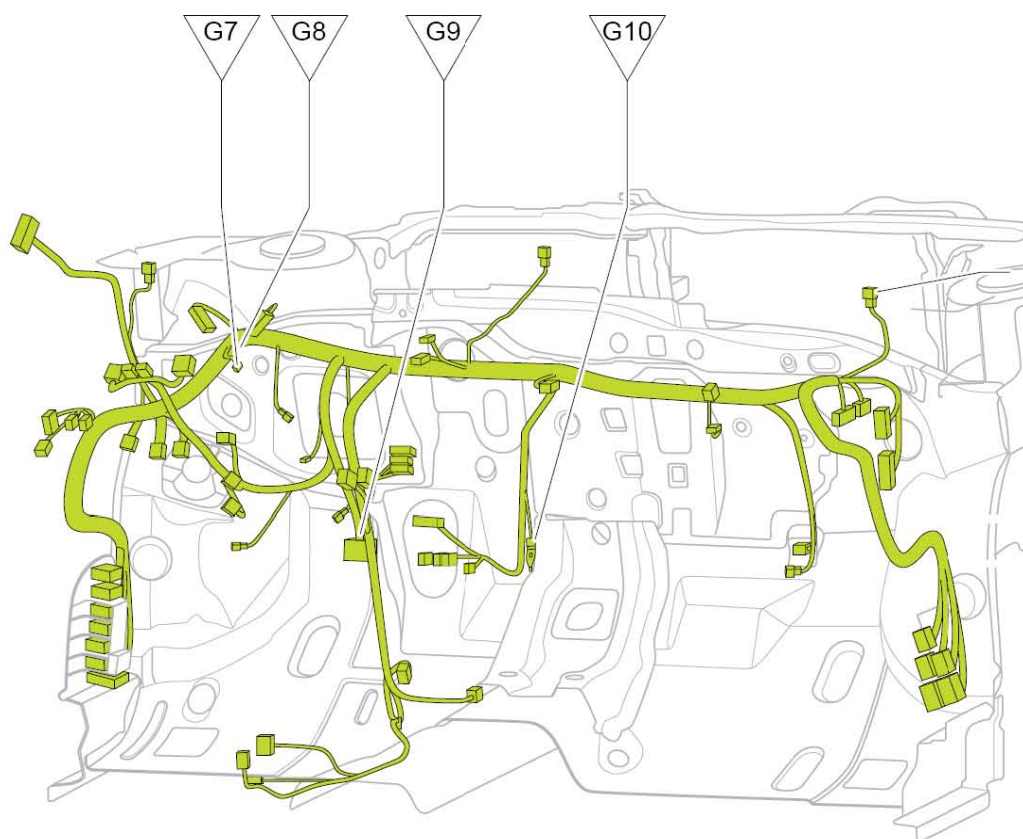

底板接地点布置图(左侧)



底板接地点布置图(右侧)



5.2 接地点线路图

接地线路图1 (G1、G5)

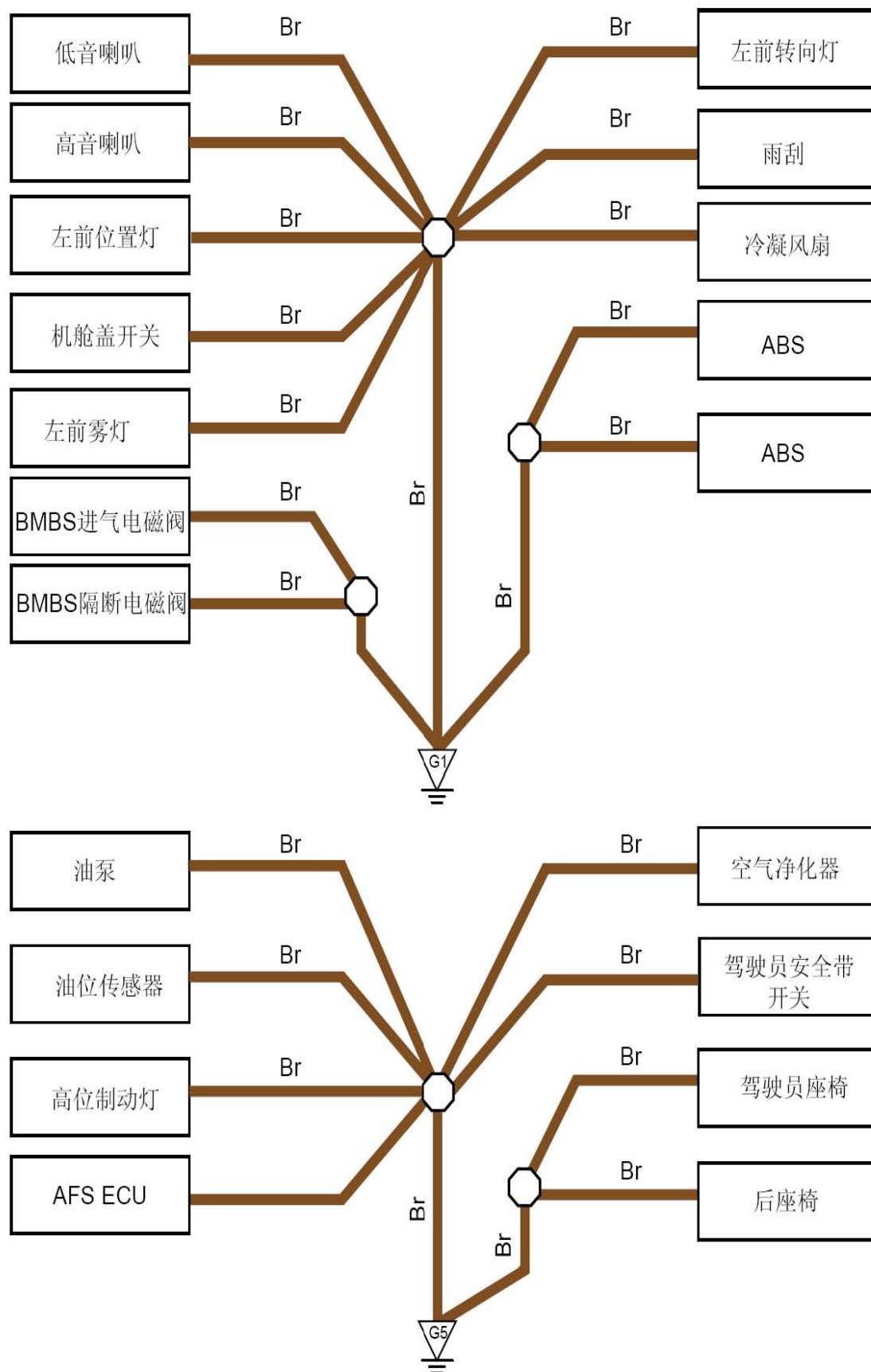

接地线路图2 (G3, G9, G7, G11)

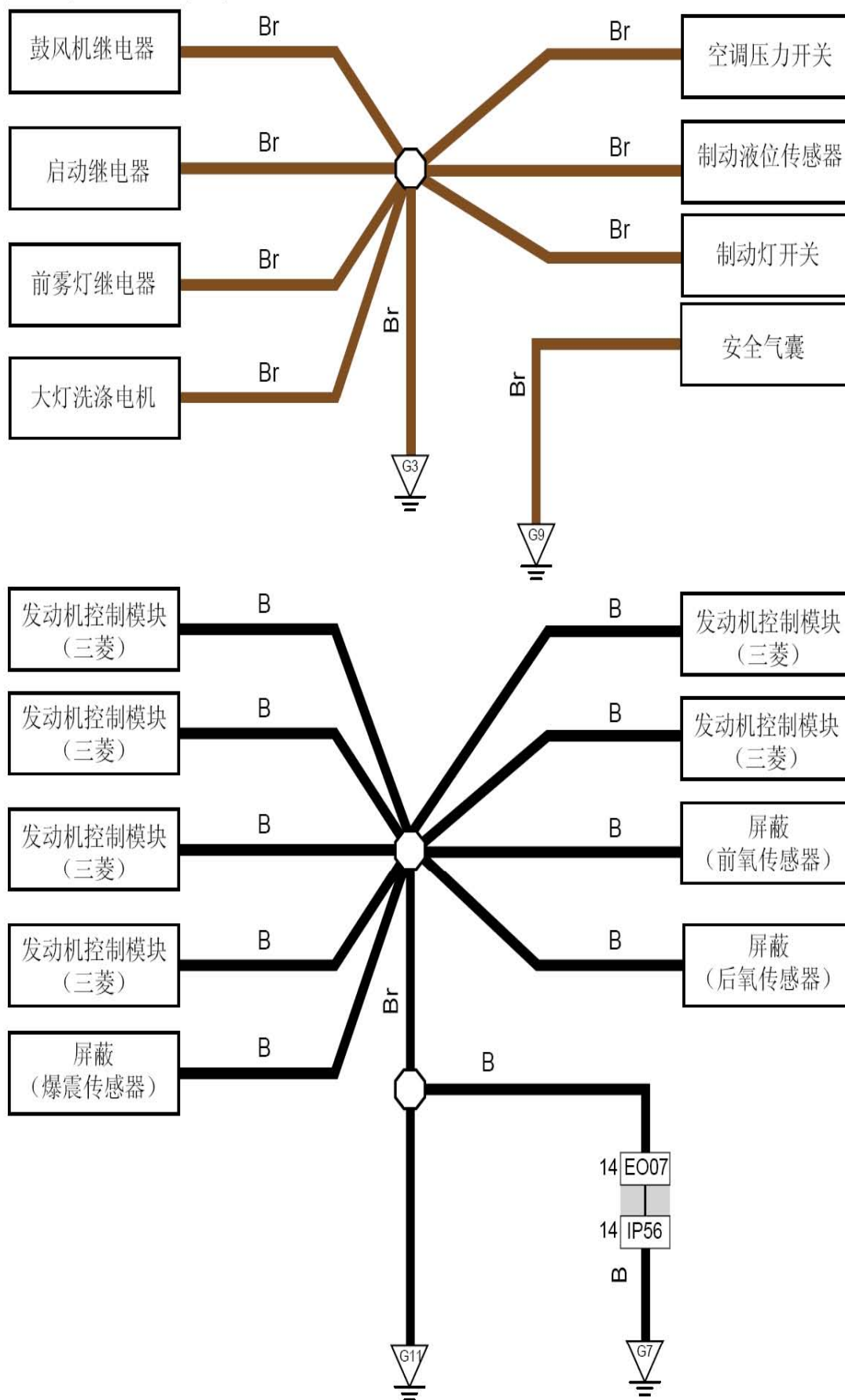

接地线路图3 (G4, G6)

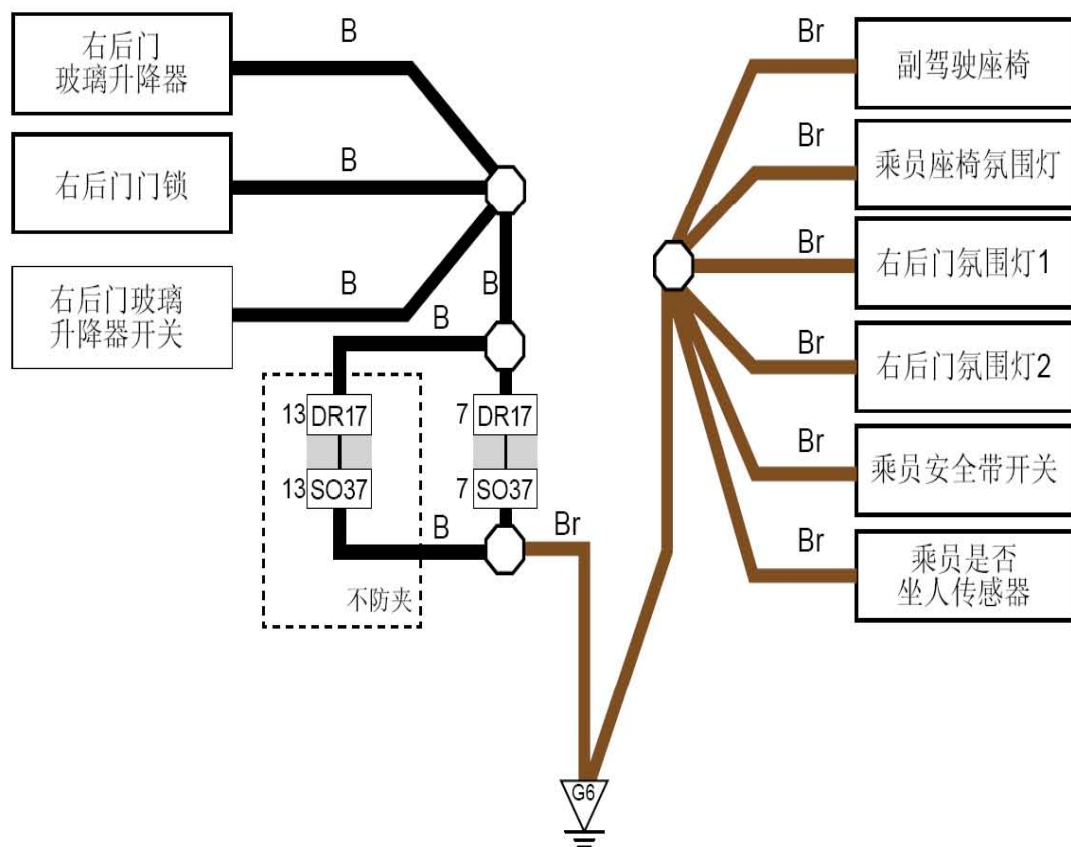
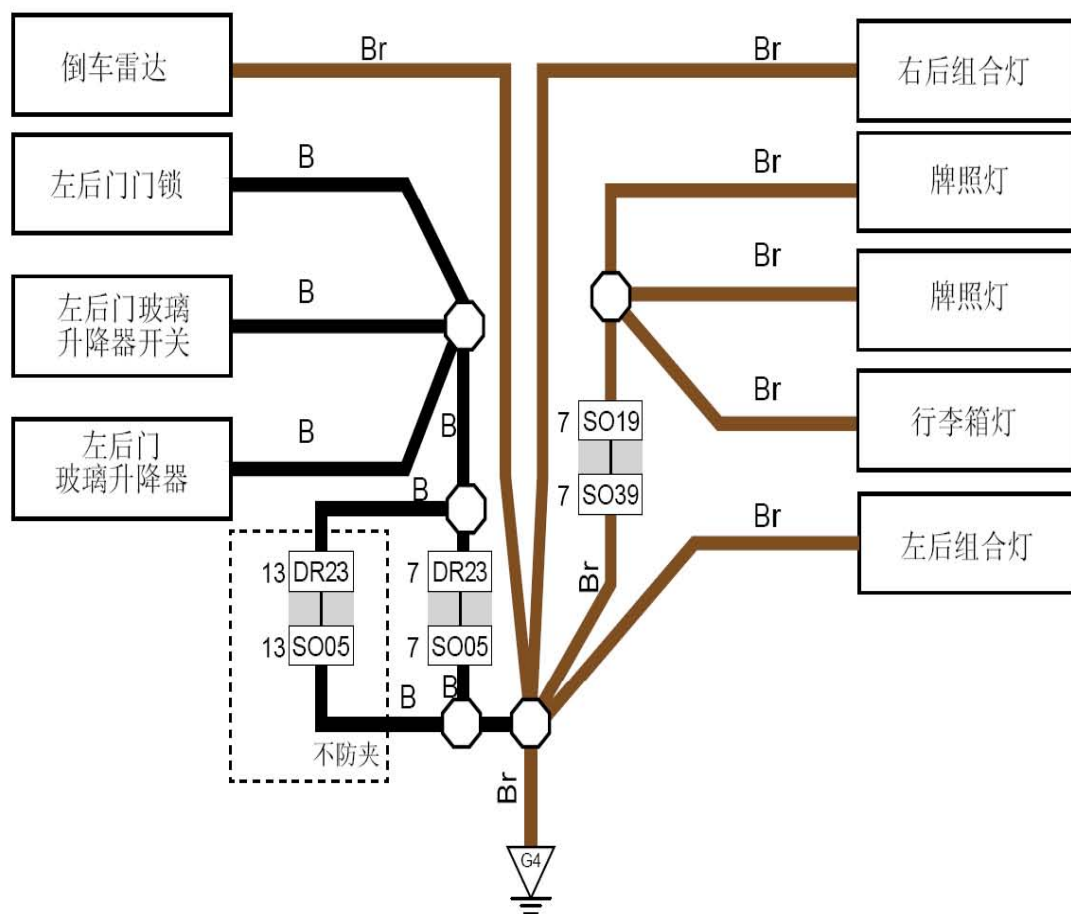

接地线路图4 (G7)

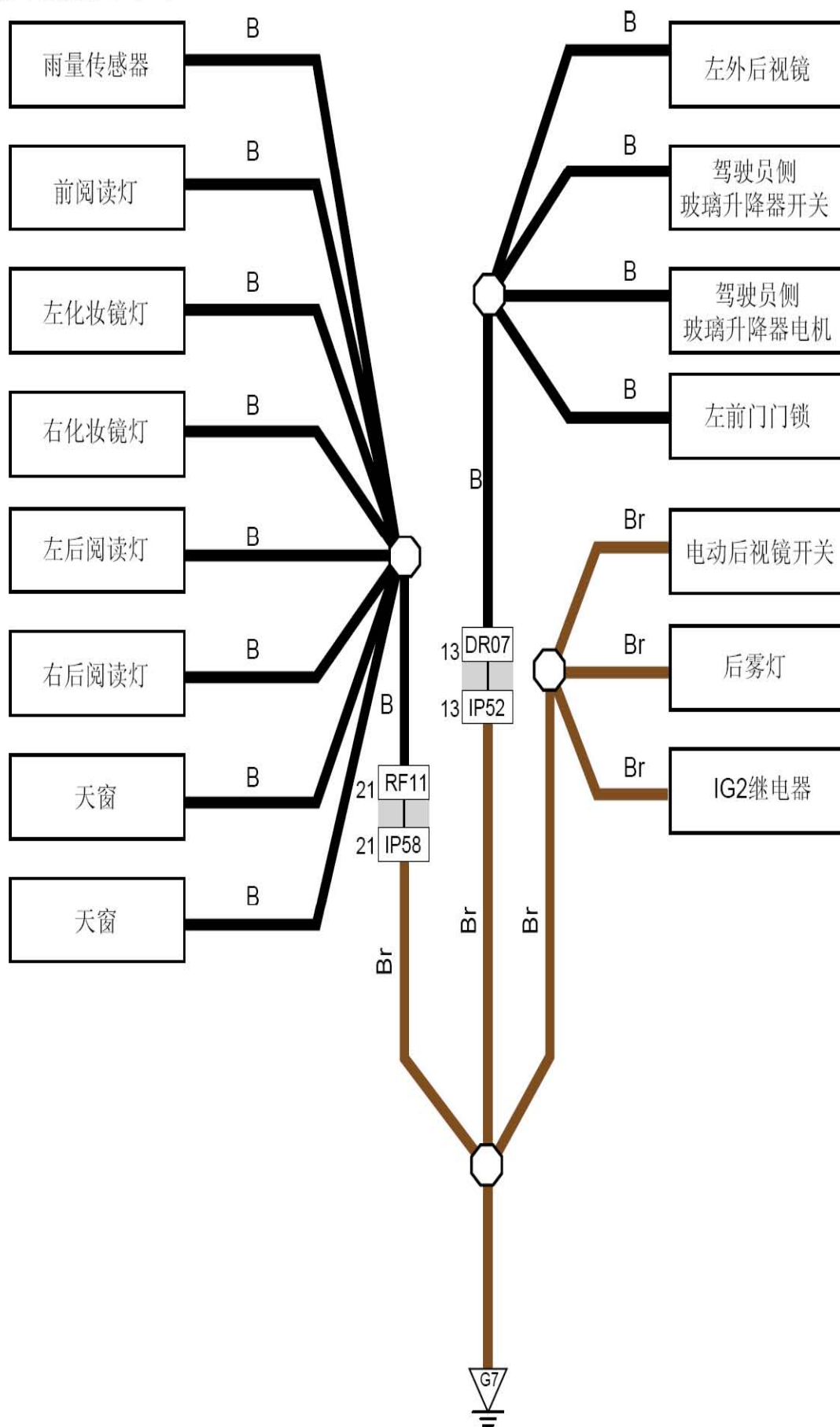

接地线路图5 (G8)

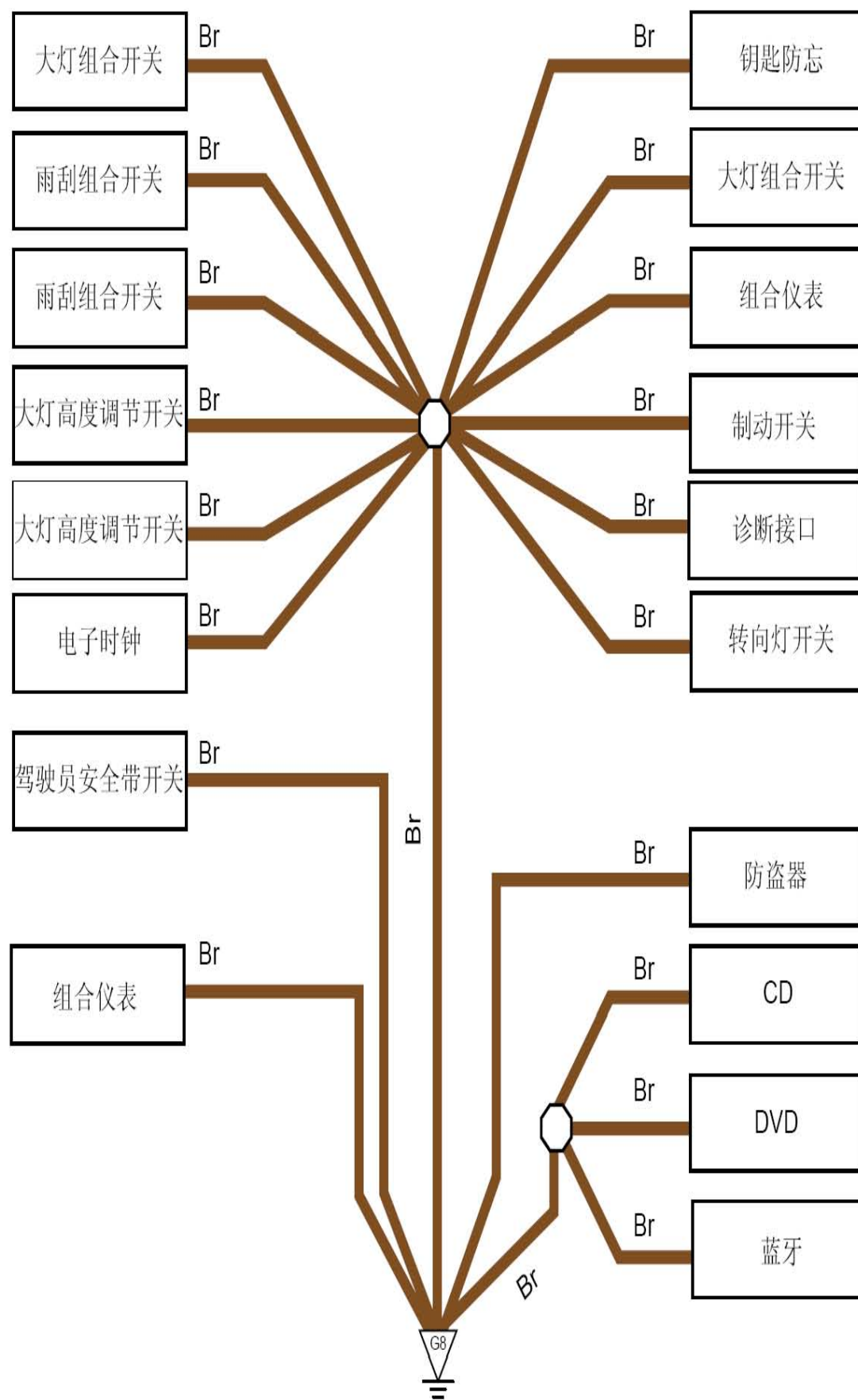

接地线路图6 (G10)

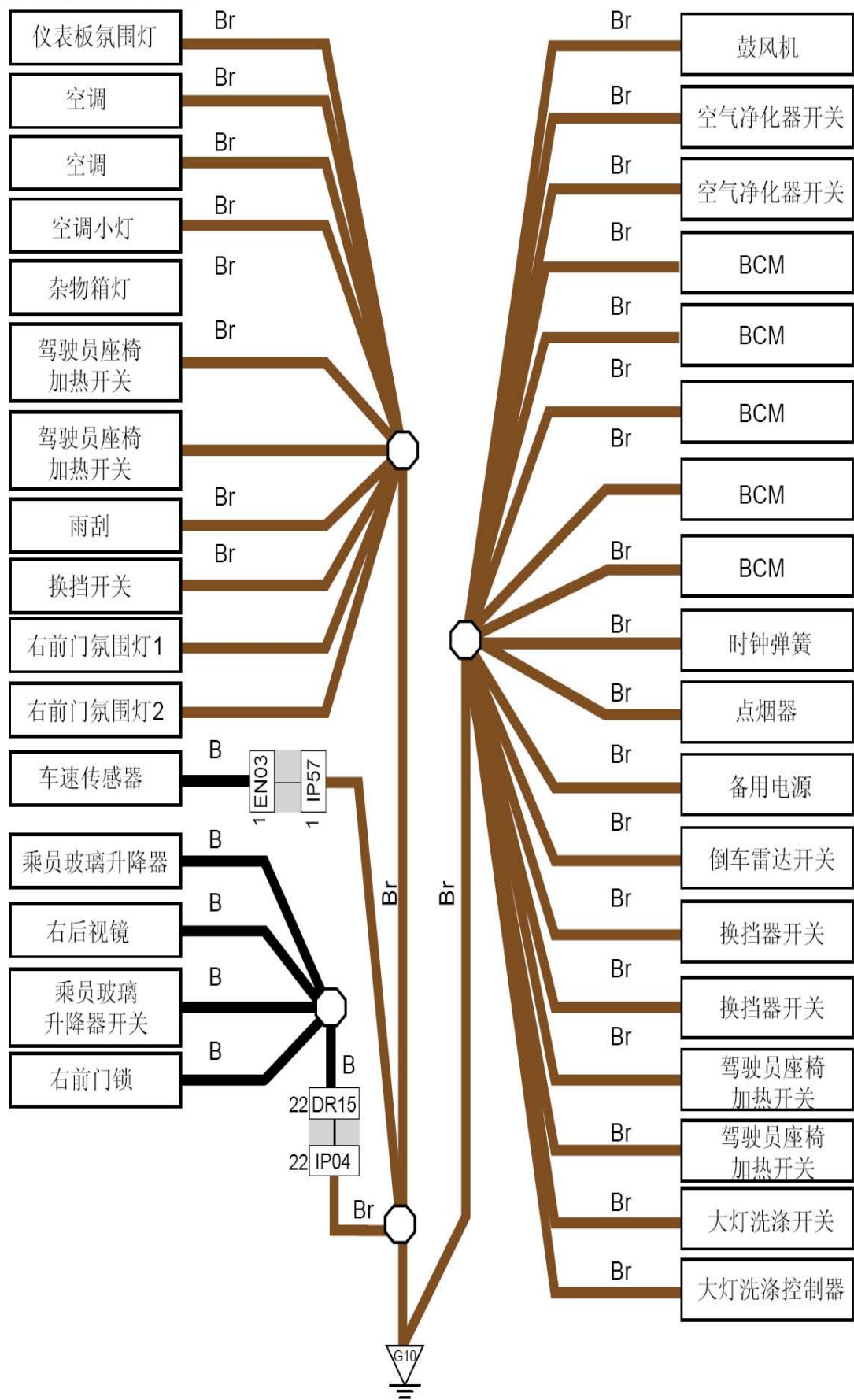

接地线路图7 (G2、G7、G11)

