

2.16 仪表系统

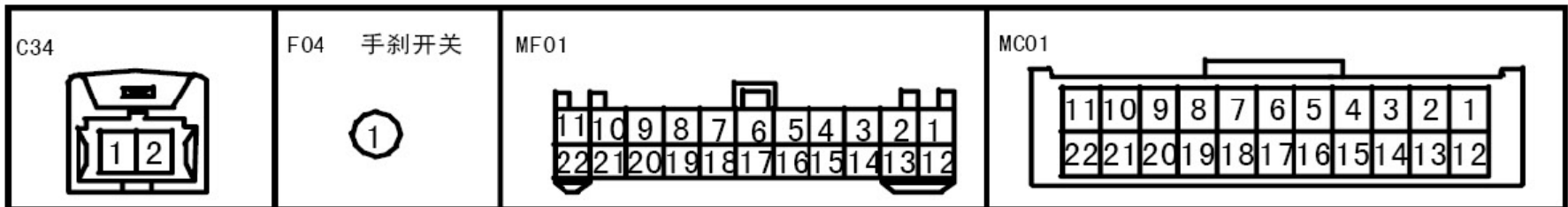

# 仪表系统-2

P-2

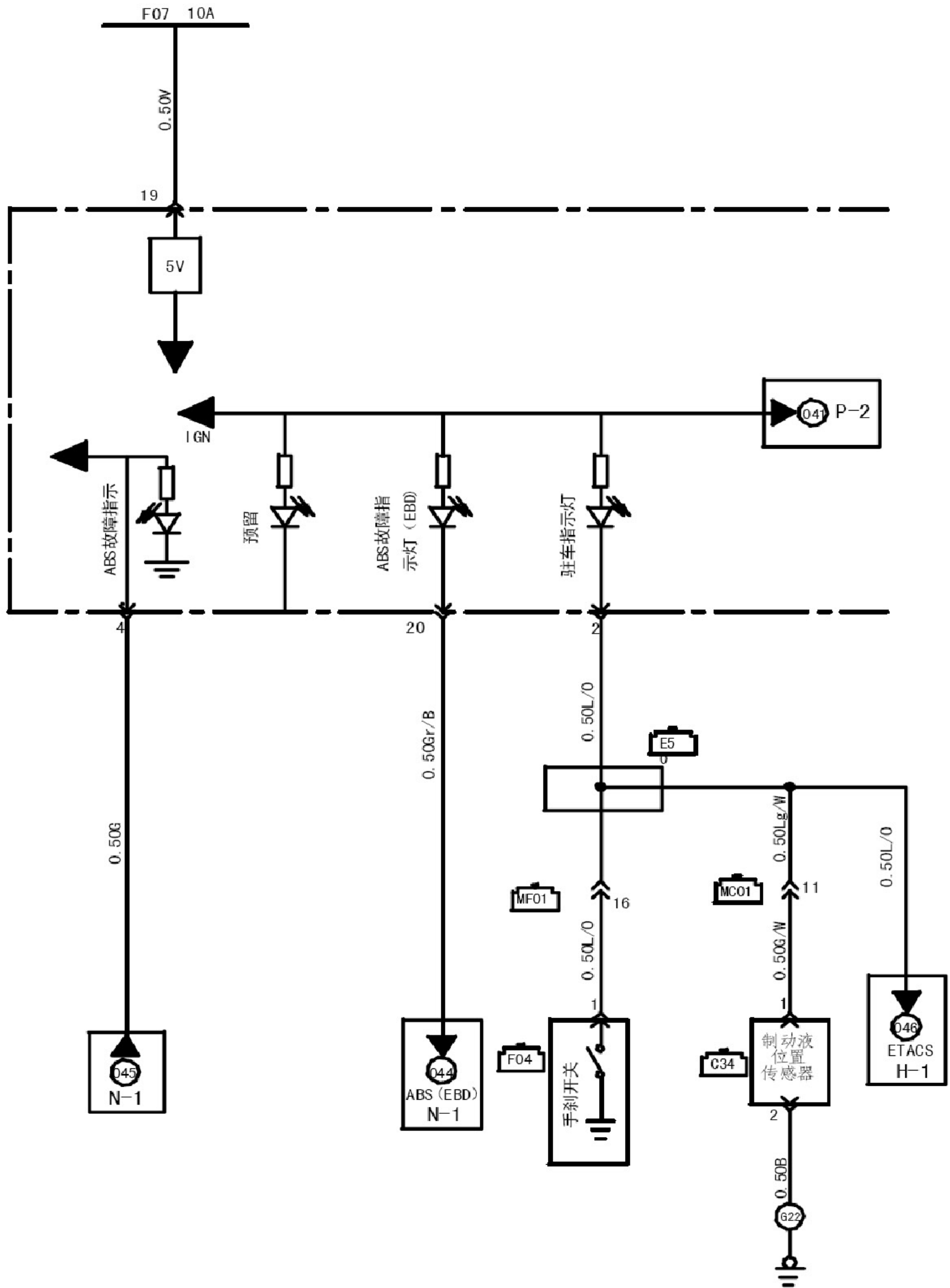
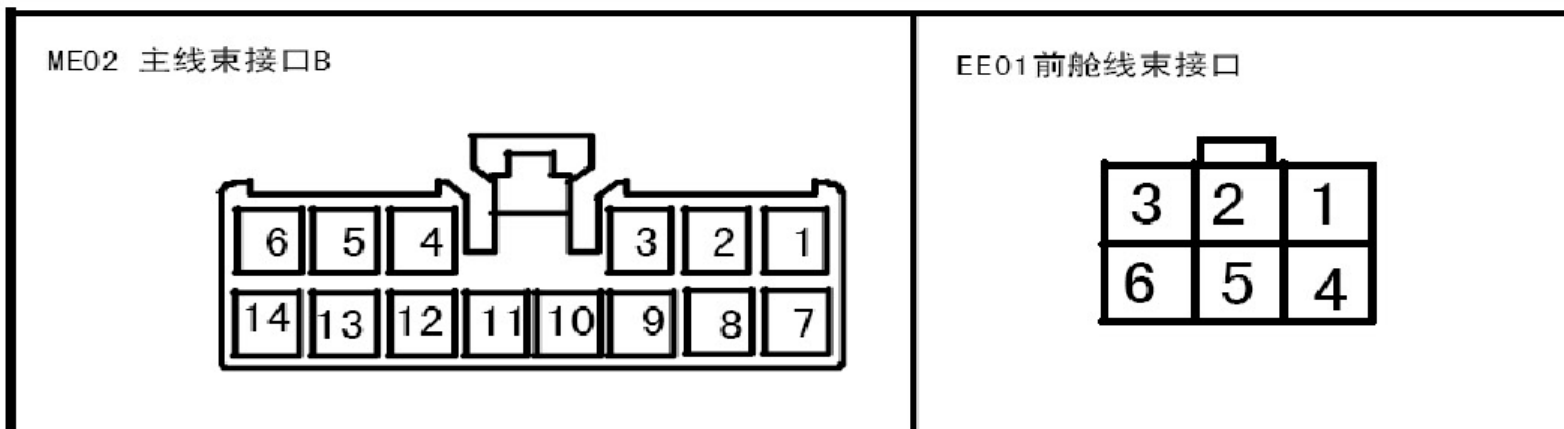
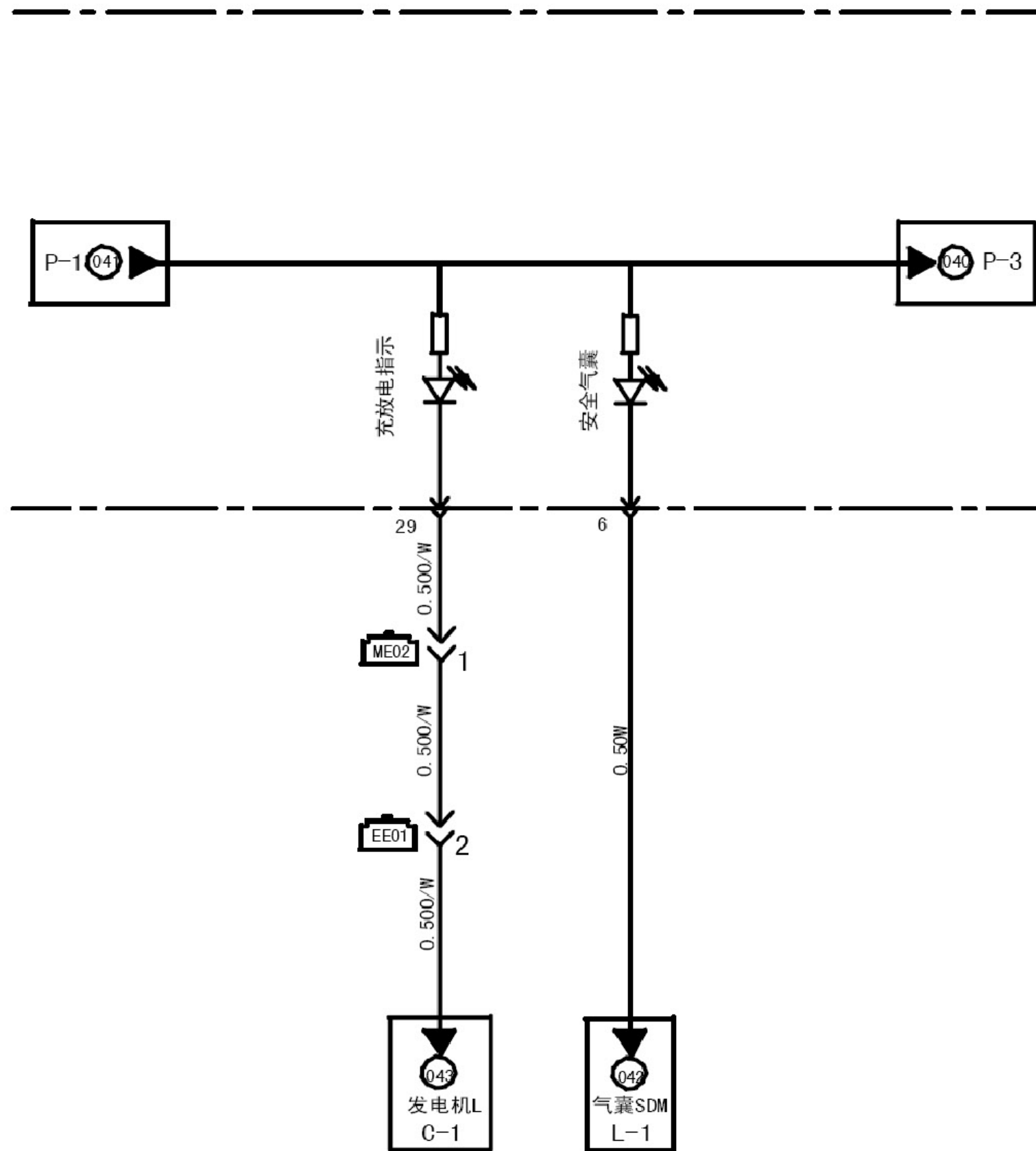

# 仪表系统-3

P-3

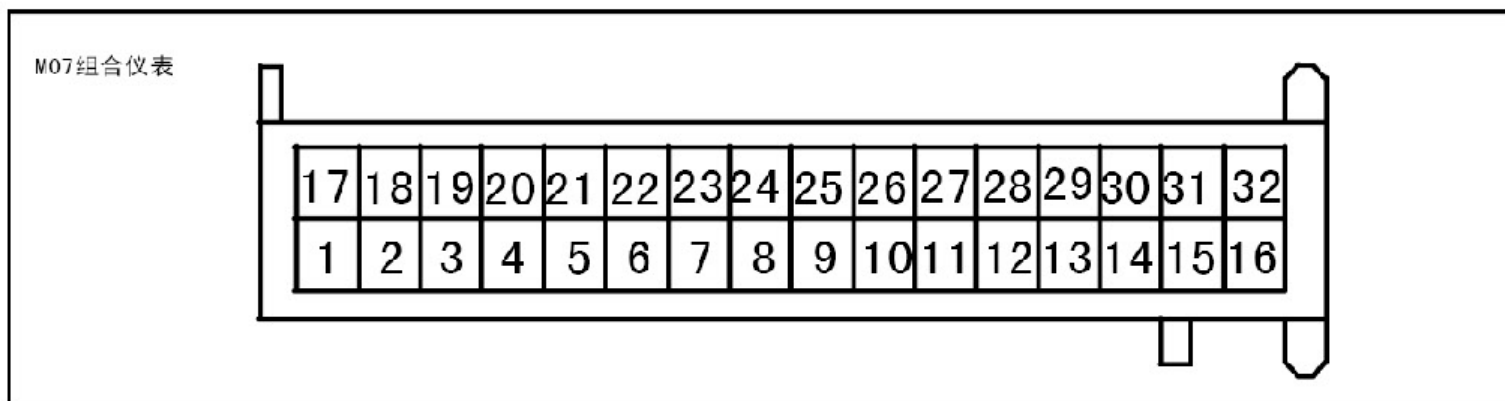
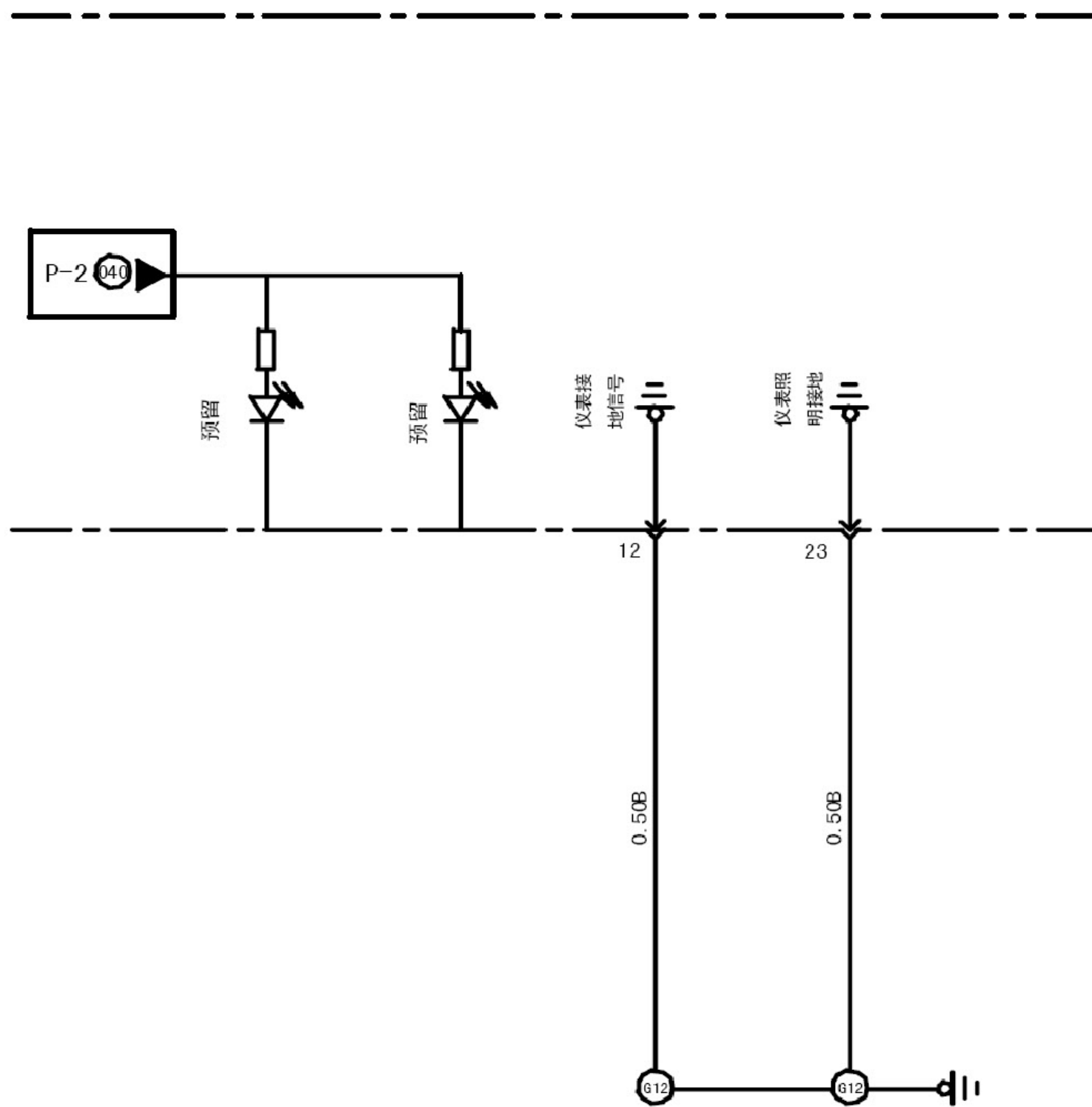

# 仪表系统-4

P-4

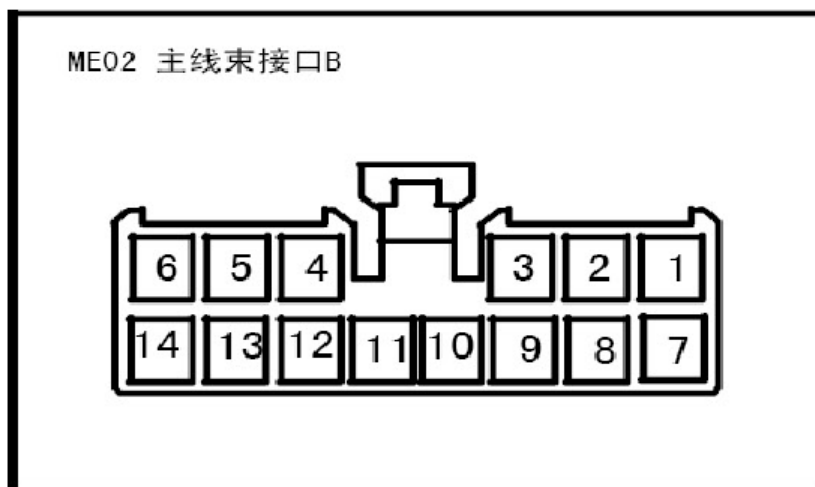
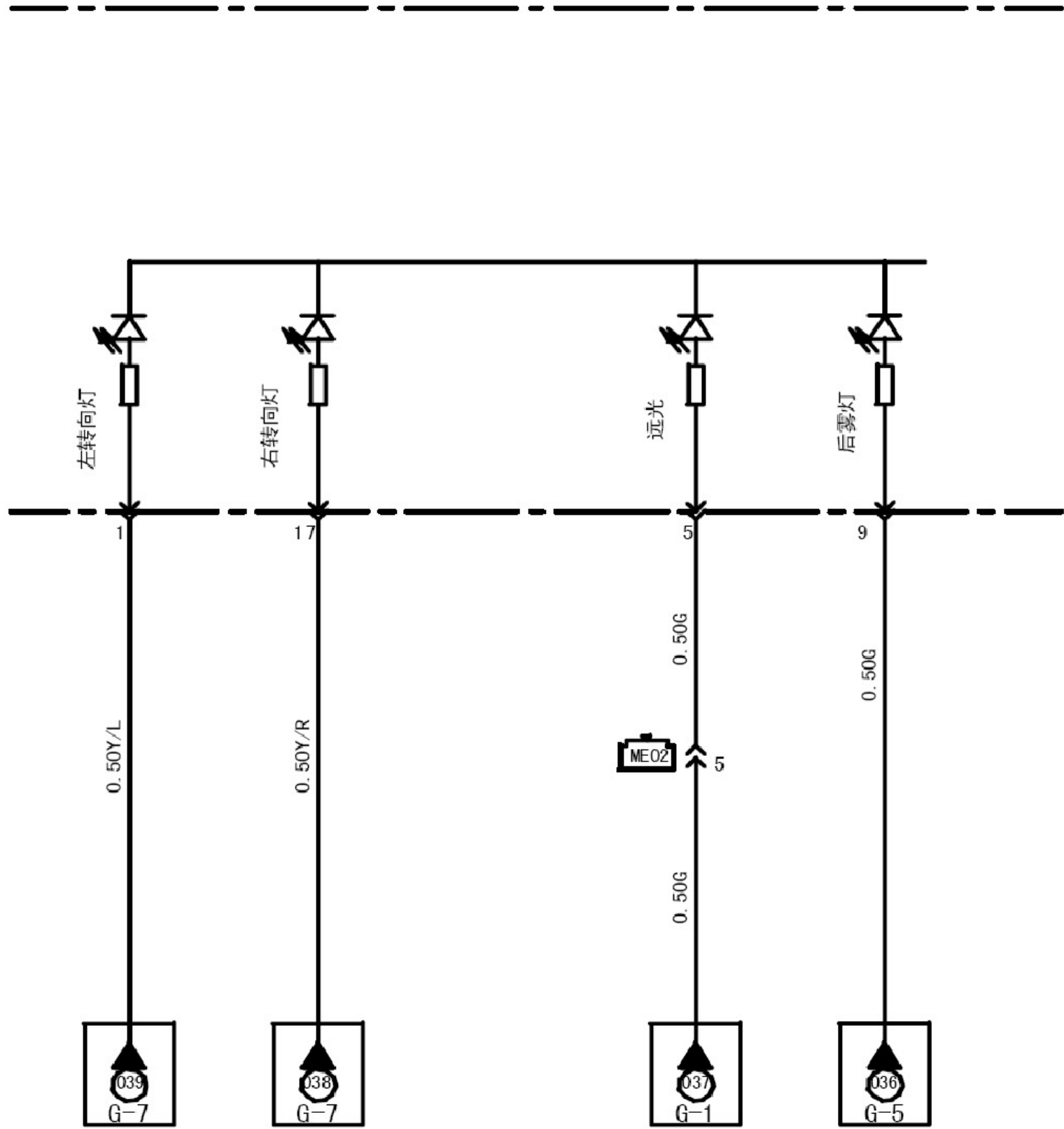

仪表系统-5

P-5

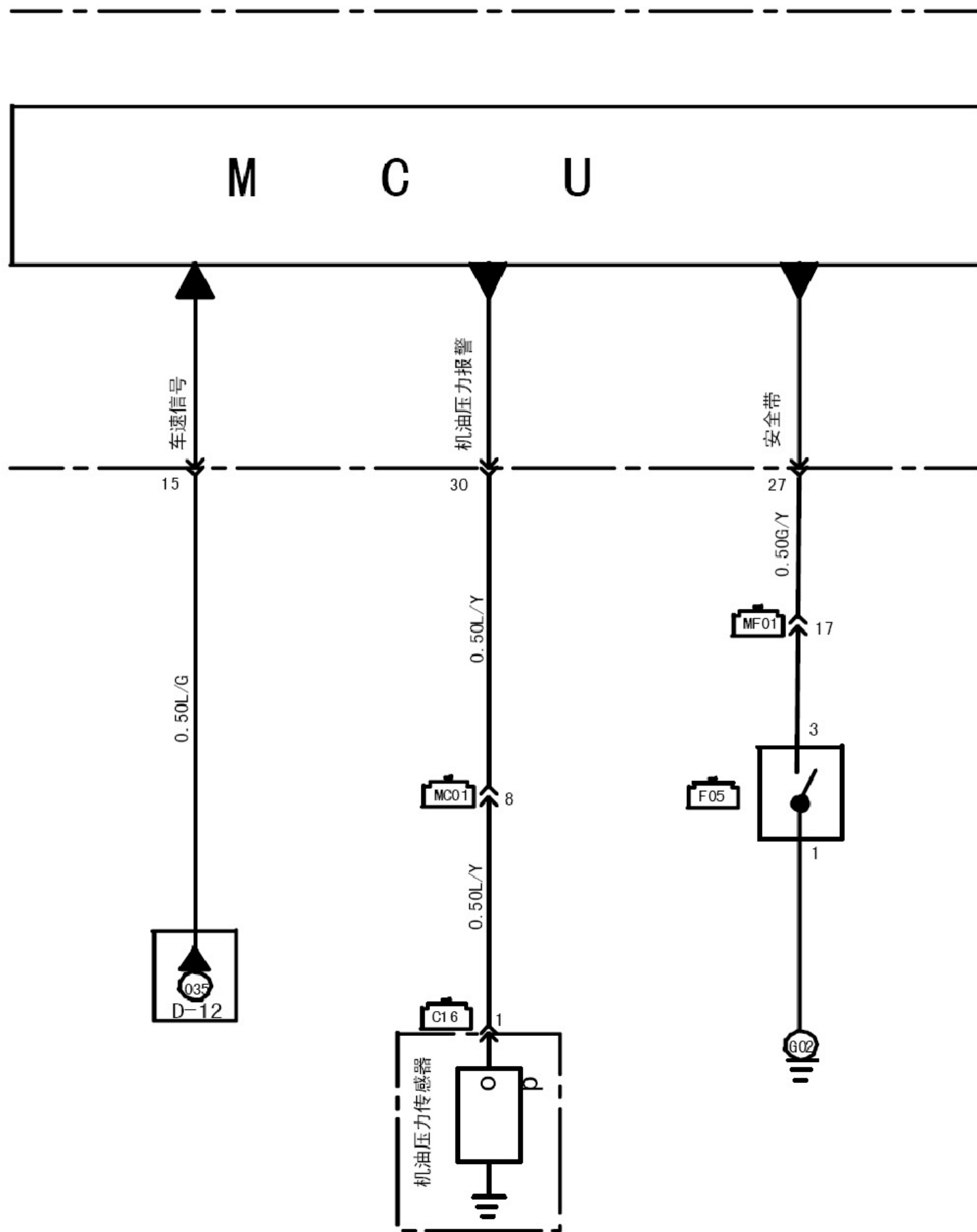

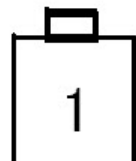
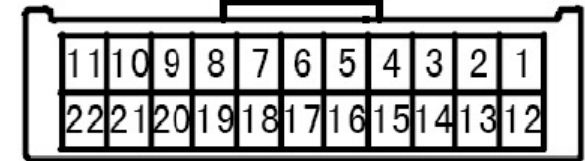
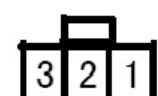
<p>C16 机油压力开关</p> 	<p>MC01 主线束接口</p> 	<p>F05 安全带开关</p> 
---	--	--

仪表系统-6

P-6

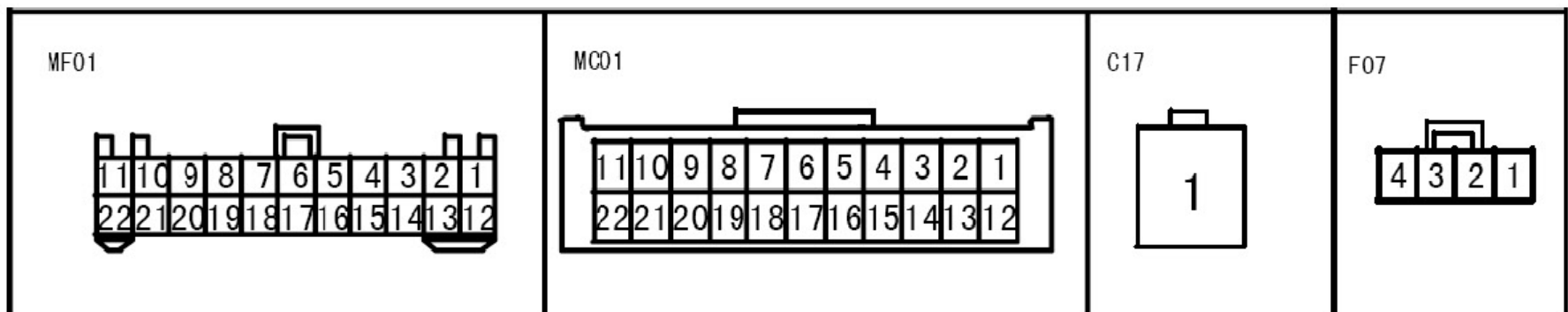
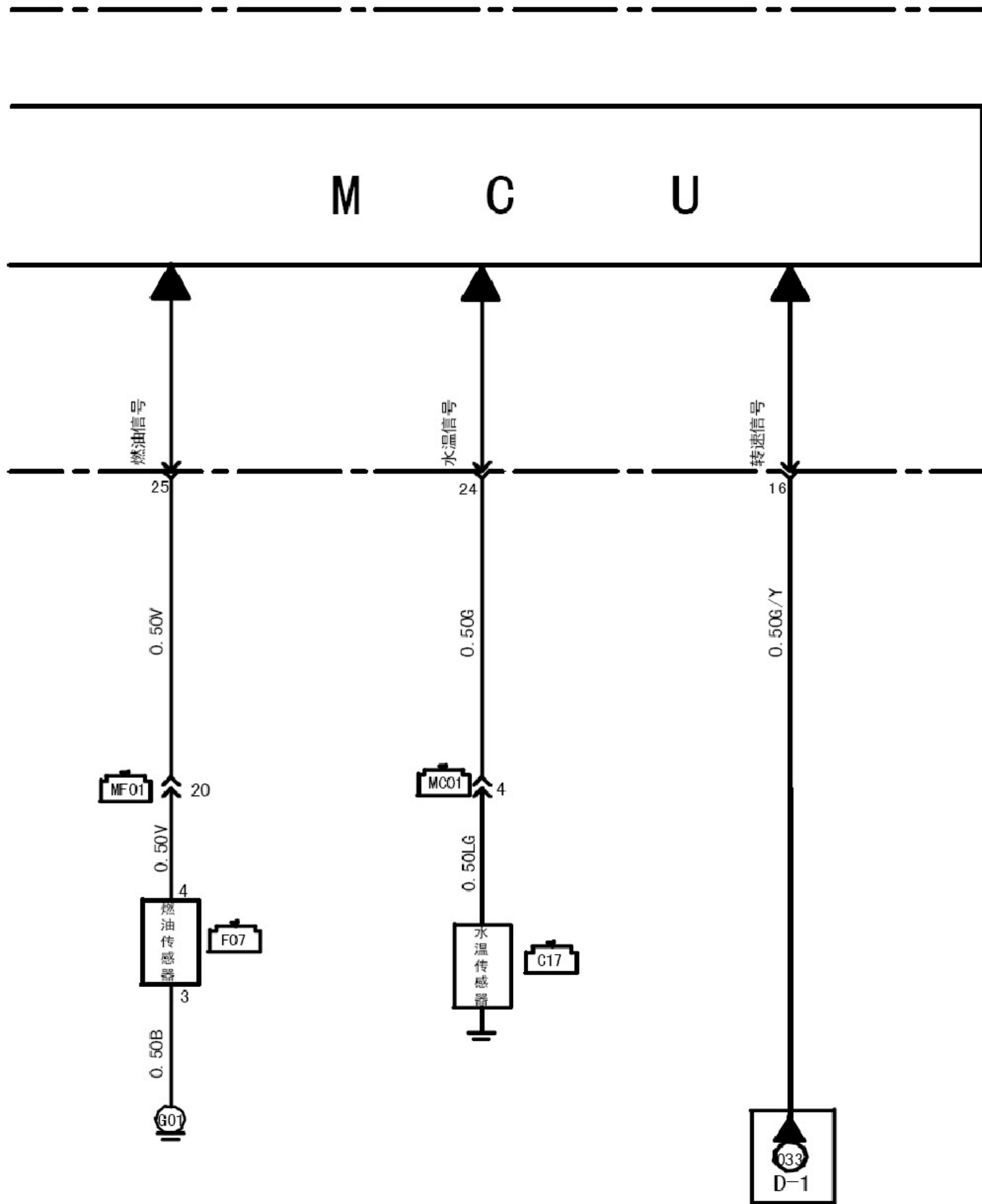

# 仪表系统-8

P-8

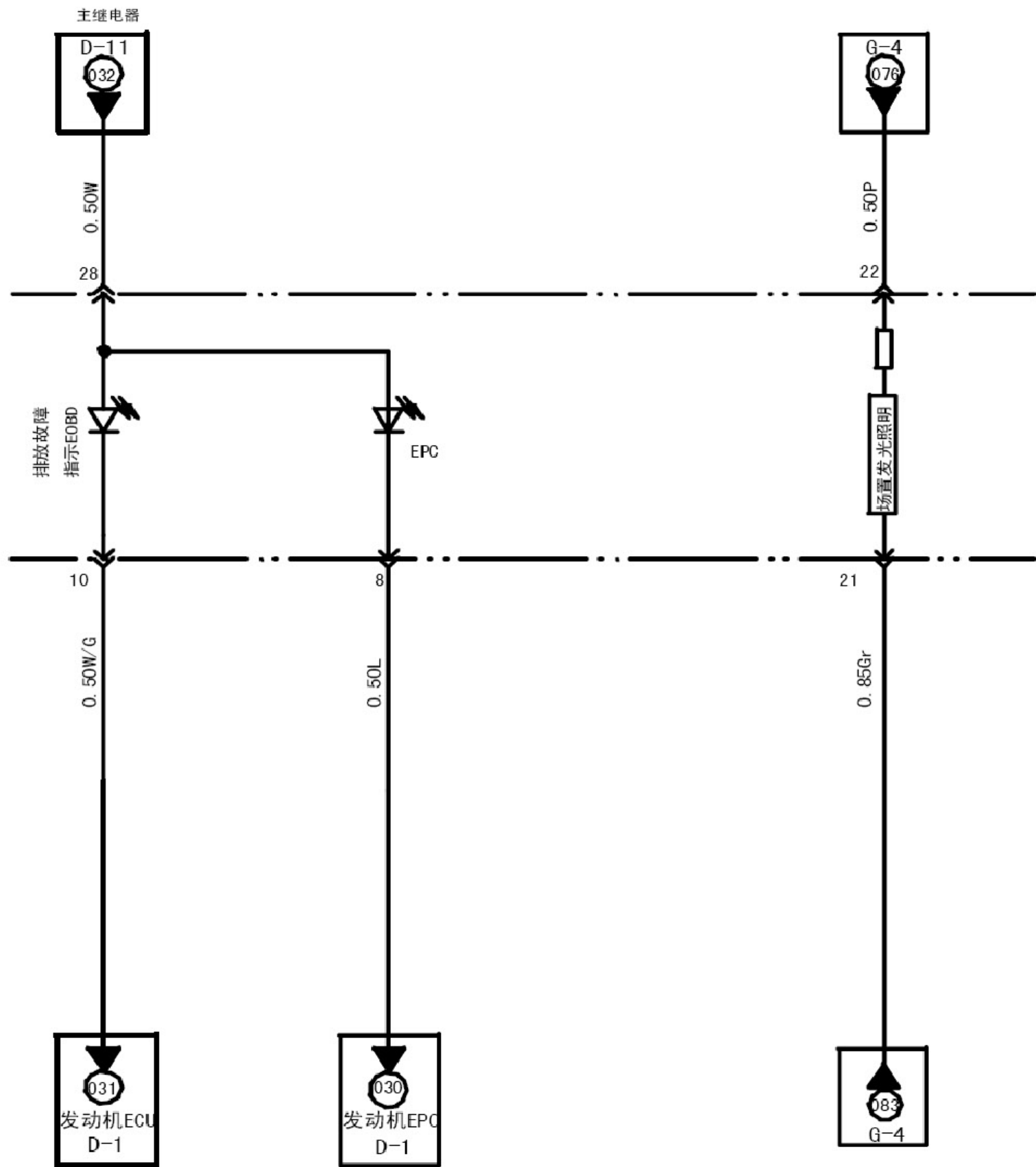

# 仪表系统-9

P-9

