

2.12 室内保险丝和继电器盒电路(左)

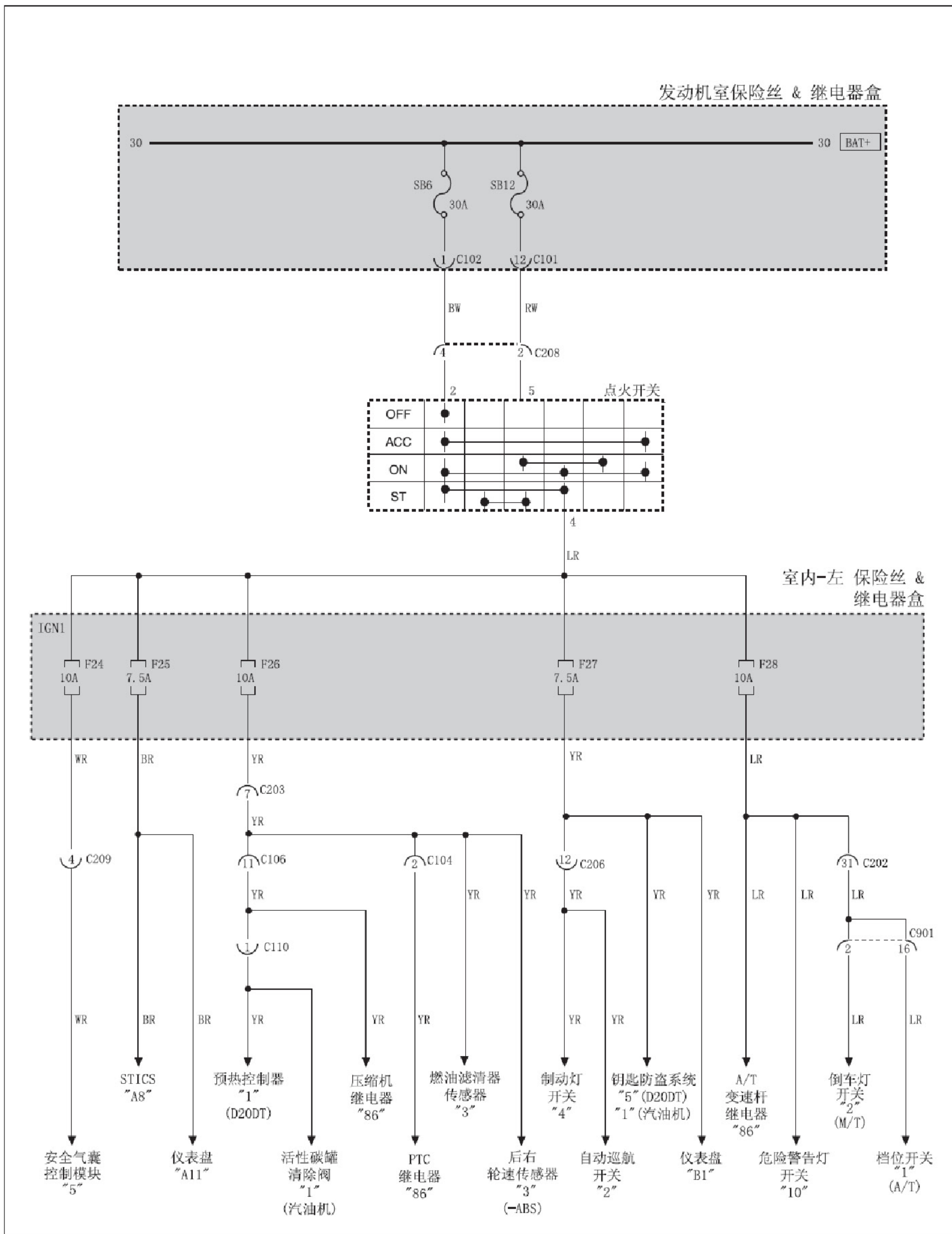

发动机室保险丝 & 继电器盒

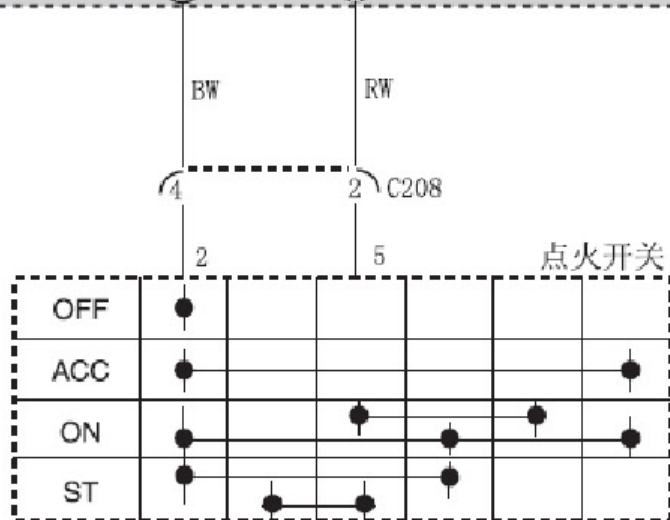
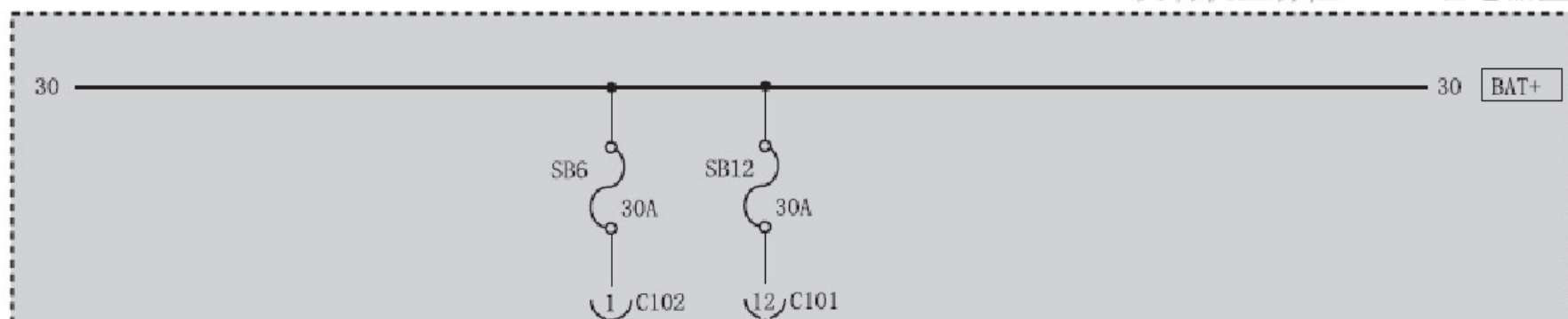

室内-左 保险丝 & 继电器盒

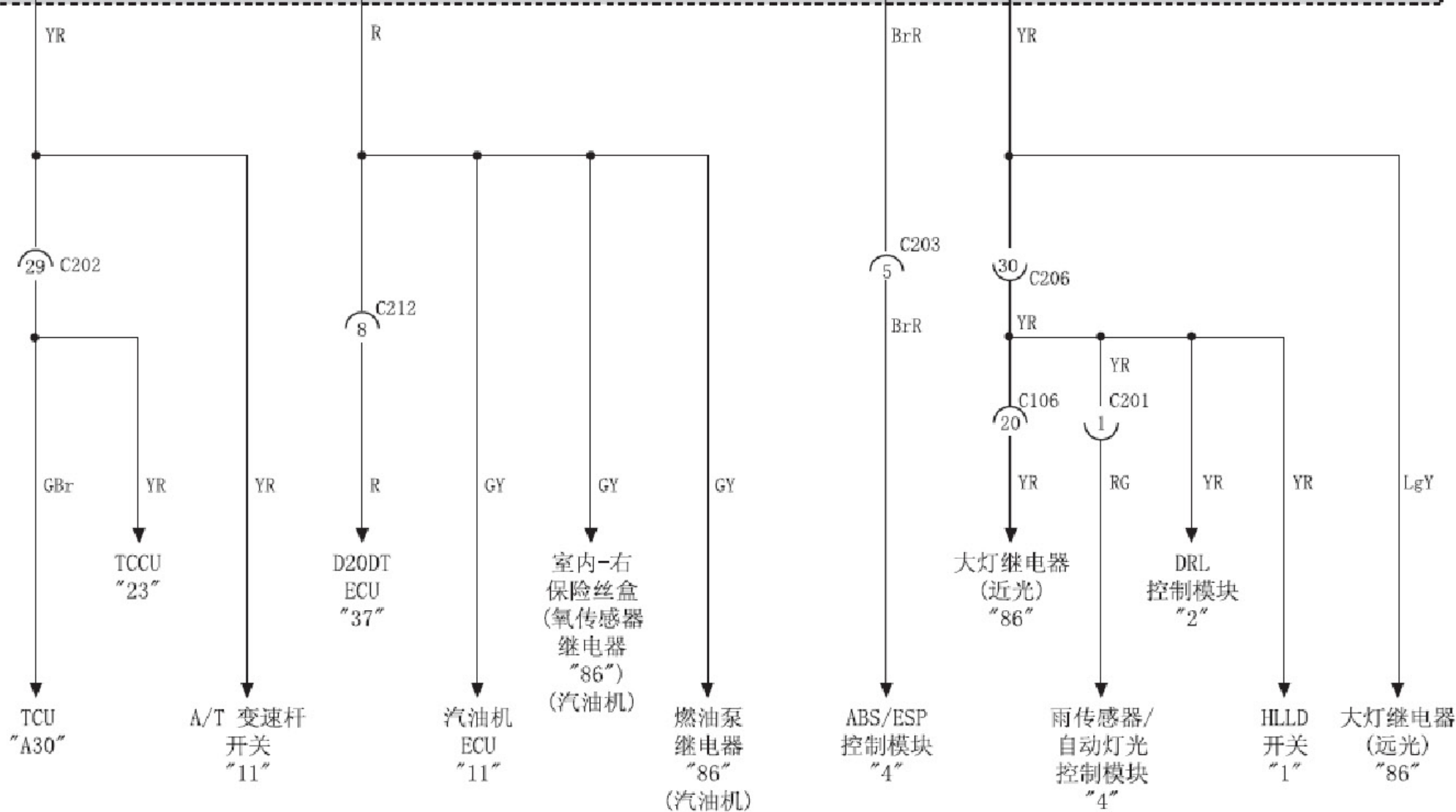
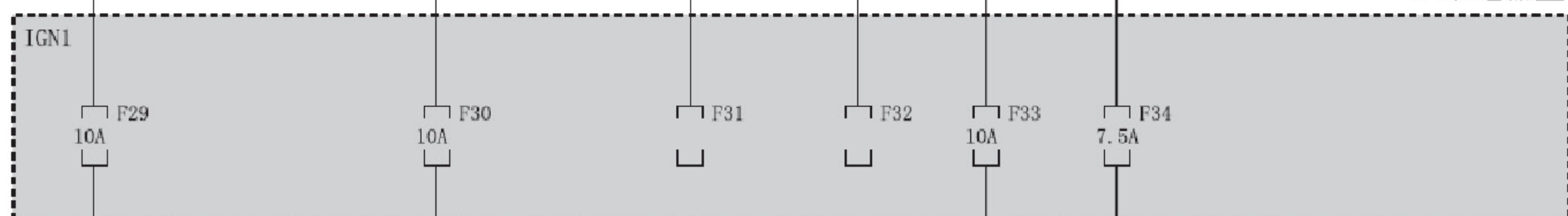

发动机室保险丝 & 继电器盒

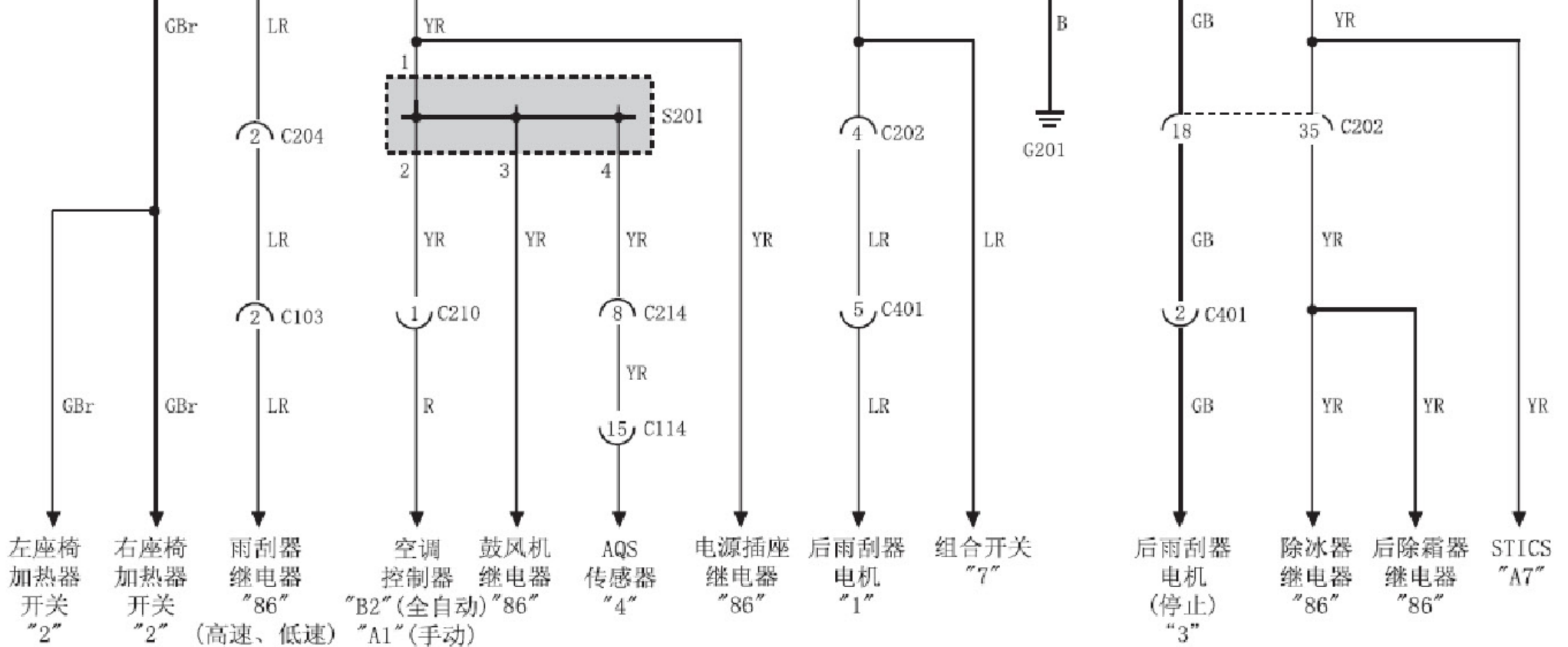
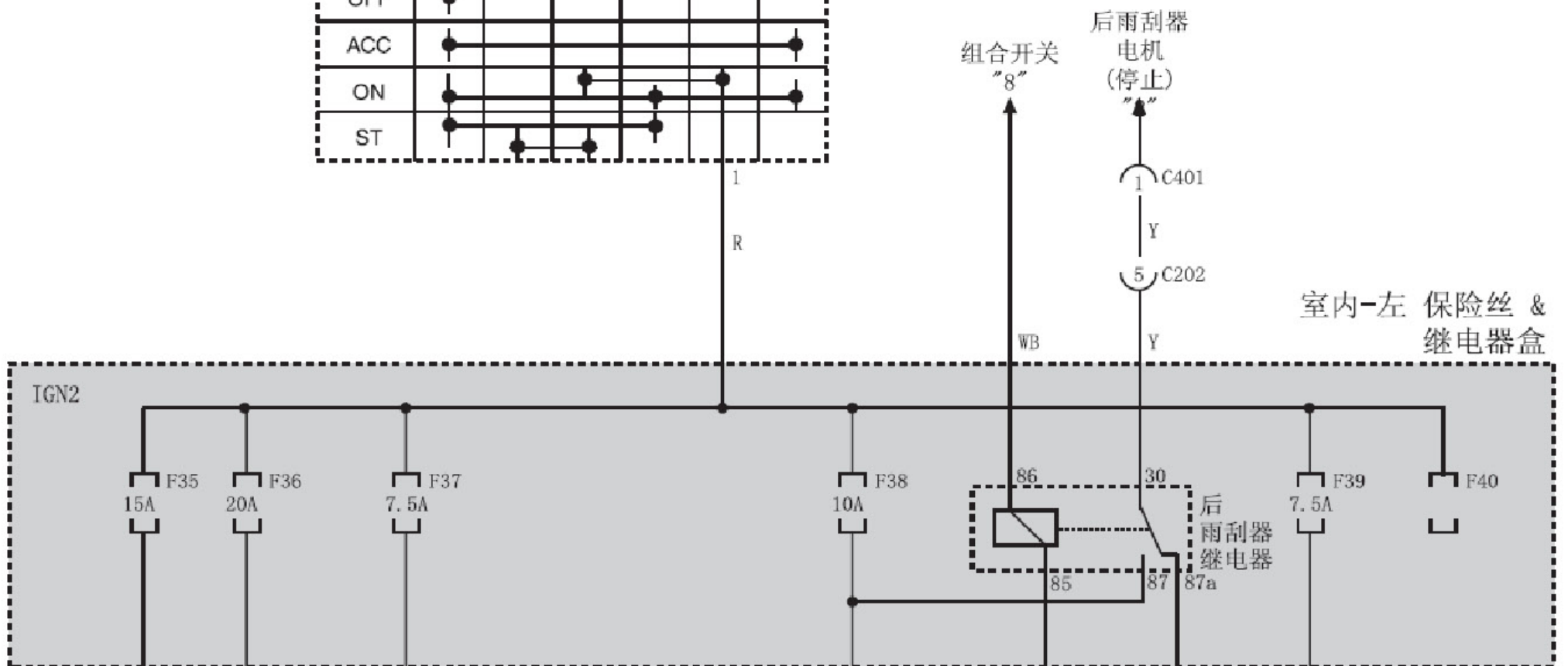
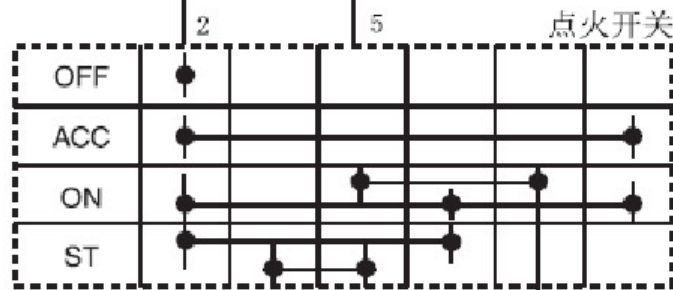

发动机室保险丝 & 继电器盒

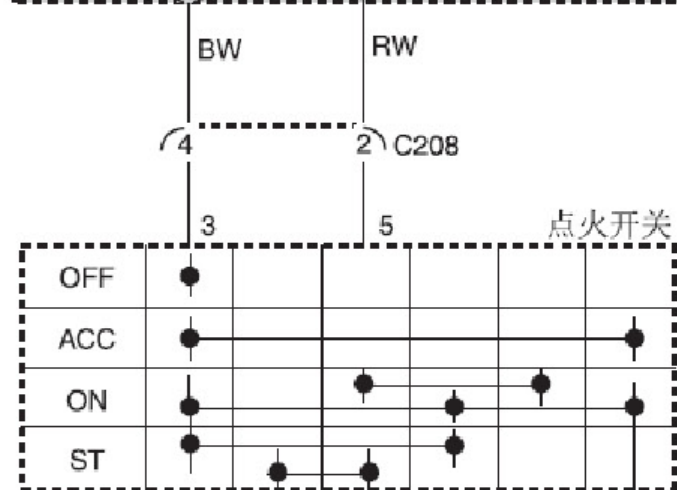
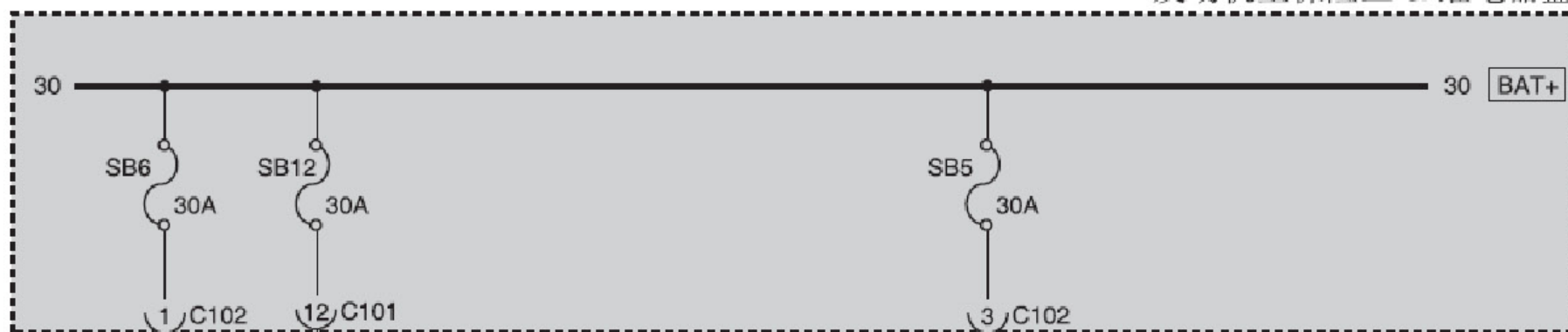

室内-左 保险丝 & 继电器盒

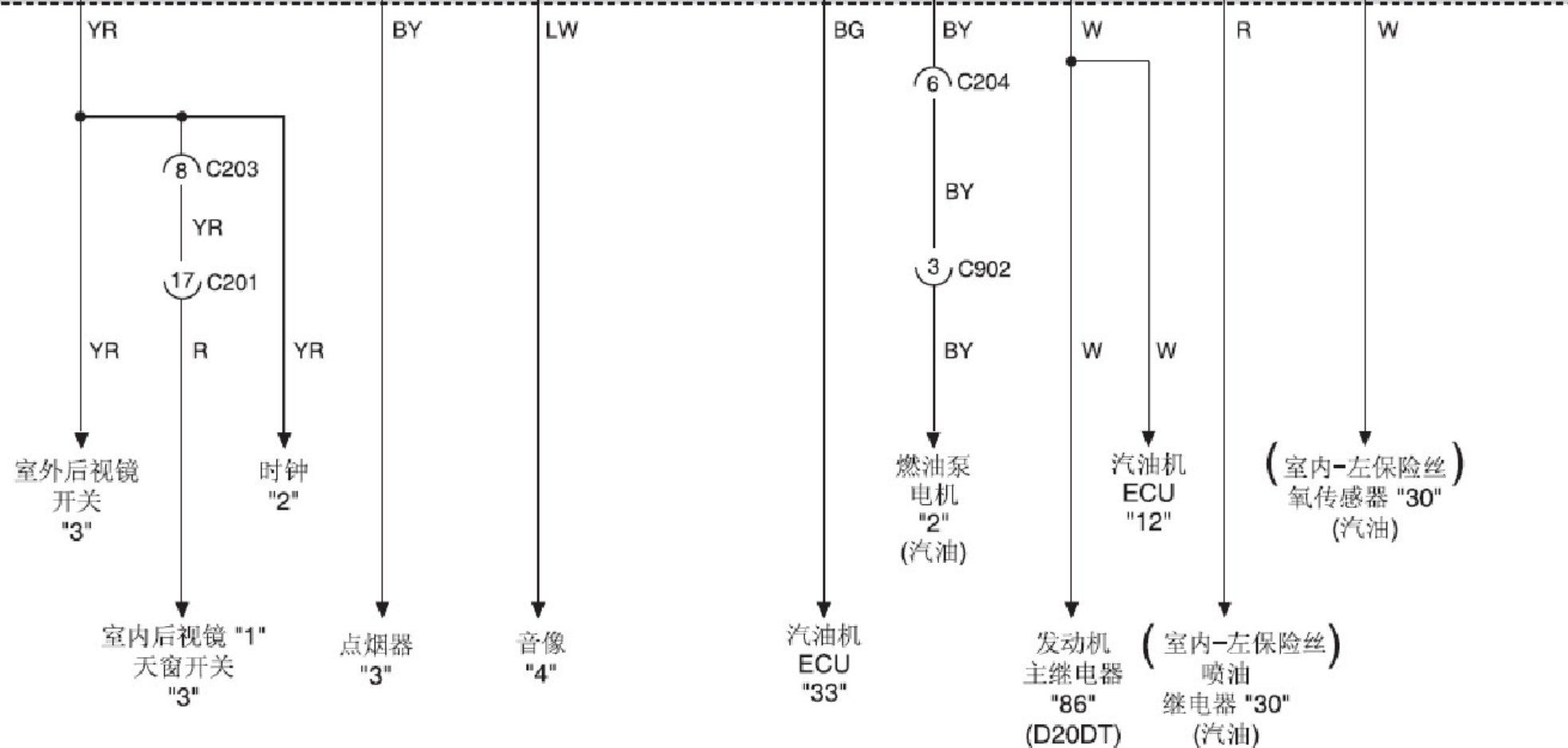
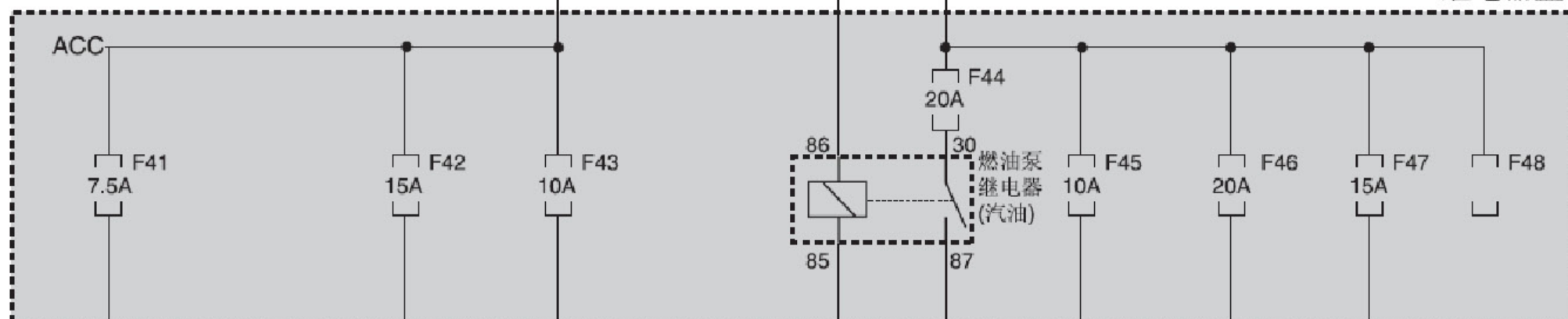

发动机室保险丝 & 继电器盒



室内-左 保险丝 & 继电器盒

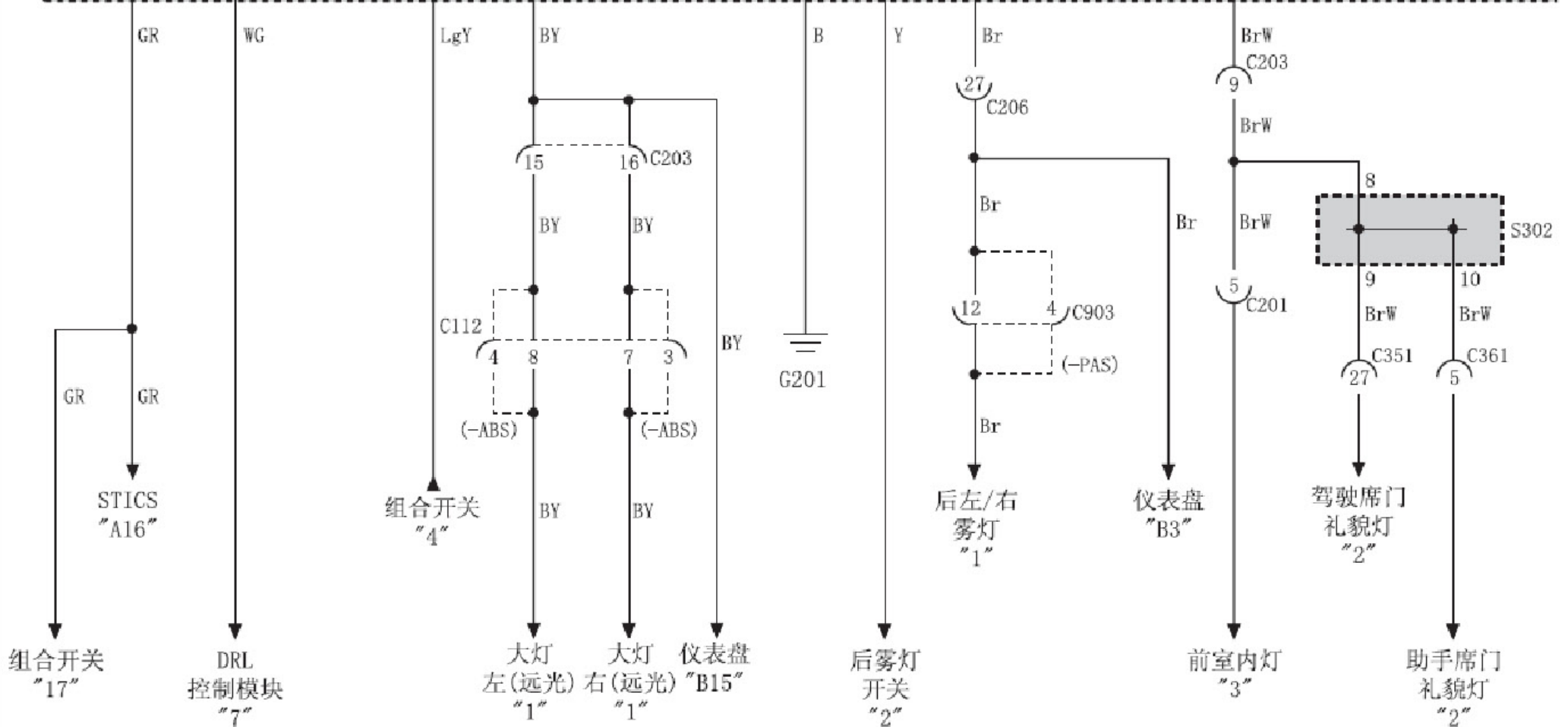
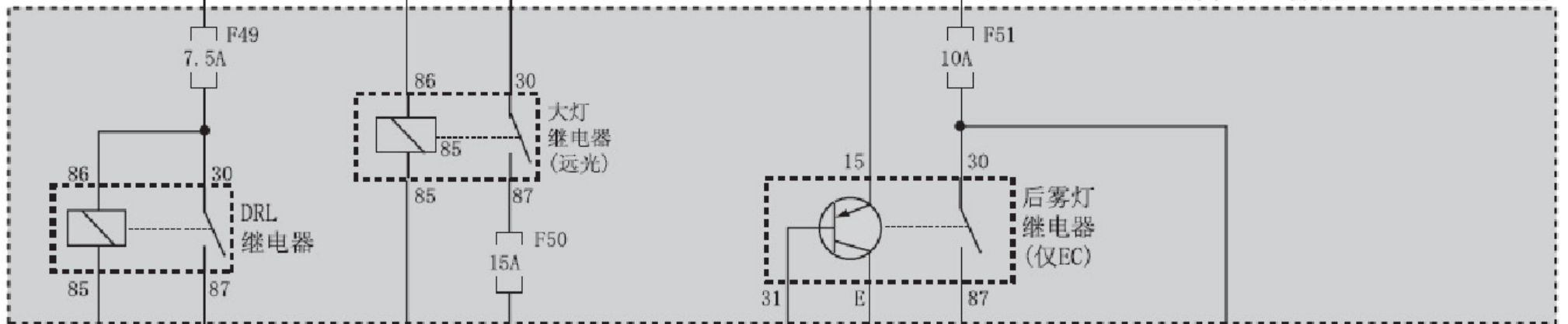

发动机室保险丝 & 继电器盒



室内-左 保险丝 & 继电器盒

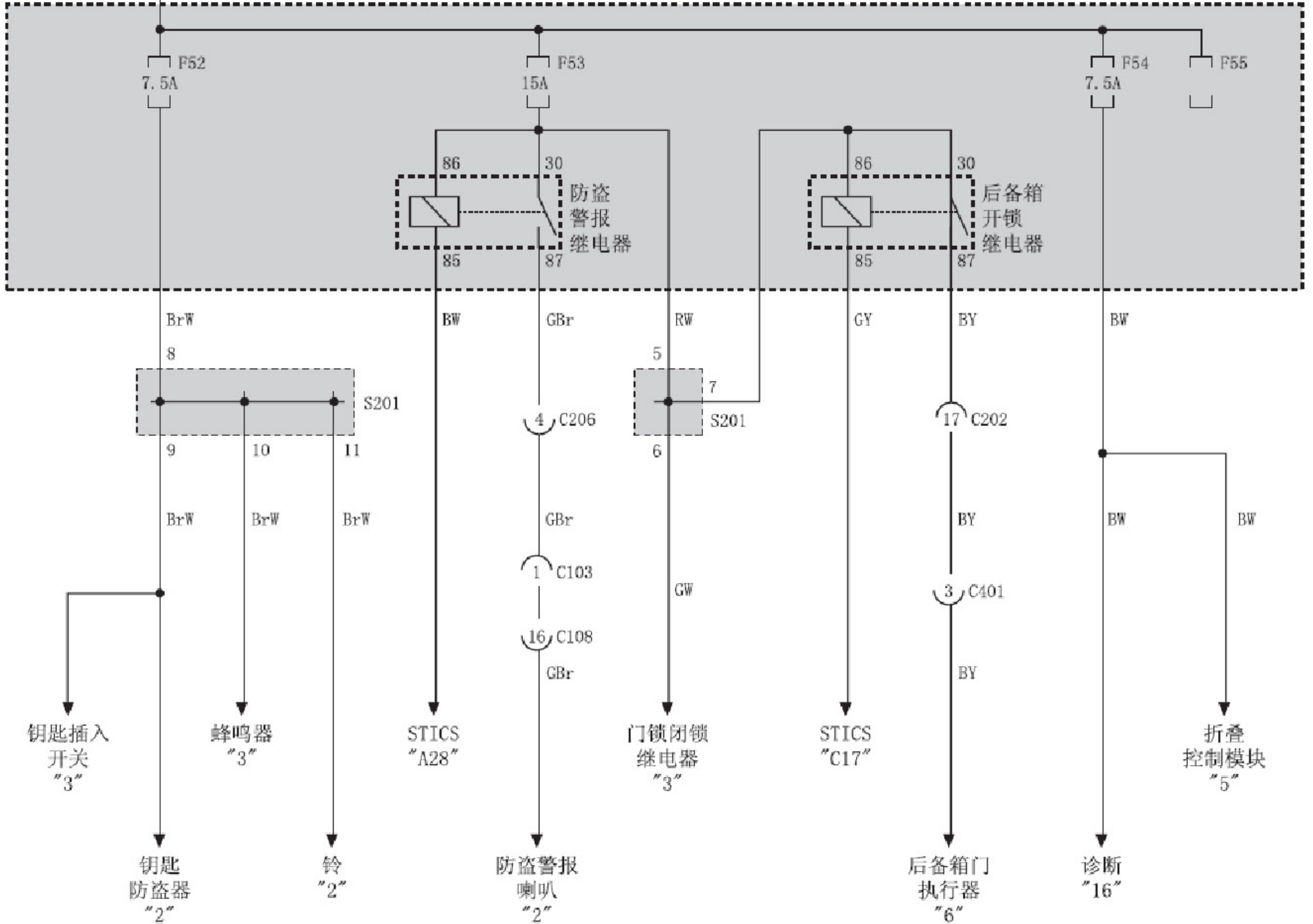

发动机室保险丝 & 继电器盒

