

2.11 电子系统匹配

仪表板下方

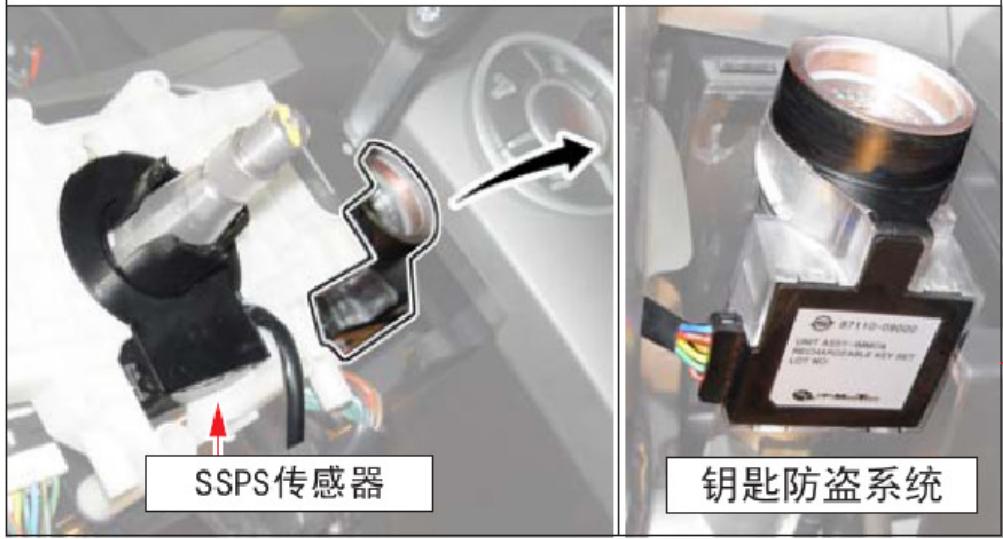

SSPS传感器 (D27DT) / 钥匙防盗系统



SSPS传感器

钥匙防盗系统

车门锁继电器

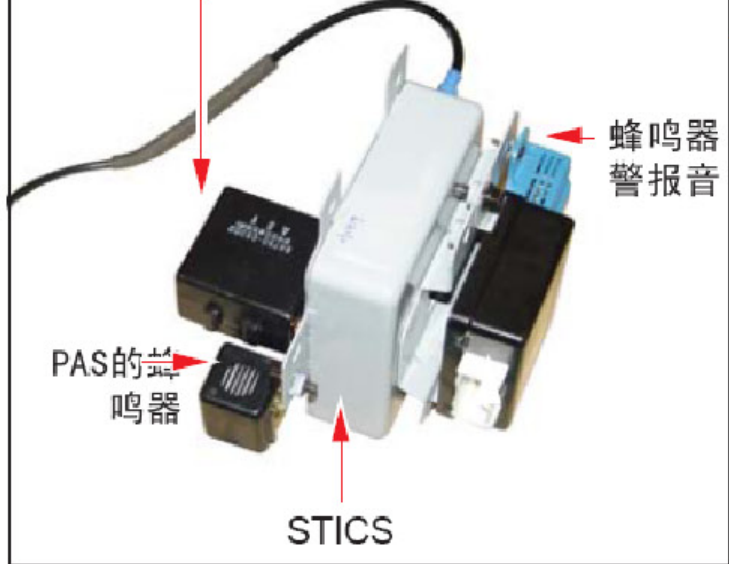

蜂鸣器
警报警

PAS的蜂
鸣器

STICS

窗帘式安全
气囊传感器

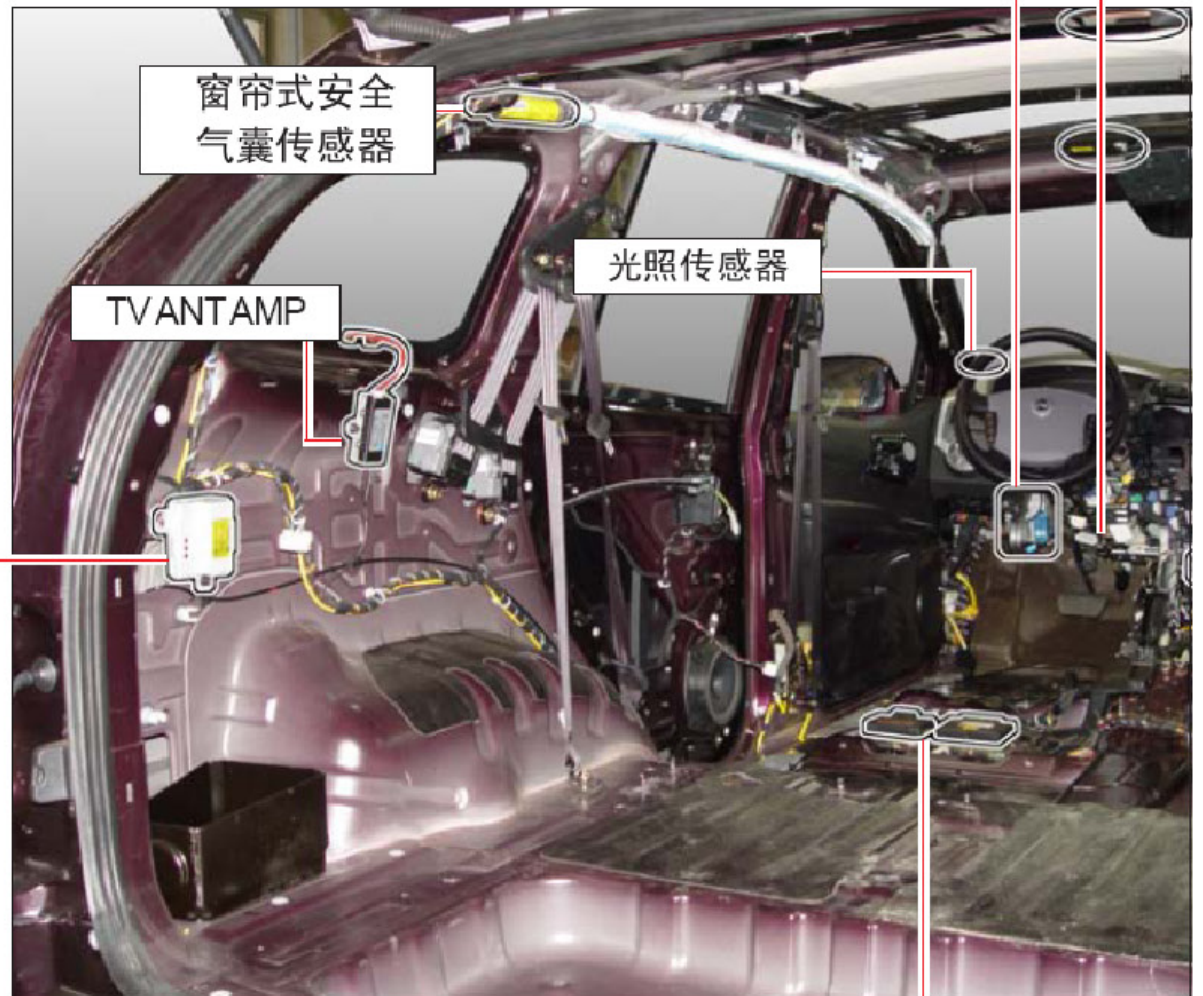

TVANTAMP

光照传感器

PAS单元



驾驶席座椅预备记忆



TCCU / TCU

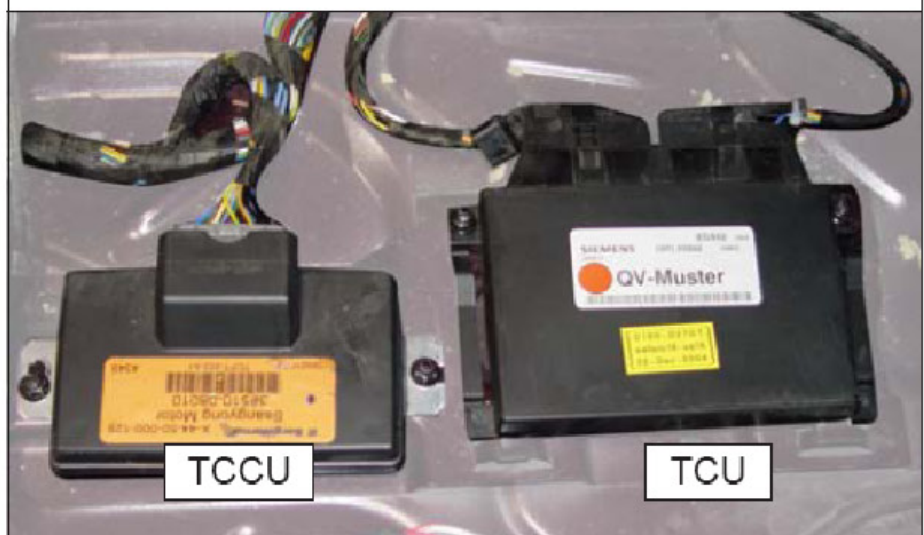

TCCU

TCU

雨检测单元（包括自动灯）和 ECM



传感器组



天窗单元和电机



天窗单元

天窗电机

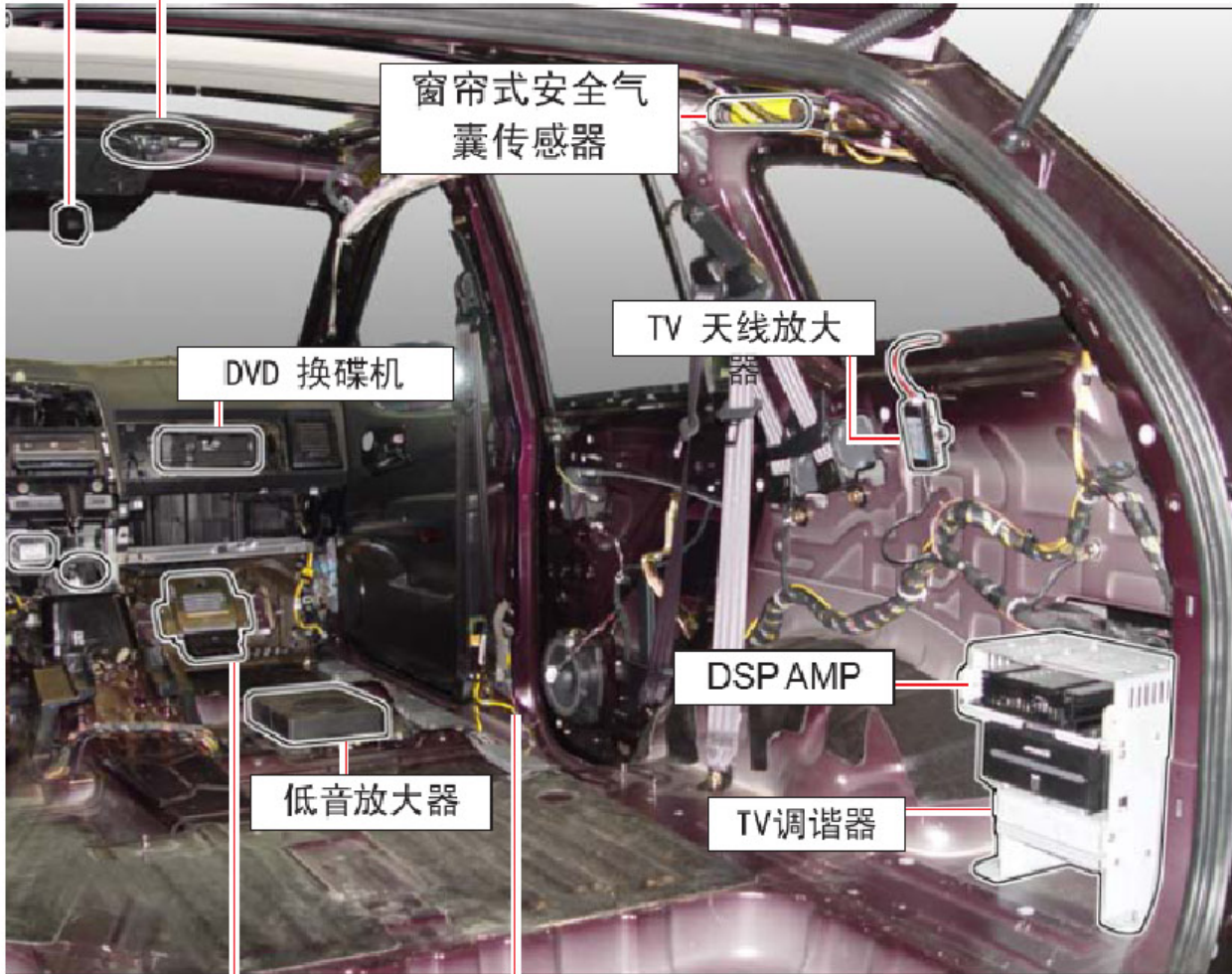

安全气囊ECU



窗帘式安全气囊传感器



发动机 ECU/SSPS单元

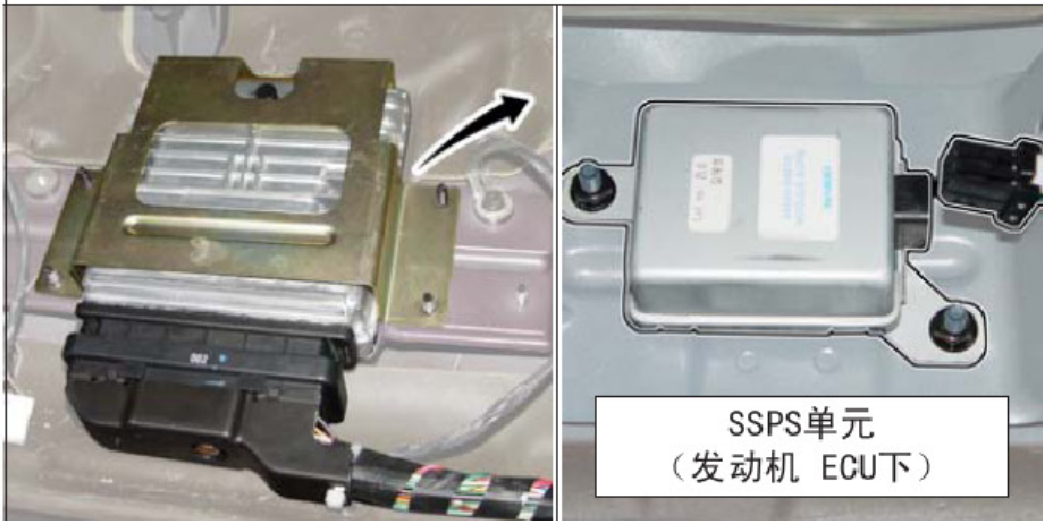

SSPS单元
(发动机 ECU下)

室内温度和湿度传感器



FFH (烧油加热器)



储液干燥器



喇叭



AQS传感器和FFH室外温度传感器

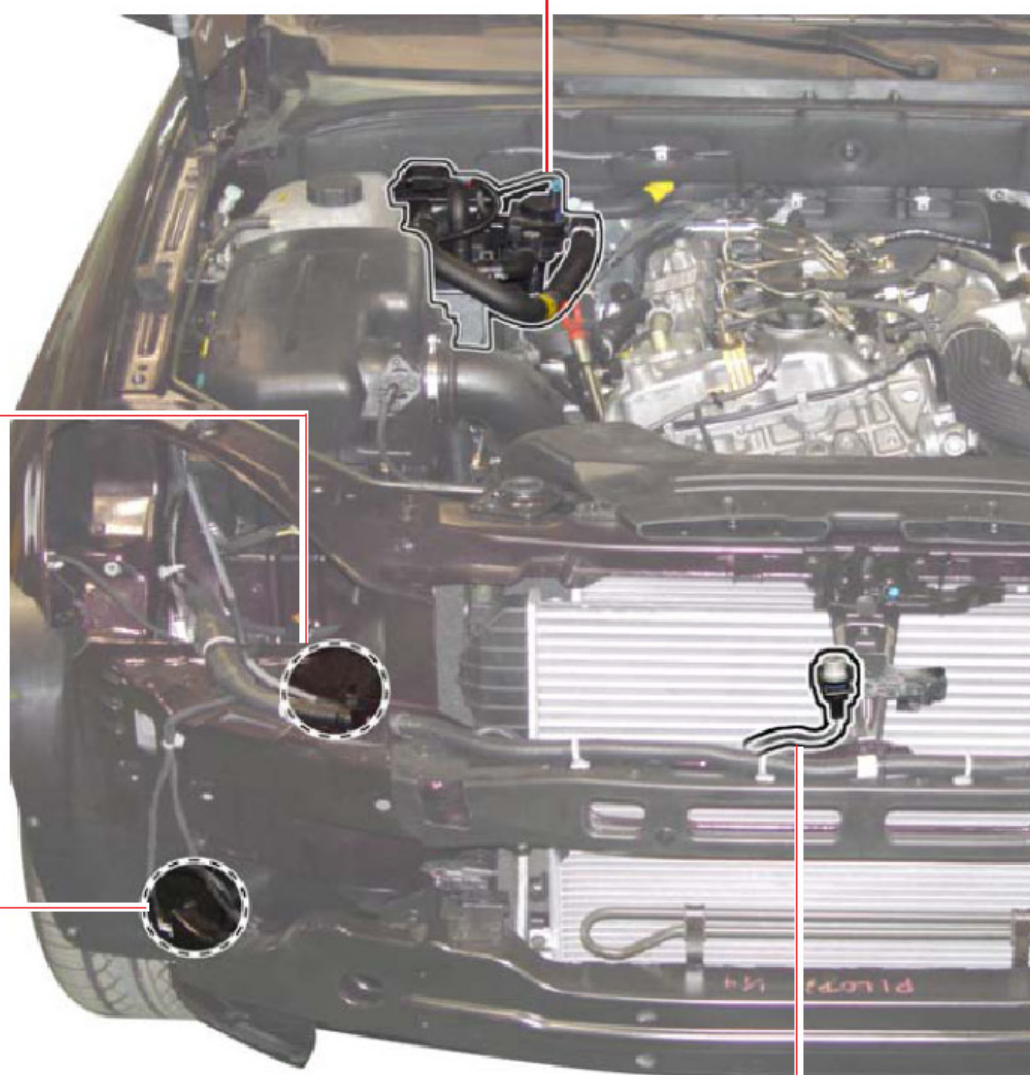

ESP 压力传感器/主, 副



ABS (ESP) HECU

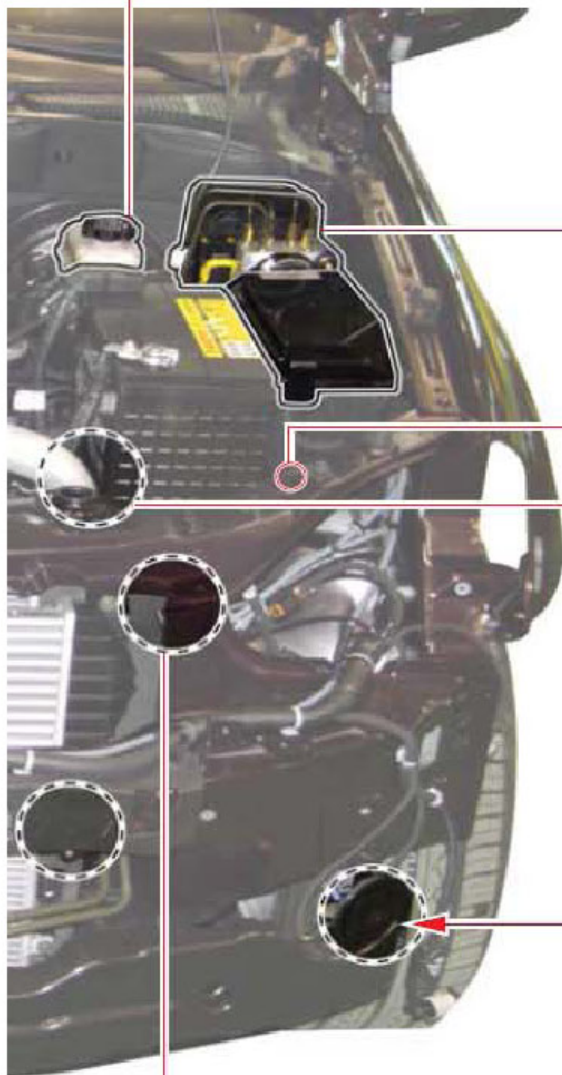

SW盒

喇叭 (左)

IWE真空电磁阀 (4WD)



(蓄电池托盘上)

防盗警报喇叭 (蓄电池下方)

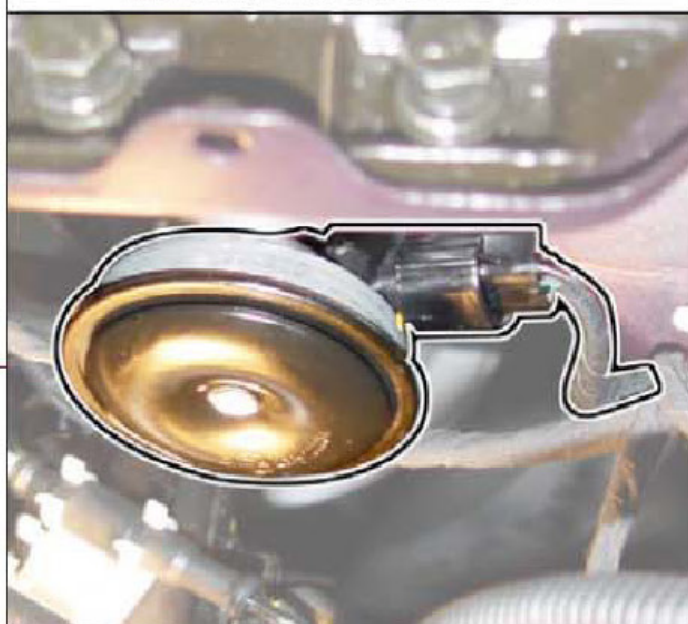

保险丝和继电器盒



方向盘上的遥控开关



室外后视镜调整开关上的边框总成

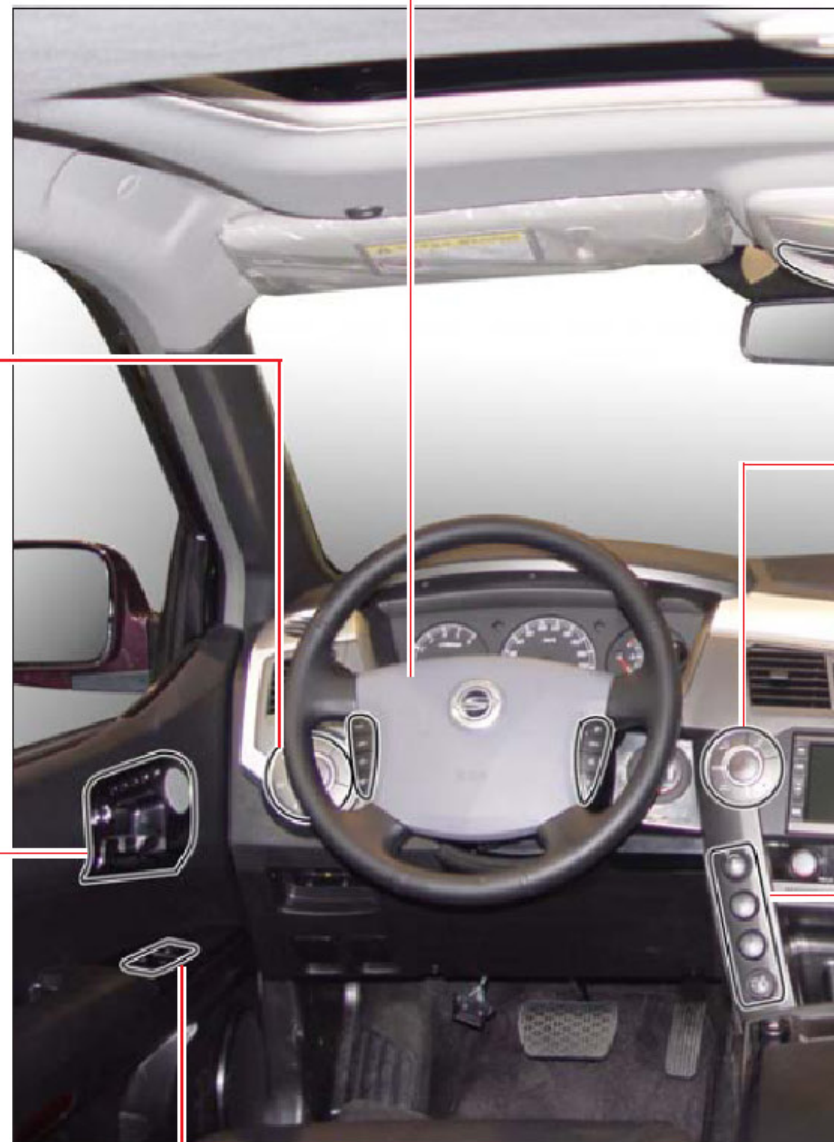

驾驶席主开关



电动门窗主开关



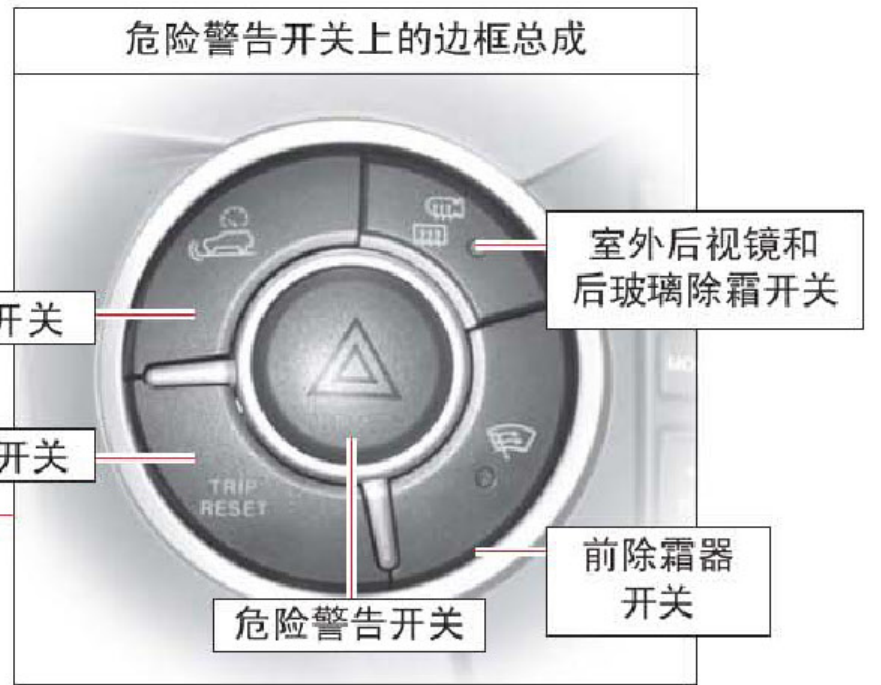

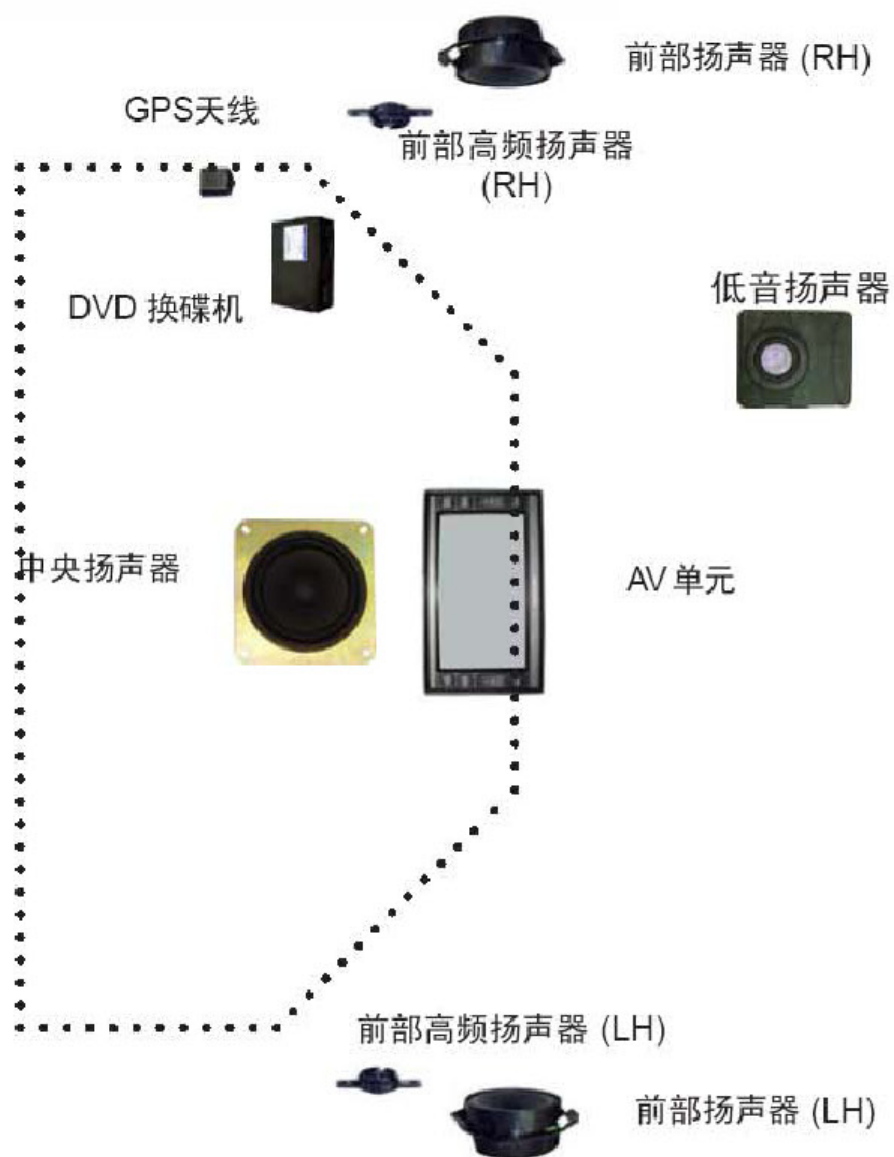
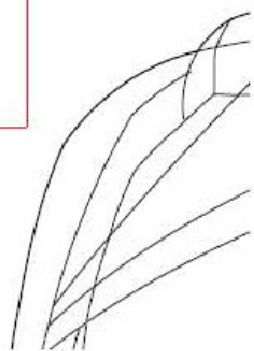

位置： 在杂物箱上侧



6pcs DVD 换碟机 (AV 系统)

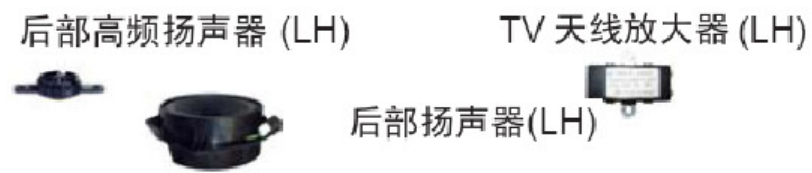

TV 天线放大器 (RH)

调谐器/放大器

Radio 天线放大器



Etc 自动单元

1. 6碟 CD+录音机+收音器

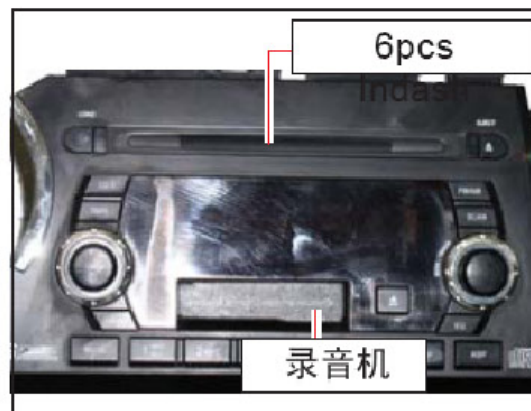

2. CD+收音机



类型	空调控制器
FATC	
手动 A/C	



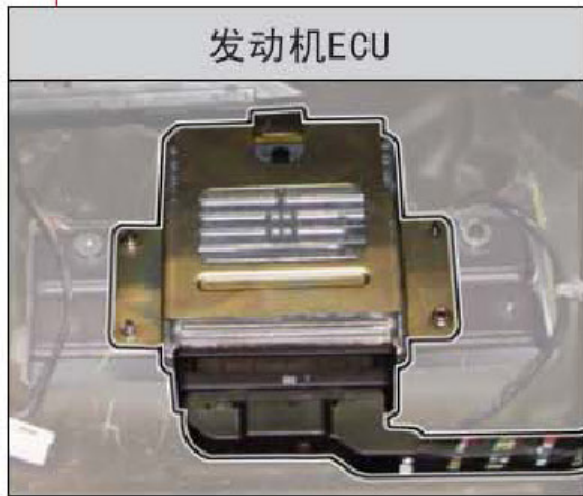
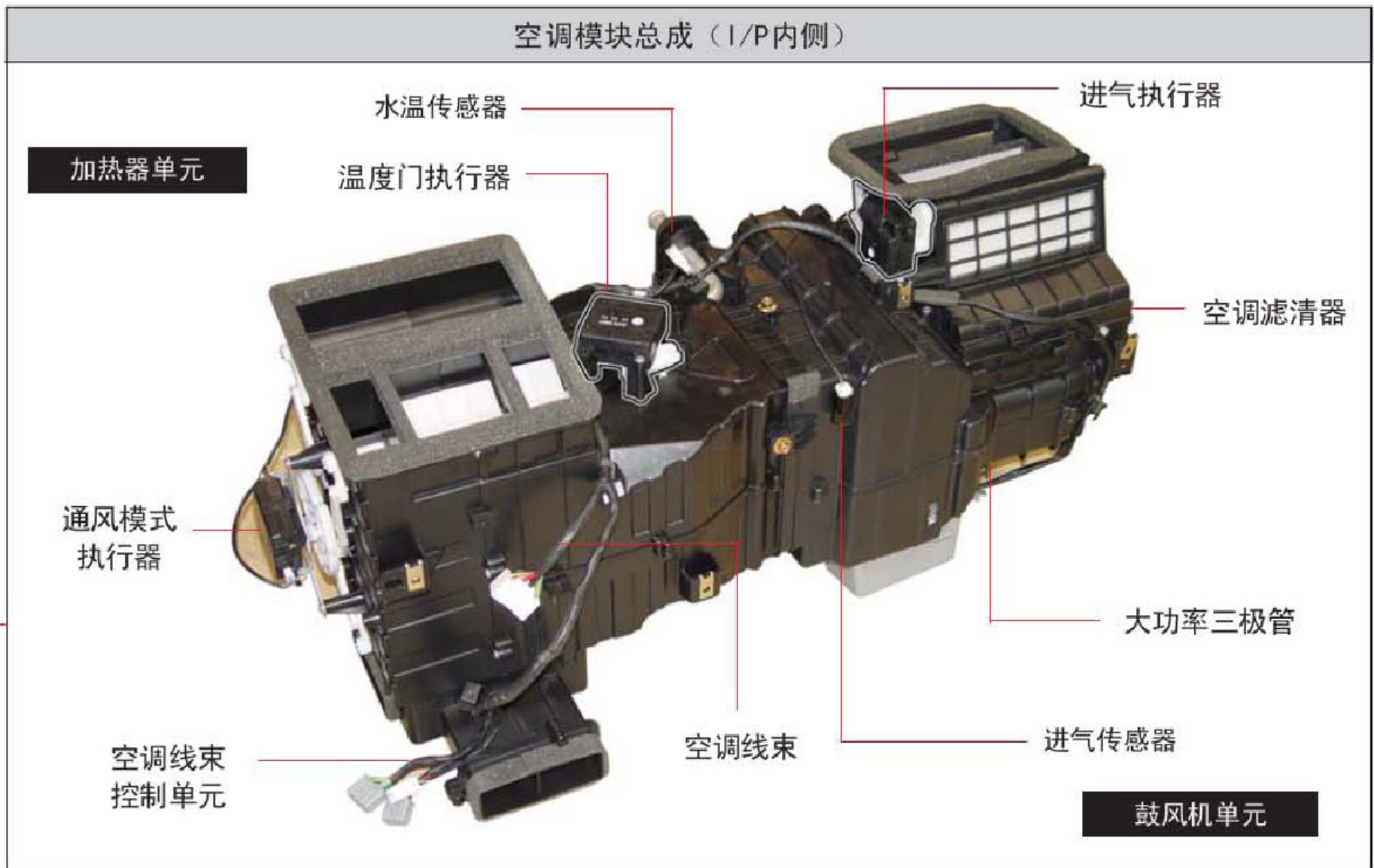



空调模块导线

