

2.26 指示灯和仪表

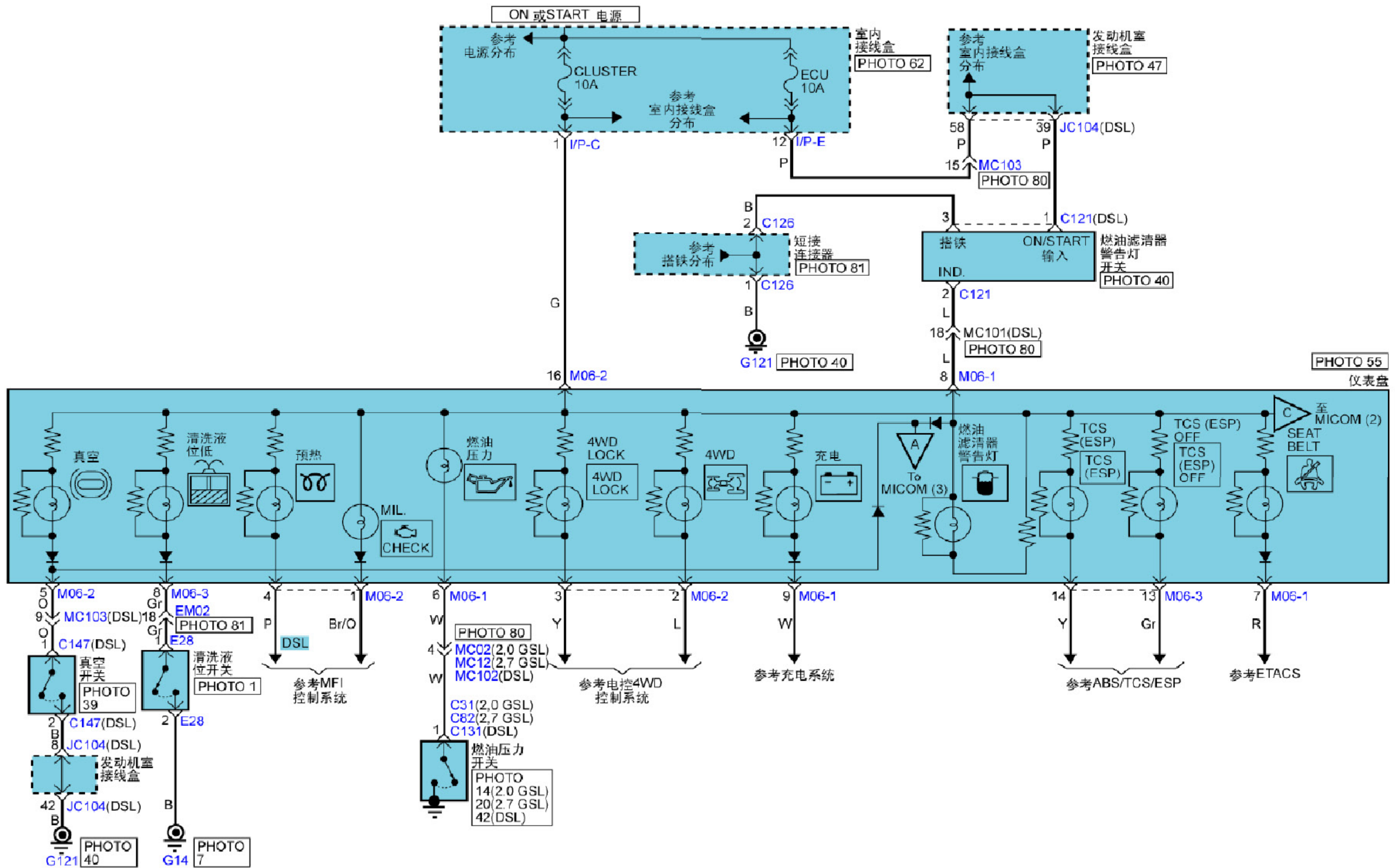

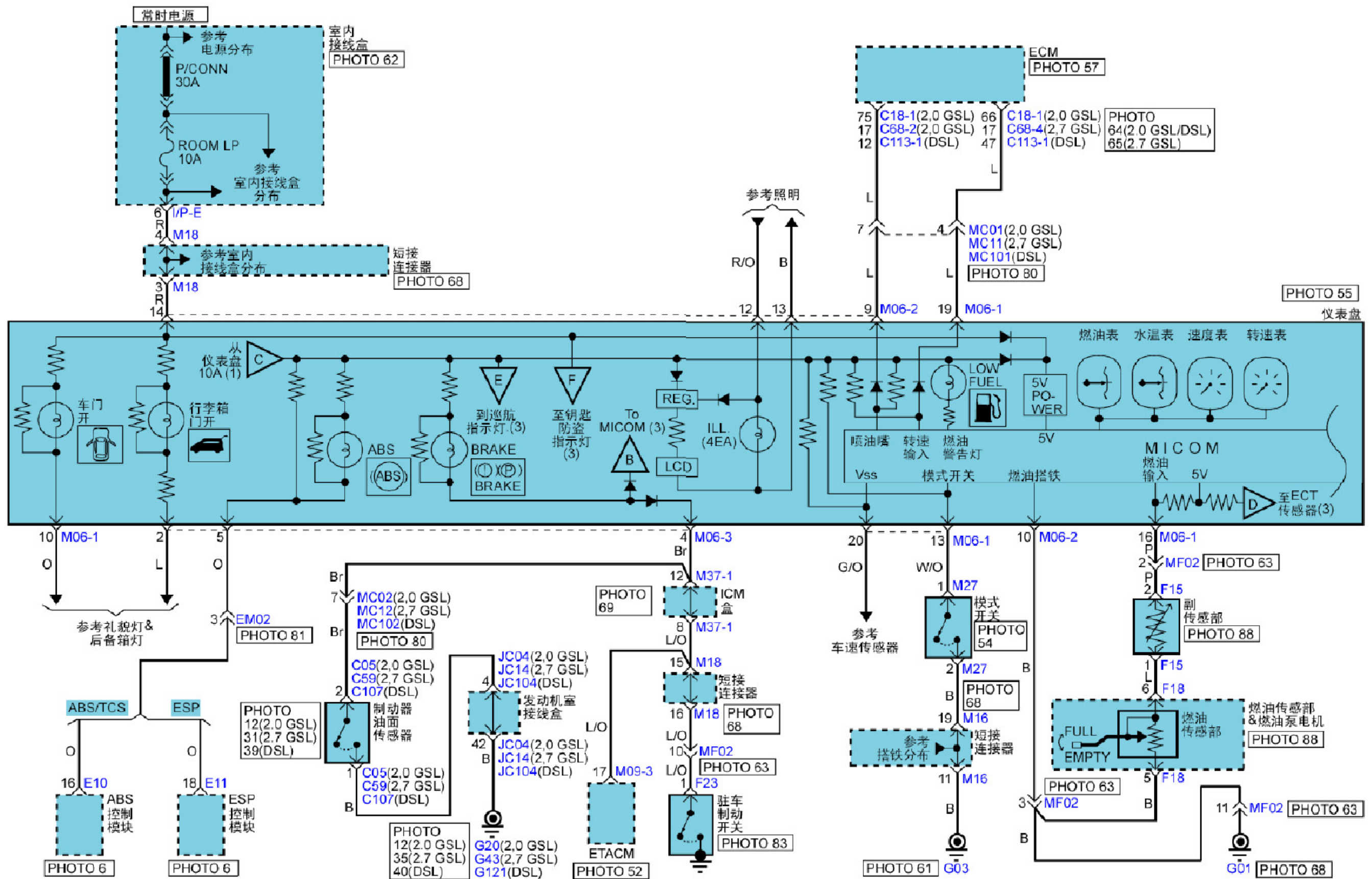

指示灯和仪表（续）

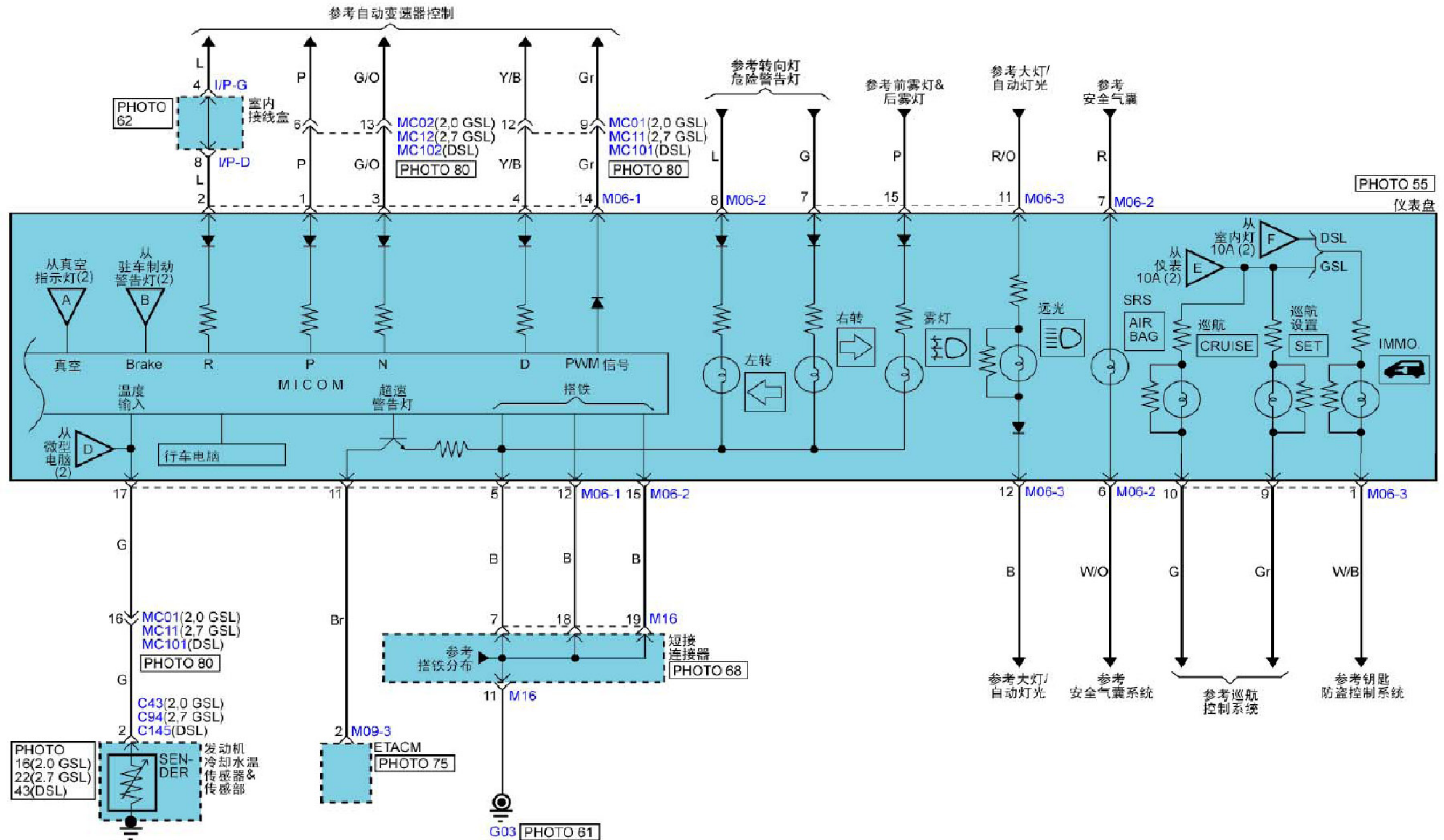

指示灯和仪表 (续)

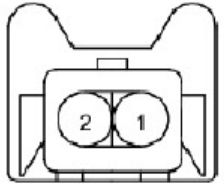
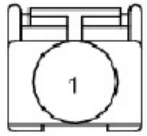
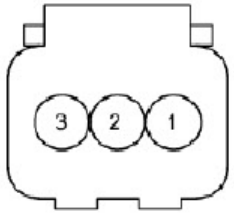

指示灯和仪表 (续)

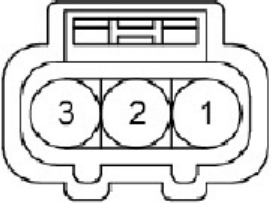
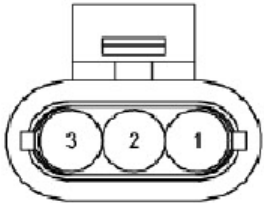
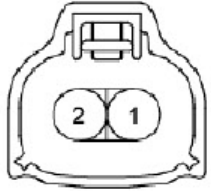
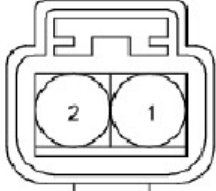
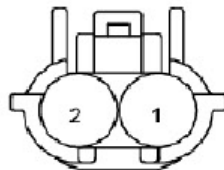
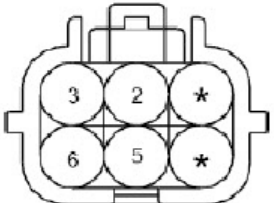
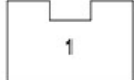
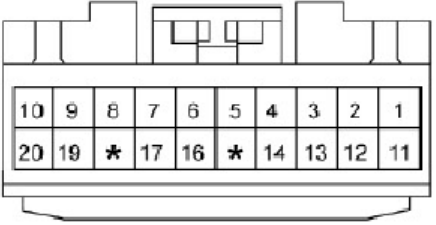
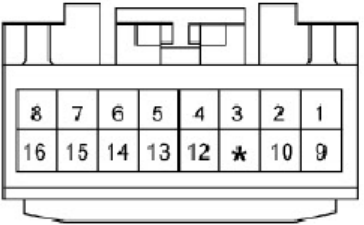
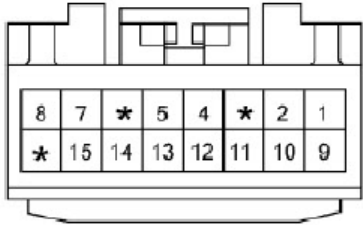
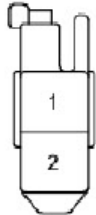
<p>C05/C59/C107</p>  <p>AMP_JPT_02F_B</p>	<p>C31</p>  <p>AMP_PLM2_01F_B</p>	<p>C43/C145</p>  <p>KUM_WTS_03F_B</p>	<p>C82/C131</p>  <p>KUM_NMWP_01F_B</p>
<p>C94</p>  <p>KUM_62Z_03F_B_WTS</p>	<p>C121</p>  <p>AMP_1.5WP_03F_W</p>	<p>C147</p>  <p>KET_090WP_02F_B</p>	<p>E28</p>  <p>KUM_NMWP_02F_B</p>
<p>F15</p>  <p>KET_SWP_02F_B</p>	<p>F18</p>  <p>KET_SWP_06F_B</p>	<p>F23</p>  <p>AMP_250DL_01F_B</p>	<p>M06-1</p>  <p>MLX_040III_20F_Gr</p>
<p>M06-2</p>  <p>MLX_040III_16F_Gr</p>	<p>M06-3</p>  <p>MLX_040III_16F_Gr</p>	<p>M27</p>  <p>KET_090II_02F_W_SPK</p>	<p>BLANK</p>