

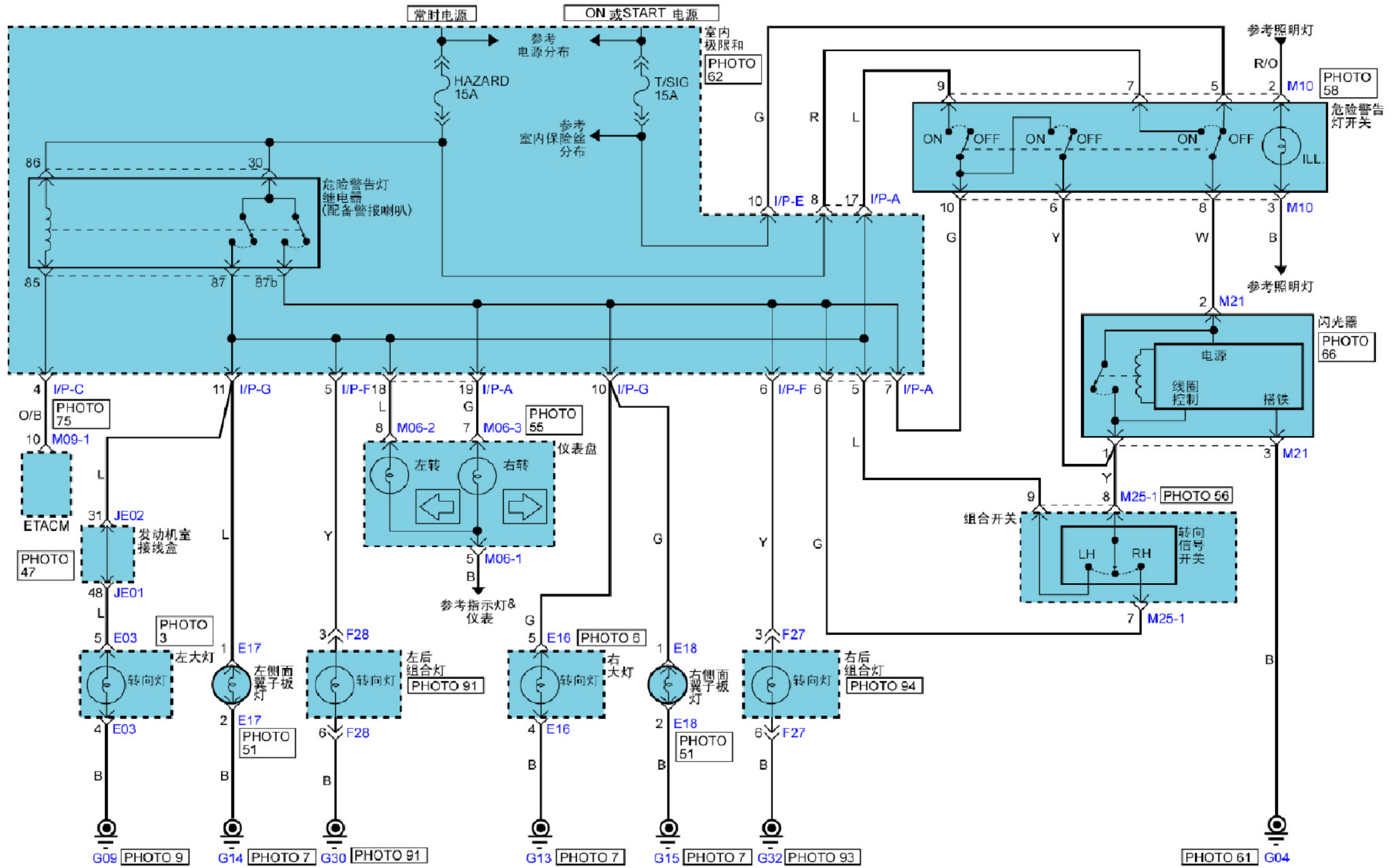
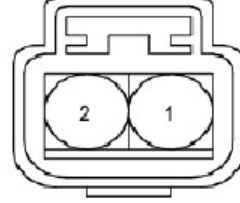

2.25 转向灯和危险警告灯

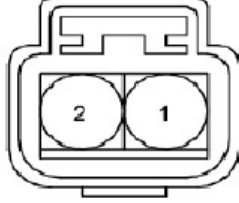
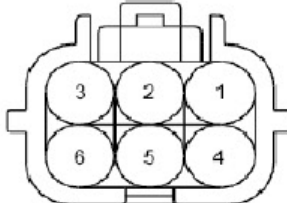
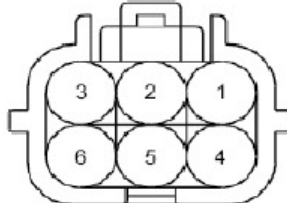
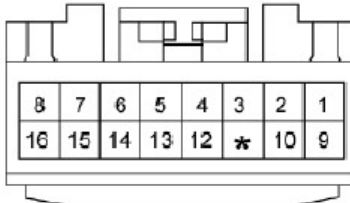
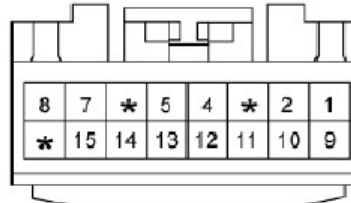
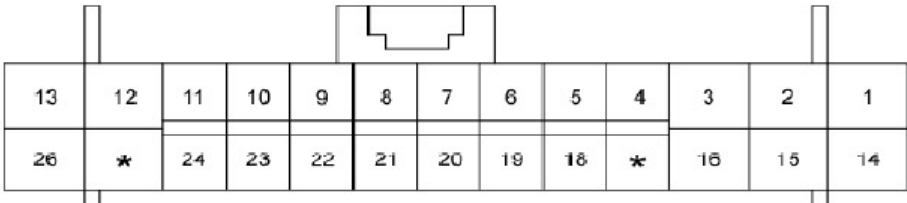
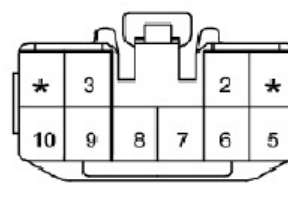
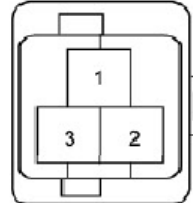
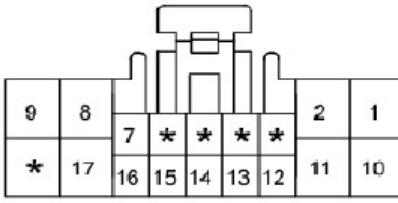

转向灯和危险警告灯 (续)

<p>E03</p>  <p>KUM_NMWP_06F_B</p>	<p>E16</p>  <p>KUM_NMWP_06F_B</p>	<p>E17</p>  <p>KUM_NMWP_02F_Gr</p>	<p>E18</p>  <p>KUM_NMWP_02F_Gr</p>
<p>F27</p>  <p>KET_SWP_06F_B</p>	<p>F28</p>  <p>KET_SWP_06F_B</p>	<p>M06-2</p>  <p>MLX_040III_16F_Gr</p>	<p>M06-3</p>  <p>MLX_040III_16F_Gr</p>
<p>M09-1</p>  <p>AMP_0407_26F_W_HD</p>		<p>M10</p>  <p>KET_090II_10F_W</p>	<p>M21</p>  <p>AMP_250_03F_B_RLY</p>
<p>M25-1</p>  <p>KET_0509_18F_W</p>	<p>BLANK</p>	<p>BLANK</p>	<p>BLANK</p>