

### 2.6 MFI控制系统

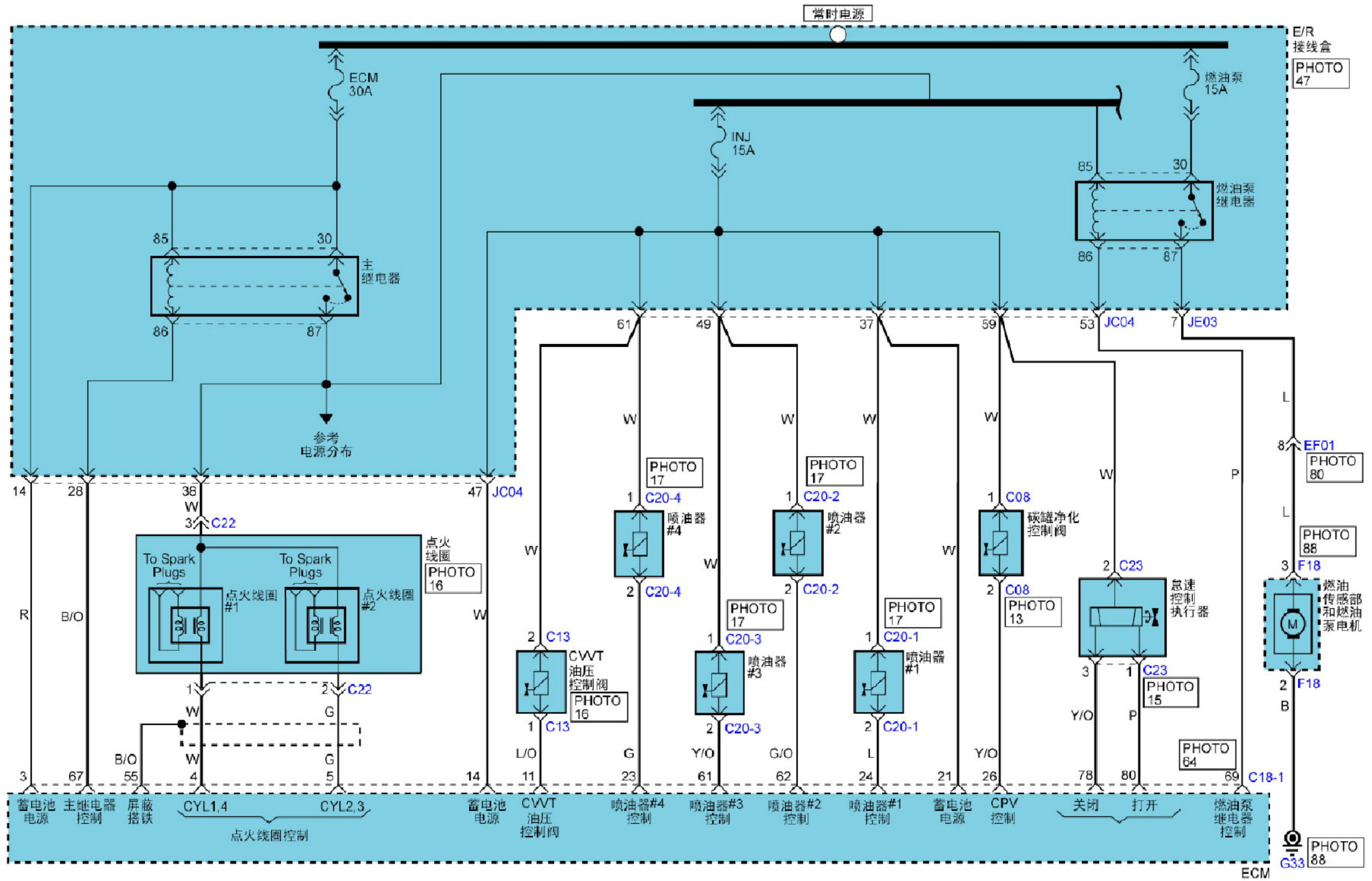

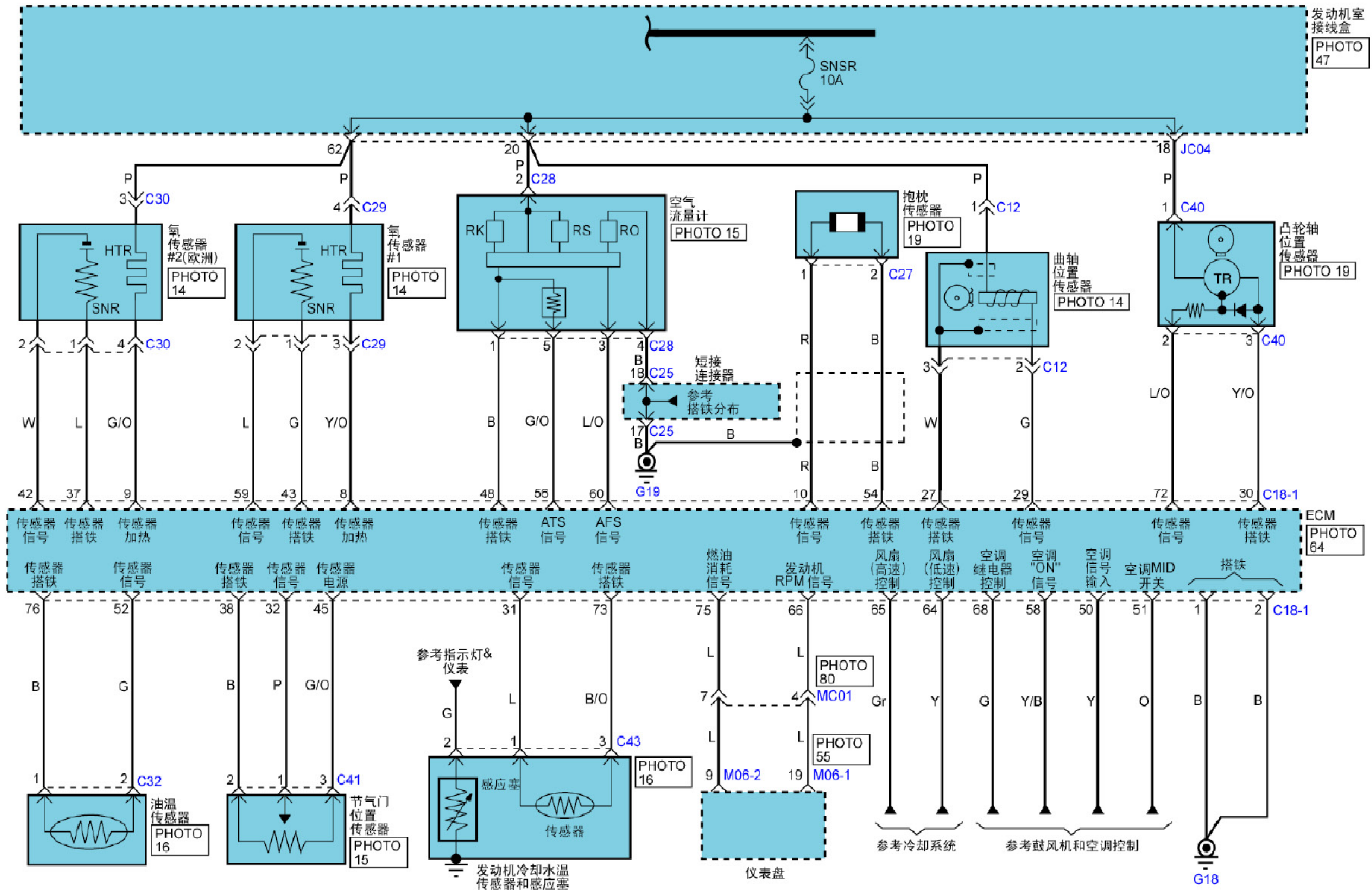





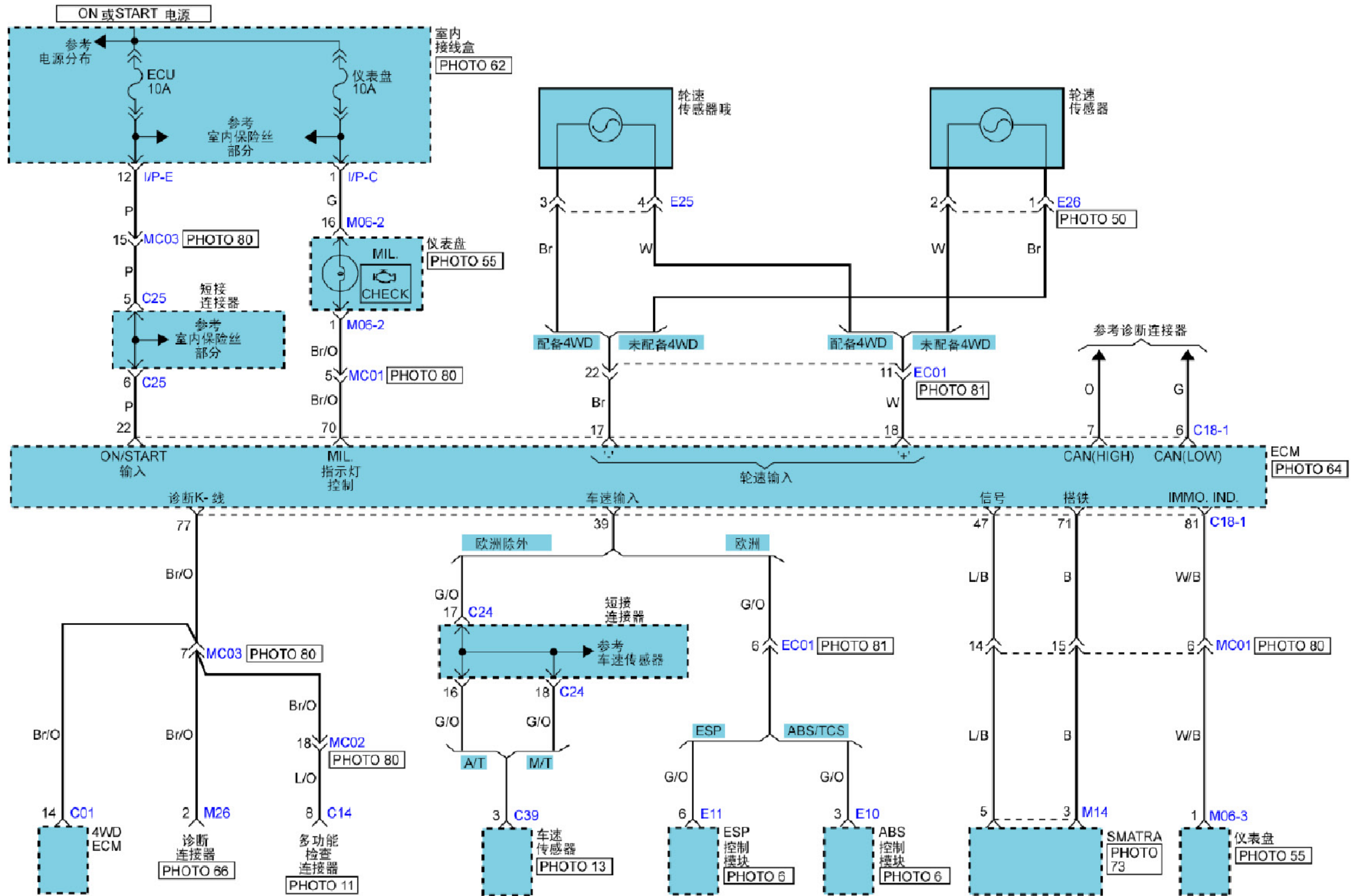

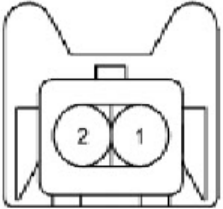
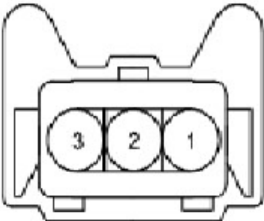

MFI控制系统 (续)

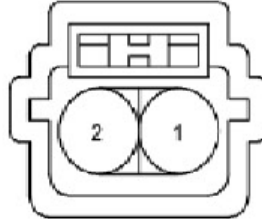

MFI控制系统 (续)

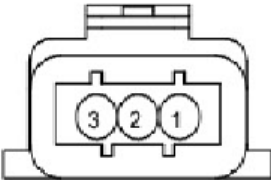
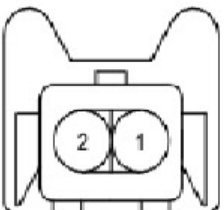
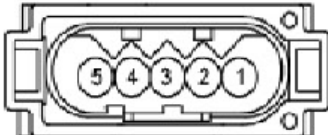

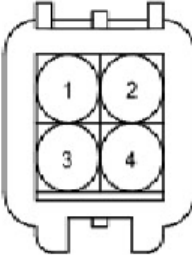
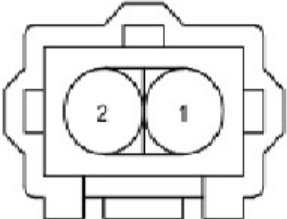
MFI控制系统 (续)

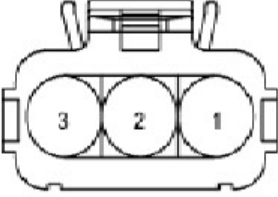
<p style="text-align: center;"><b>C08</b></p>  <p style="text-align: center;">AMP_JPT_02F_B</p>	<p style="text-align: center;"><b>C12</b></p>  <p style="text-align: center;">AMP_JPT_03F_GR_R1</p>	<p style="text-align: center;"><b>C13</b></p>  <p style="text-align: center;">KET_090WP_02F_B_L</p>	<p style="text-align: center;">BLANK</p>																																																																																		
<p style="text-align: center;"><b>C18-1</b></p> <table border="1" style="width: 100%; text-align: center;"> <tr> <td>6</td><td>7</td><td>8</td><td>9</td><td>10</td><td>11</td><td>*</td><td>*</td><td>14</td><td>*</td><td>*</td><td>17</td><td>18</td><td>*</td><td>*</td><td>21</td><td>22</td><td>23</td><td>24</td><td>5</td><td>4</td> </tr> <tr> <td>*</td><td>26</td><td>27</td><td>*</td><td>29</td><td>30</td><td>31</td><td>32</td><td>*</td><td>*</td><td>*</td><td>*</td><td>37</td><td>38</td><td>39</td><td>*</td><td>*</td><td>42</td><td>43</td><td colspan="2" rowspan="3">3</td> </tr> <tr> <td>*</td><td>45</td><td>*</td><td>47</td><td>48</td><td>*</td><td>50</td><td>51</td><td>52</td><td>*</td><td>54</td><td>55</td><td>56</td><td>*</td><td>58</td><td>59</td><td>60</td><td>61</td><td>62</td> </tr> <tr> <td>*</td><td>64</td><td>65</td><td>66</td><td>67</td><td>68</td><td>69</td><td>70</td><td>71</td><td>72</td><td>73</td><td>*</td><td>75</td><td>76</td><td>77</td><td>78</td><td>*</td><td>80</td><td>81</td><td>2</td><td>1</td> </tr> </table> <p style="text-align: center;">KET_ECU_B1F</p>		6	7	8	9	10	11	*	*	14	*	*	17	18	*	*	21	22	23	24	5	4	*	26	27	*	29	30	31	32	*	*	*	*	37	38	39	*	*	42	43	3		*	45	*	47	48	*	50	51	52	*	54	55	56	*	58	59	60	61	62	*	64	65	66	67	68	69	70	71	72	73	*	75	76	77	78	*	80	81	2	1	<p style="text-align: center;"><b>C20-1</b></p>  <p style="text-align: center;">KUM_NDWP_02F_GR</p>	<p style="text-align: center;"><b>C20-2</b></p>  <p style="text-align: center;">KUM_NDWP_02F_GR</p>
6	7	8	9	10	11	*	*	14	*	*	17	18	*	*	21	22	23	24	5	4																																																																	
*	26	27	*	29	30	31	32	*	*	*	*	37	38	39	*	*	42	43	3																																																																		
*	45	*	47	48	*	50	51	52	*	54	55	56	*	58	59	60	61	62																																																																			
*	64	65	66	67	68	69	70	71	72	73	*	75	76	77	78	*	80	81			2	1																																																															
<p style="text-align: center;"><b>C20-3</b></p>  <p style="text-align: center;">KUM_NDWP_02F_GR</p>	<p style="text-align: center;"><b>C20-4</b></p>  <p style="text-align: center;">KUM_NDWP_02F_GR</p>	<p style="text-align: center;"><b>C22</b></p>  <p style="text-align: center;">KET_090IWP_03F_B</p>	<p style="text-align: center;"><b>C23</b></p>  <p style="text-align: center;">BSH_ISA_03F_GR</p>																																																																																		
<p style="text-align: center;"><b>C27</b></p>  <p style="text-align: center;">AMP_JPT_02F_B</p>	<p style="text-align: center;"><b>C28</b></p>  <p style="text-align: center;">KSP_VDACC0EB_05F_B</p>	<p style="text-align: center;"><b>C29</b></p>  <p style="text-align: center;">AMP_EJWP_04F_B</p>	<p style="text-align: center;"><b>C30</b></p>  <p style="text-align: center;">KUM_NMWP_04M_B</p>																																																																																		
<p style="text-align: center;"><b>C32</b></p>  <p style="text-align: center;">KUM_JFC_02F_B</p>	<p style="text-align: center;"><b>C39</b></p>  <p style="text-align: center;">AMP_JPT_03F_B_S1</p>	<p style="text-align: center;"><b>C40</b></p>  <p style="text-align: center;">AMP_JPT_03F_B_S1</p>	<p style="text-align: center;"><b>C41</b></p>  <p style="text-align: center;">AMP_JPT_03F_B_BOSCH</p>																																																																																		

MFI控制系统 (续)

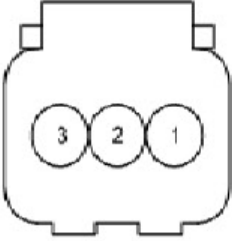
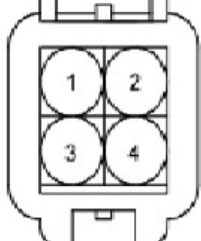
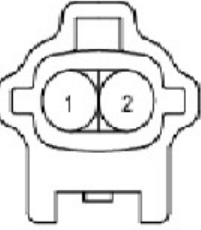
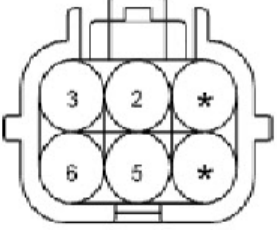
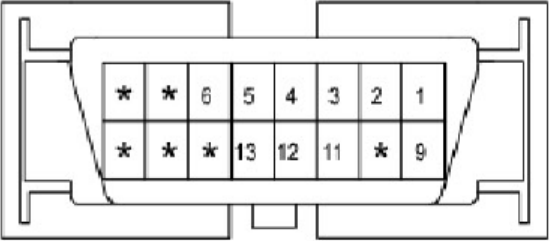
<p style="text-align: center;"><b>C43</b></p>  <p style="text-align: center;">KUM_WTS_03F_B</p>	<p style="text-align: center;"><b>E25</b></p>  <p style="text-align: center;">KUM_NMWP_04M_B</p>	<p style="text-align: center;"><b>E26</b></p>  <p style="text-align: center;">KET_090IWP_02M_B</p>	<p style="text-align: center;"><b>F18</b></p>  <p style="text-align: center;">KET_SWP_06F_B</p>
<p style="text-align: center;"><b>M26</b></p>  <p style="text-align: center;">MLX_OBDII_16F_B_SIN</p>	<p style="text-align: center;">BLANK</p>	<p style="text-align: center;">BLANK</p>	<p style="text-align: center;">BLANK</p>