

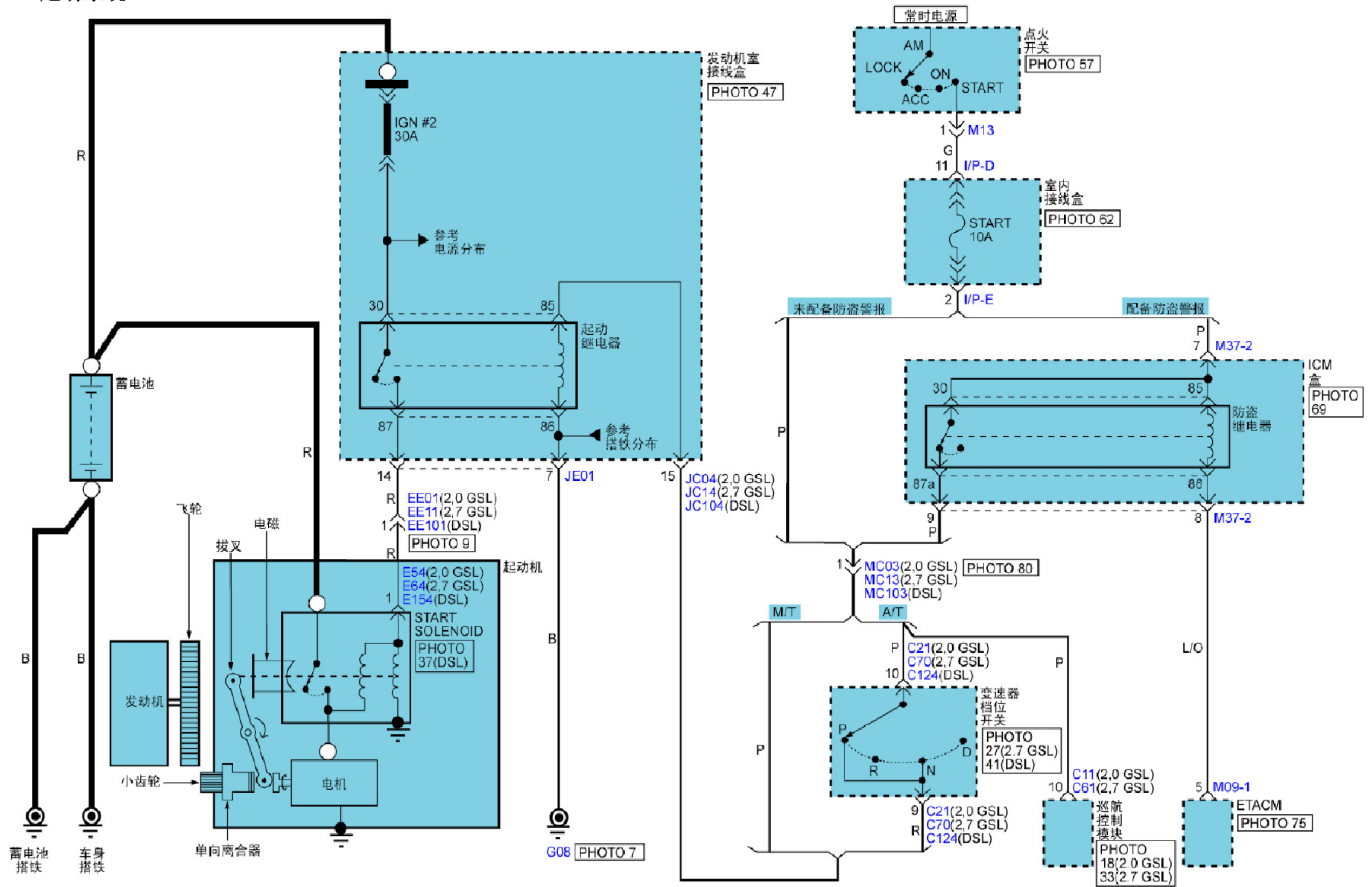

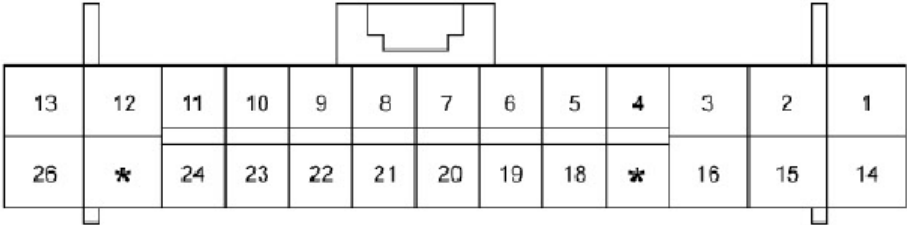

### 2.4 起动系统

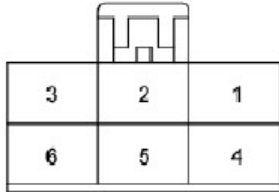
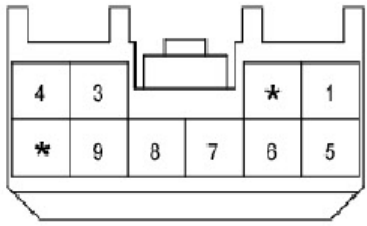

起动系统 (续)

<p>C21/C70/C124</p>  <p>KET_SSD_10F_B_A</p>	<p>E54</p>  <p>KET_250WP_01F_B</p>	<p>E64</p>  <p>AMP_PLM2_01F_B</p>	<p>E154</p>  <p>KUM_DSD_01F_B</p>
<p>M09-1</p>  <p>AMP_0407_26F_W_HD</p>		<p>M13</p>  <p>KUM_DSD_06F_B</p>	<p>M37-2</p>  <p>AMP_090III_10F_W</p>
Empty space for additional diagrams			