

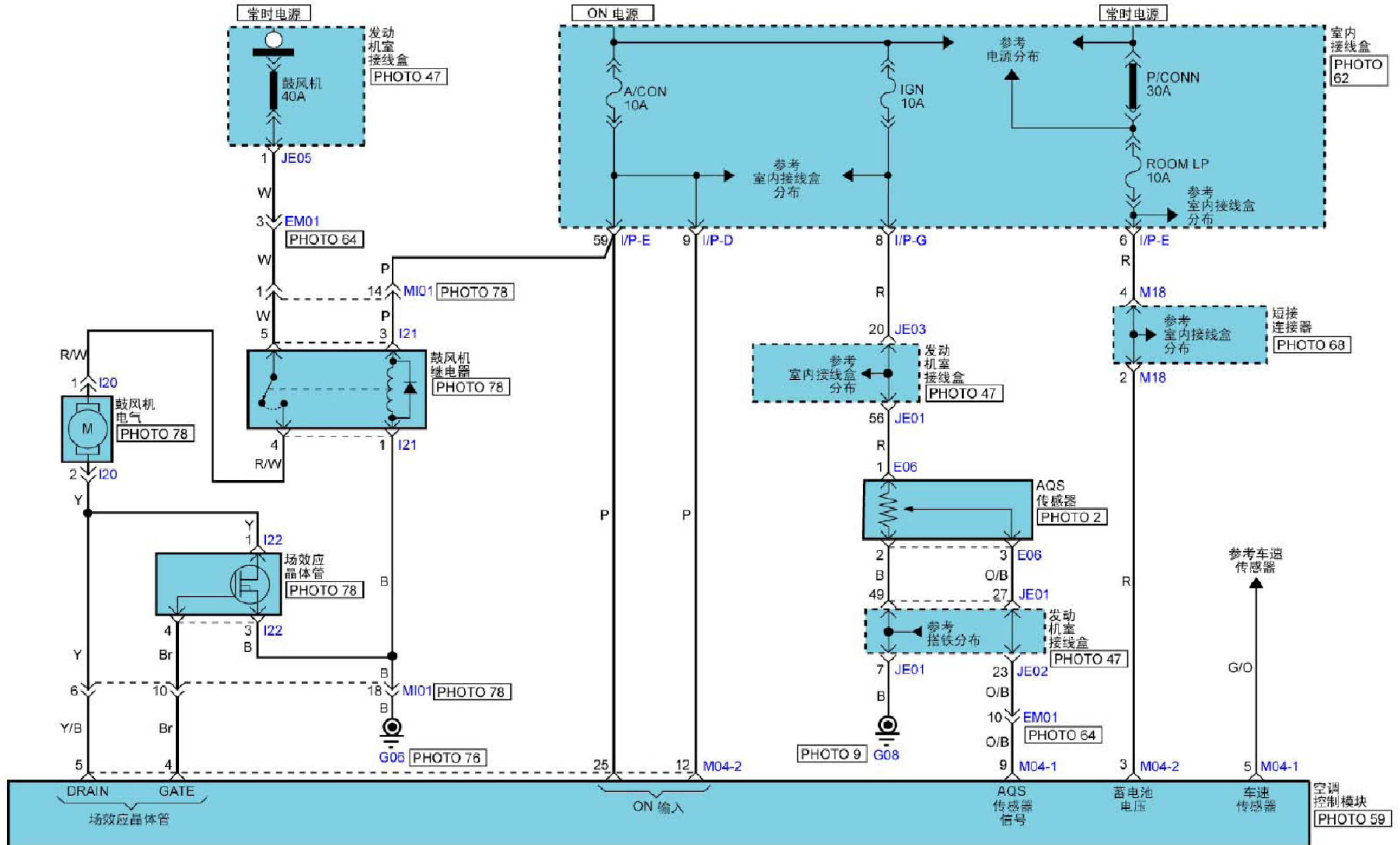

2.40 鼓风机和空调控制系统（自动）

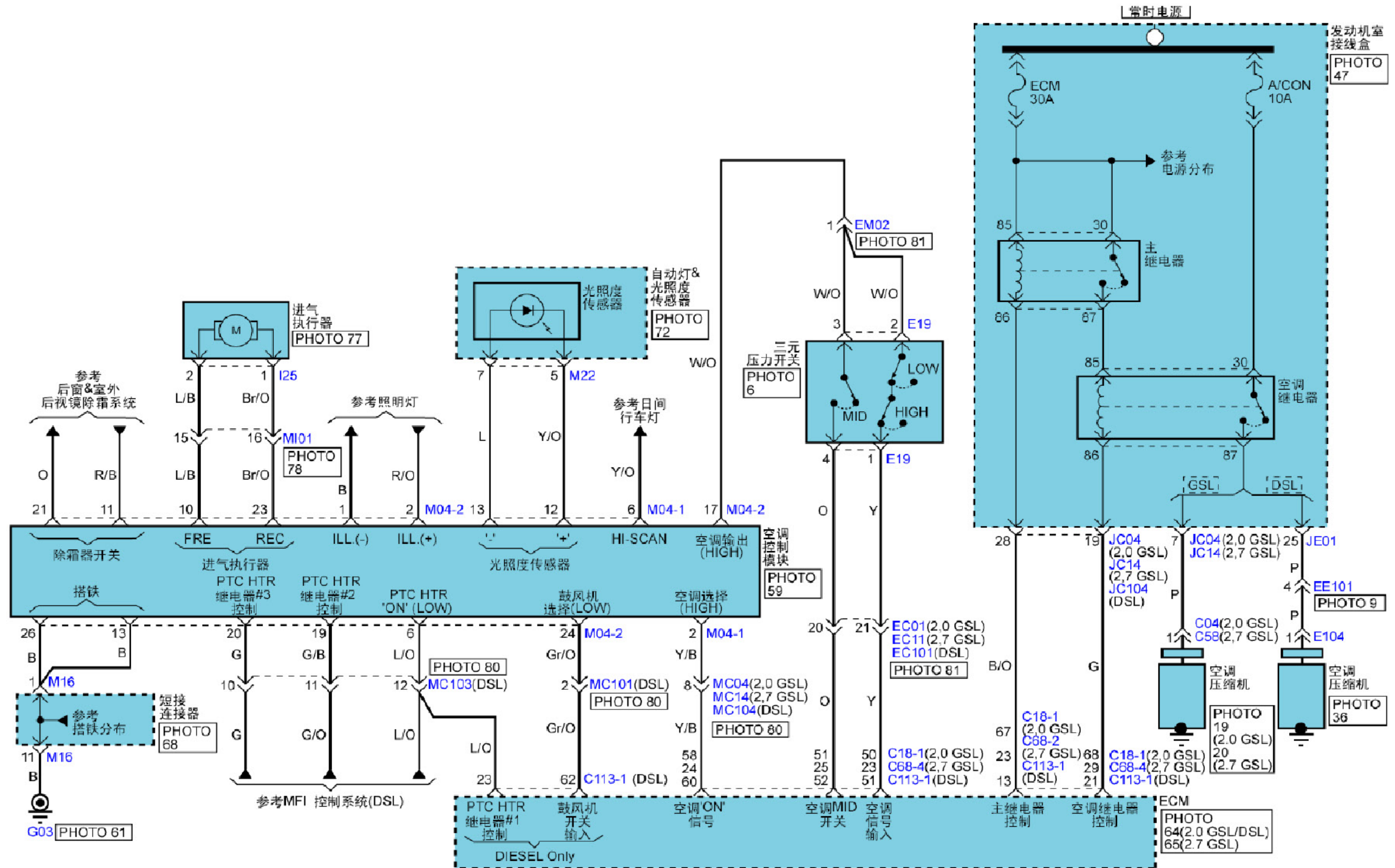

鼓风机和空调控制系统 (自动) (续)

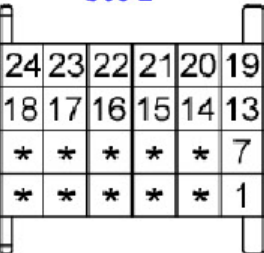
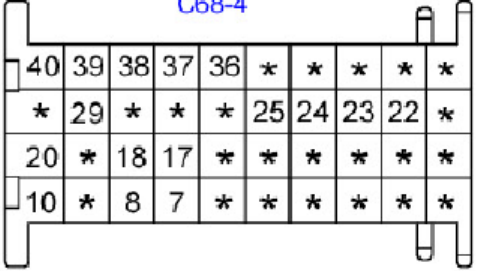
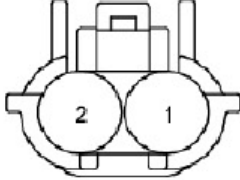
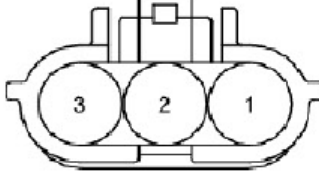
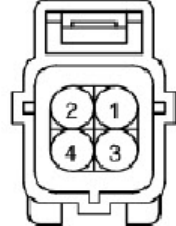
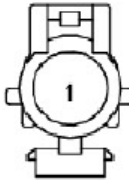
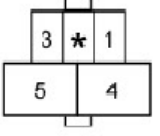
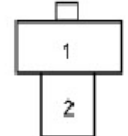
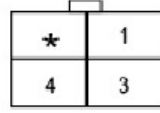
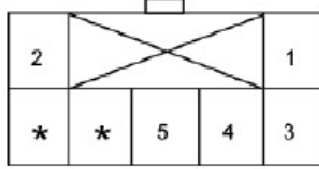
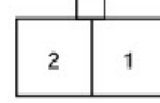
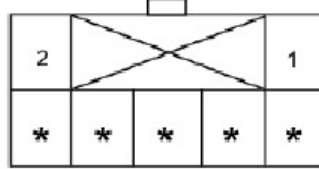
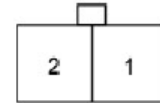
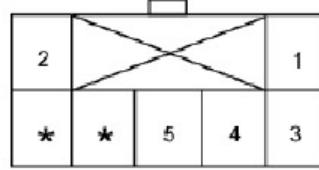
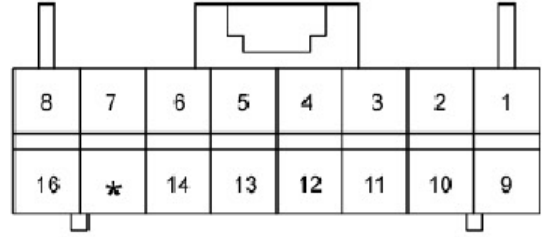

鼓风机和空调控制系统 (自动) (续)

<p>C04</p>  <p>KUM_NMWP_01F_B</p>	<p>C18-1</p> <table border="1"> <tr><td>6</td><td>7</td><td>8</td><td>9</td><td>10</td><td>11</td><td>*</td><td>*</td><td>14</td><td>*</td><td>*</td><td>17</td><td>18</td><td>*</td><td>*</td><td>21</td><td>22</td><td>23</td><td>24</td><td>5</td><td>4</td></tr> <tr><td>*</td><td>26</td><td>27</td><td>*</td><td>29</td><td>30</td><td>31</td><td>32</td><td>*</td><td>*</td><td>*</td><td>*</td><td>37</td><td>38</td><td>39</td><td>*</td><td>*</td><td>42</td><td>43</td><td colspan="2">3</td></tr> <tr><td>*</td><td>45</td><td>*</td><td>47</td><td>48</td><td>*</td><td>50</td><td>51</td><td>52</td><td>*</td><td>54</td><td>55</td><td>56</td><td>*</td><td>58</td><td>59</td><td>60</td><td>61</td><td>62</td><td colspan="2"></td></tr> <tr><td>*</td><td>64</td><td>65</td><td>66</td><td>67</td><td>68</td><td>69</td><td>70</td><td>71</td><td>72</td><td>73</td><td>*</td><td>75</td><td>76</td><td>77</td><td>78</td><td>*</td><td>80</td><td>81</td><td>2</td><td>1</td></tr> </table> <p>KET_ECU_81F</p>	6	7	8	9	10	11	*	*	14	*	*	17	18	*	*	21	22	23	24	5	4	*	26	27	*	29	30	31	32	*	*	*	*	37	38	39	*	*	42	43	3		*	45	*	47	48	*	50	51	52	*	54	55	56	*	58	59	60	61	62			*	64	65	66	67	68	69	70	71	72	73	*	75	76	77	78	*	80	81	2	1	<p>C68-2</p>  <p>AMP_ECU_24F_B_134P</p>
6	7	8	9	10	11	*	*	14	*	*	17	18	*	*	21	22	23	24	5	4																																																																		
*	26	27	*	29	30	31	32	*	*	*	*	37	38	39	*	*	42	43	3																																																																			
*	45	*	47	48	*	50	51	52	*	54	55	56	*	58	59	60	61	62																																																																				
*	64	65	66	67	68	69	70	71	72	73	*	75	76	77	78	*	80	81	2	1																																																																		
<p>C68-4</p>  <p>AMP_ECU_40F_B_134P</p>	<p>C113-1</p> <table border="1"> <tr><td>*</td><td>*</td><td>*</td><td>9</td><td>10</td><td>11</td><td>12</td><td>13</td><td>14</td><td>15</td><td>16</td><td>17</td><td>18</td><td>19</td><td>20</td><td>21</td><td>*</td><td>23</td><td>24</td><td>5</td><td>4</td></tr> <tr><td>*</td><td>*</td><td>*</td><td>*</td><td>*</td><td>*</td><td>*</td><td>*</td><td>*</td><td>*</td><td>*</td><td>*</td><td>*</td><td>*</td><td>*</td><td>40</td><td>*</td><td>*</td><td>*</td><td colspan="2">3</td></tr> <tr><td>*</td><td>*</td><td>*</td><td>47</td><td>48</td><td>49</td><td>*</td><td>51</td><td>52</td><td>53</td><td>54</td><td>*</td><td>56</td><td>*</td><td>58</td><td>59</td><td>60</td><td>61</td><td>62</td><td colspan="2"></td></tr> <tr><td>*</td><td>*</td><td>*</td><td>*</td><td>*</td><td>*</td><td>*</td><td>*</td><td>*</td><td>*</td><td>*</td><td>74</td><td>75</td><td>76</td><td>77</td><td>78</td><td>79</td><td>80</td><td>81</td><td>2</td><td>1</td></tr> </table> <p>KET_ECU_81F</p>	*	*	*	9	10	11	12	13	14	15	16	17	18	19	20	21	*	23	24	5	4	*	*	*	*	*	*	*	*	*	*	*	*	*	*	*	40	*	*	*	3		*	*	*	47	48	49	*	51	52	53	54	*	56	*	58	59	60	61	62			*	*	*	*	*	*	*	*	*	*	*	74	75	76	77	78	79	80	81	2	1	<p>E05</p>  <p>KET_SWP_02F_B</p>
*	*	*	9	10	11	12	13	14	15	16	17	18	19	20	21	*	23	24	5	4																																																																		
*	*	*	*	*	*	*	*	*	*	*	*	*	*	*	40	*	*	*	3																																																																			
*	*	*	47	48	49	*	51	52	53	54	*	56	*	58	59	60	61	62																																																																				
*	*	*	*	*	*	*	*	*	*	*	74	75	76	77	78	79	80	81	2	1																																																																		
<p>E06</p>  <p>KET_SWP_03F_B</p>	<p>E19</p>  <p>AMP_EJMP_04F_B</p>	<p>C58/E104</p>  <p>KET_SWP_01F_B</p>	<p>I21</p>  <p>KET_MG612109</p>																																																																																			
<p>I20</p>  <p>KUM_PH776_02025</p>	<p>I22</p>  <p>KUM_PH776_04027</p>	<p>I23</p>  <p>KUM_PH845_07020</p>	<p>I24</p>  <p>AMP_174463_1</p>																																																																																			
<p>I25</p>  <p>KUM_PH845_07020</p>	<p>I26</p>  <p>AMP_174463_1</p>	<p>I27</p>  <p>KUM_PH845_07020</p>	<p>M04-1</p>  <p>AMP_0407_16F_W_040</p>																																																																																			

鼓风机和空调控制系统（自动）（续）

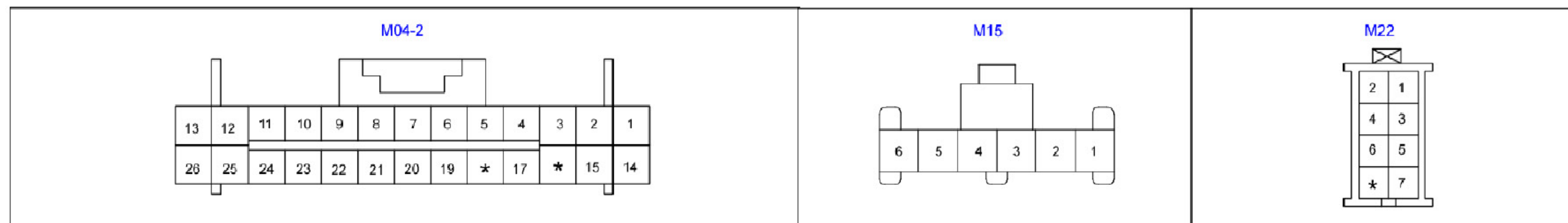

LAUNCH