

2.28 喇叭线路图

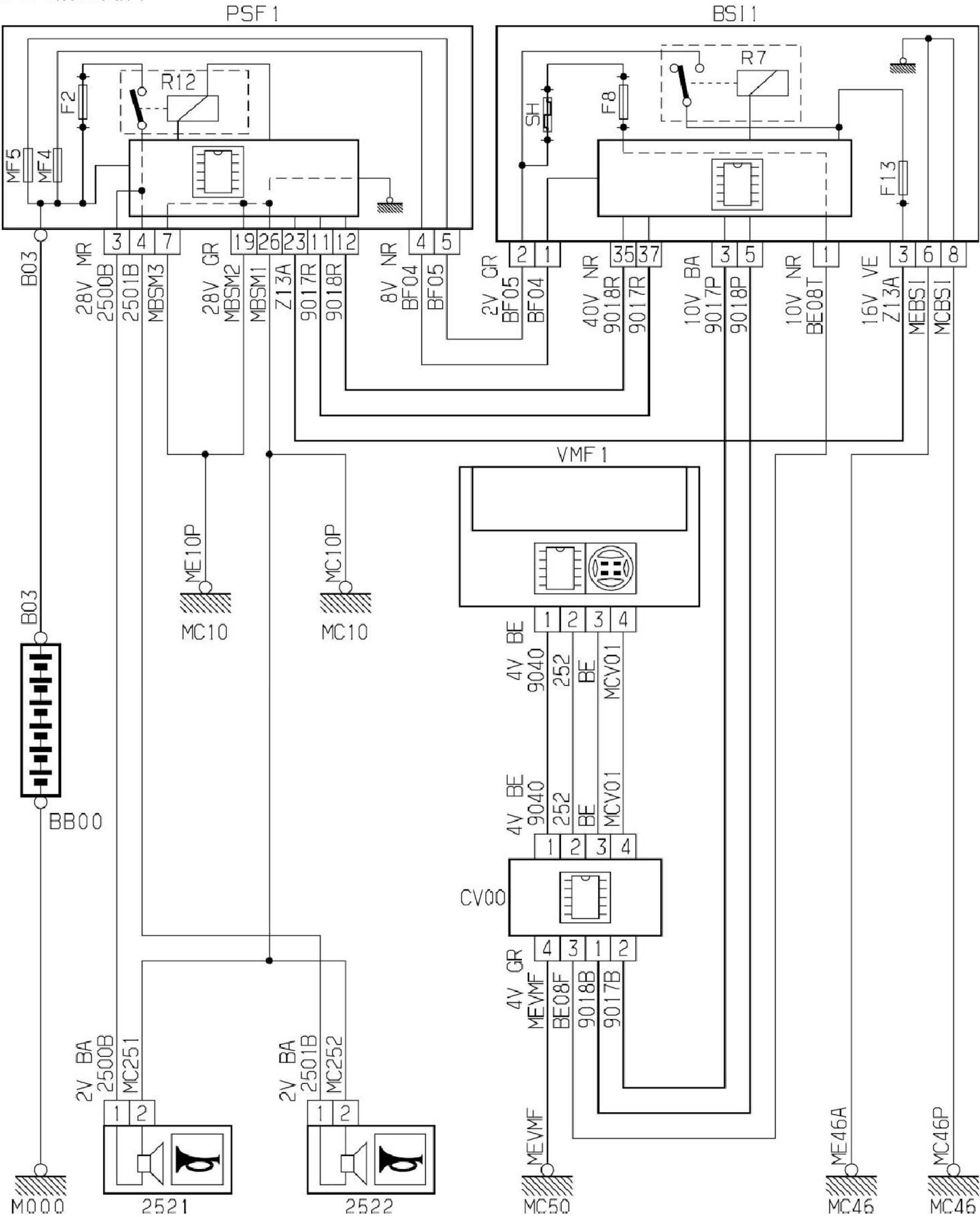

2.28.1 线路

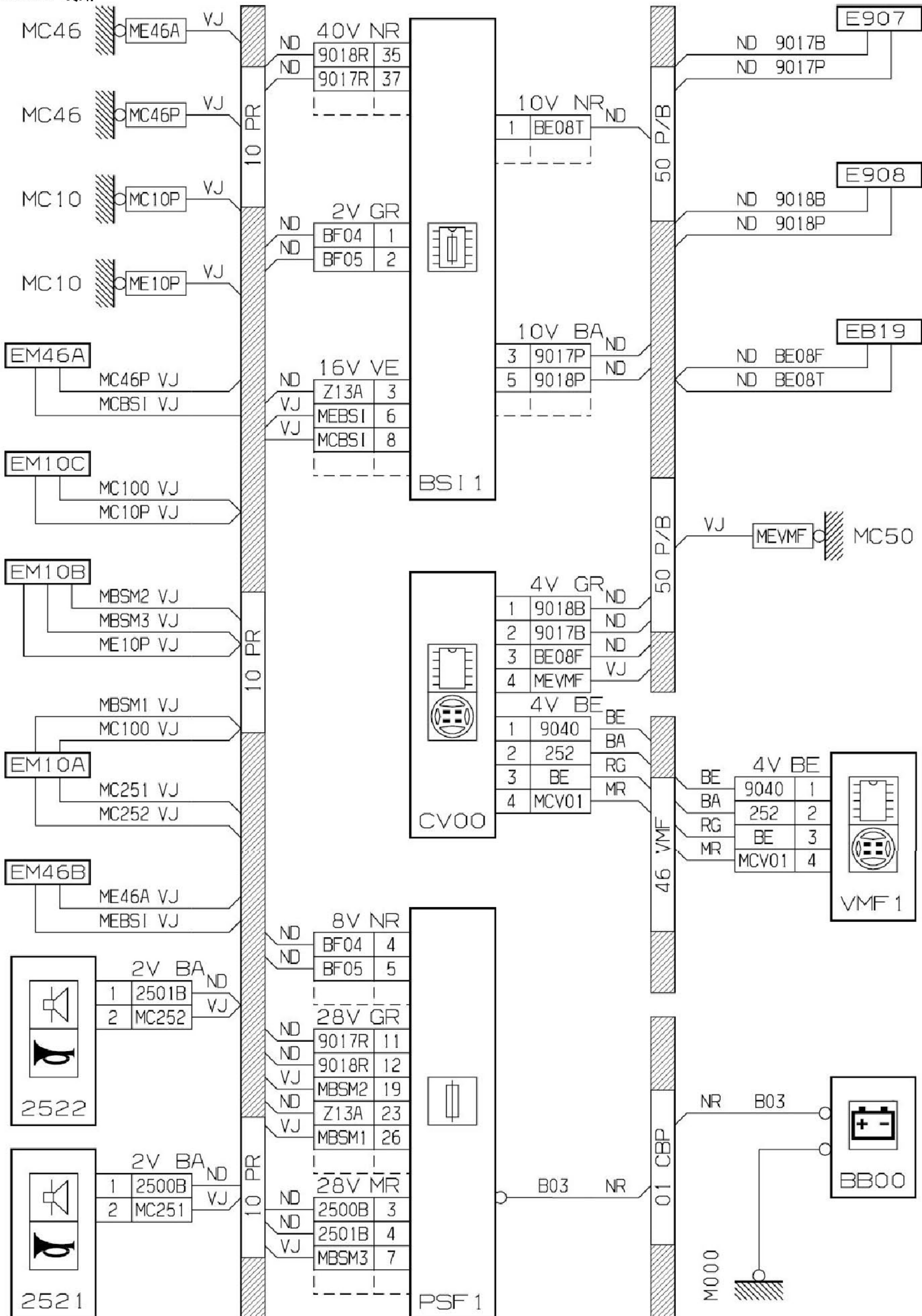

2.28.2 安装

