

2.27 喇叭线路图

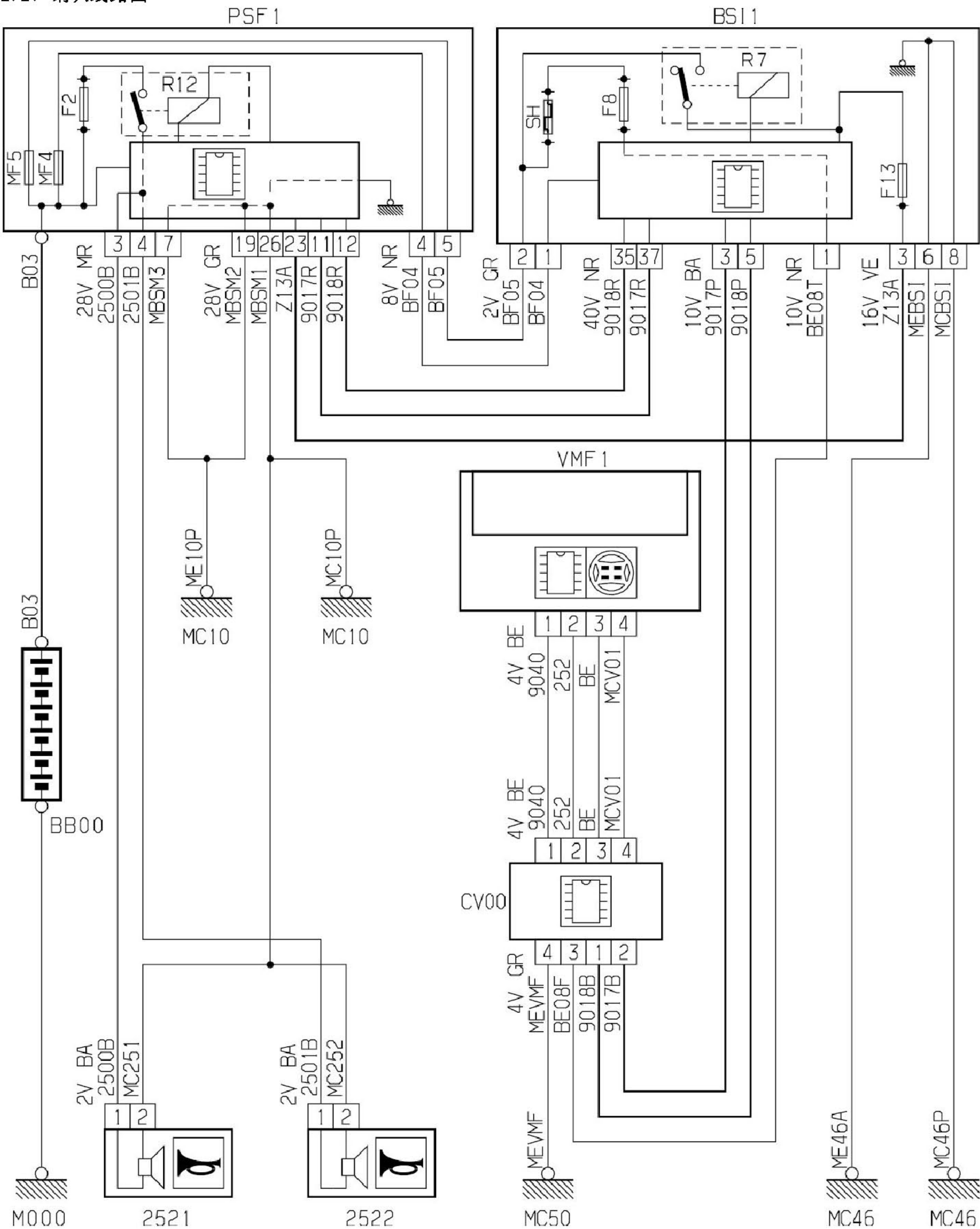

2.27.1 线路

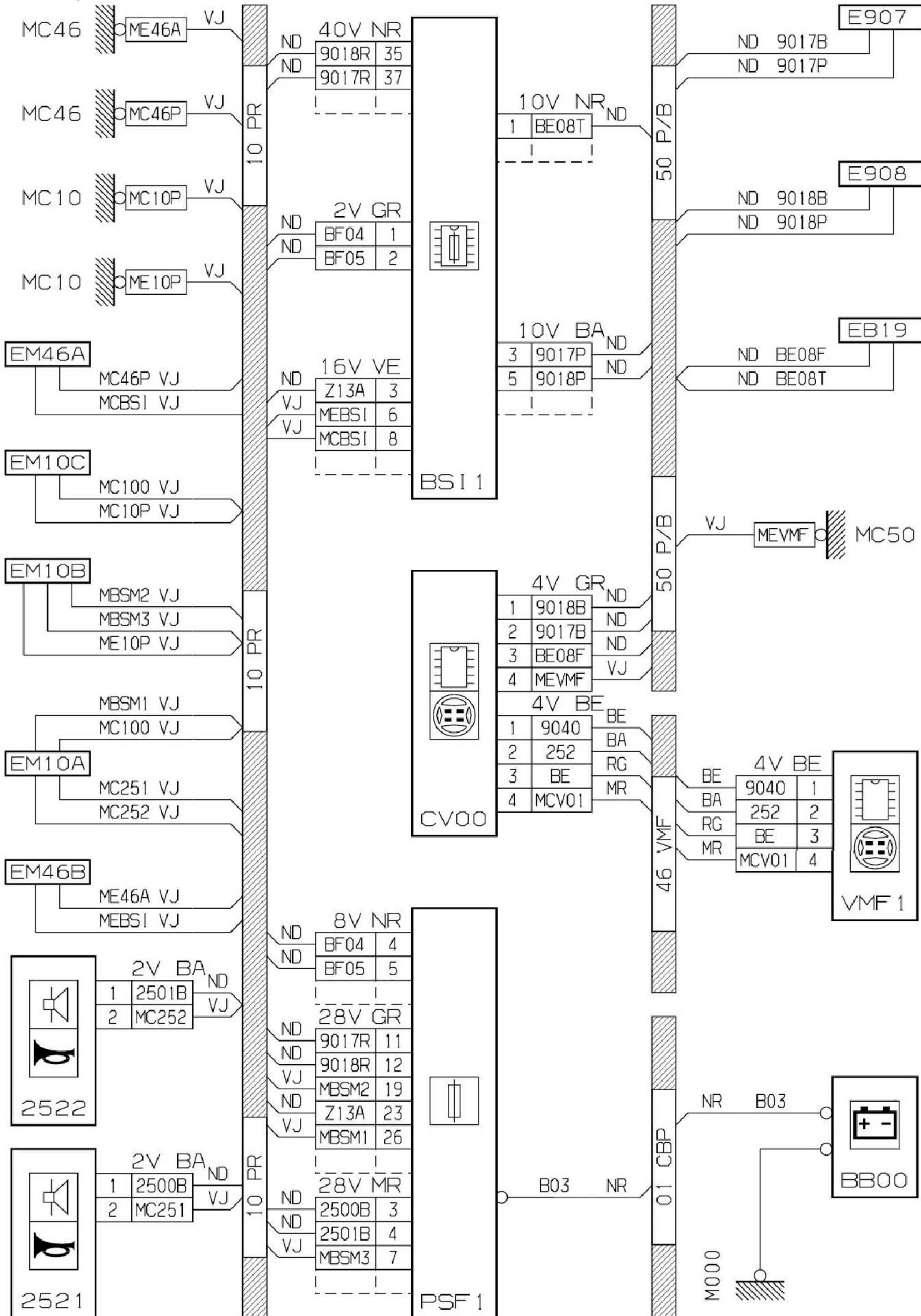

2.27.2 安装

