

2.3 3厢发动机冷却线路图

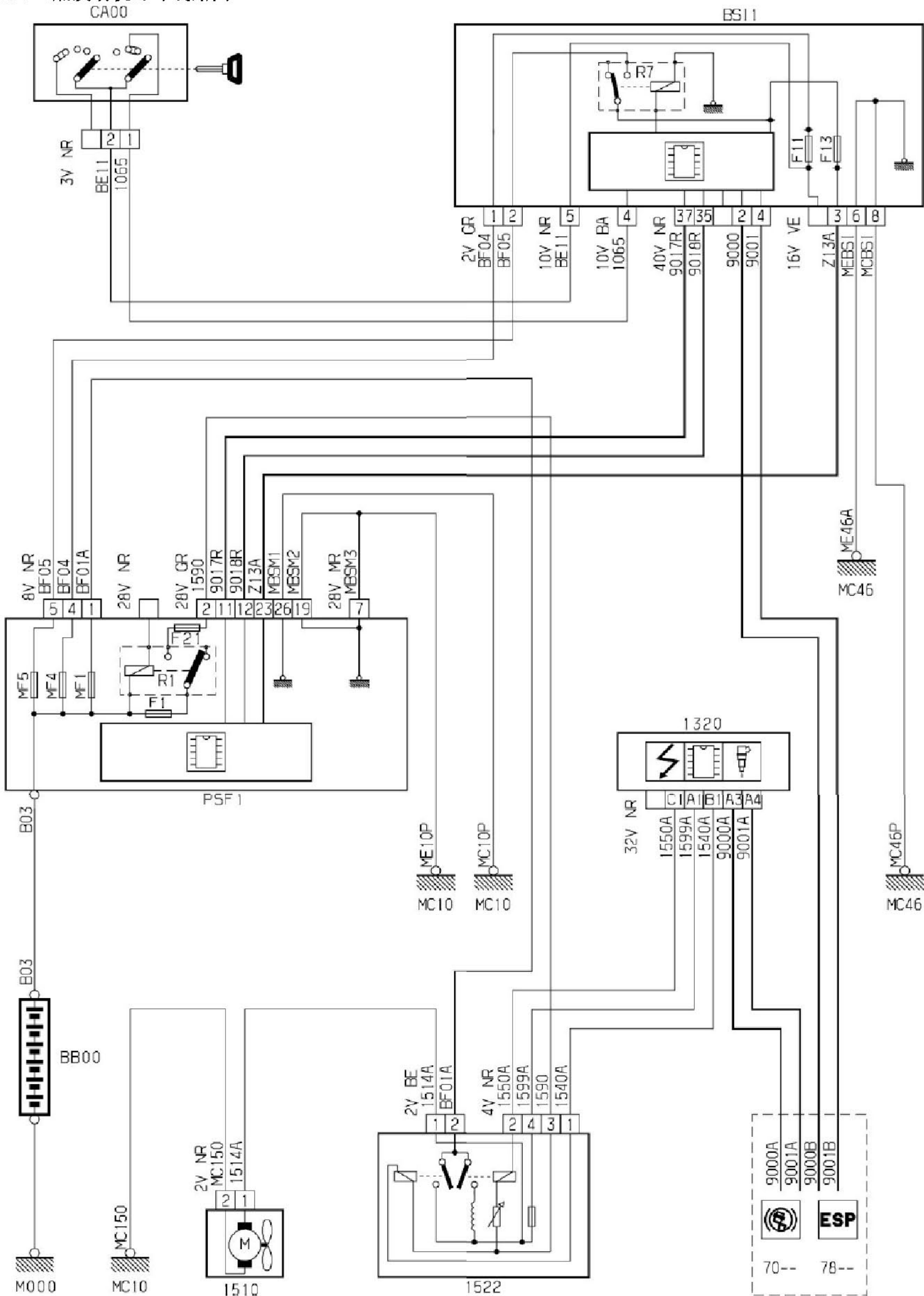

2.3.1 线路

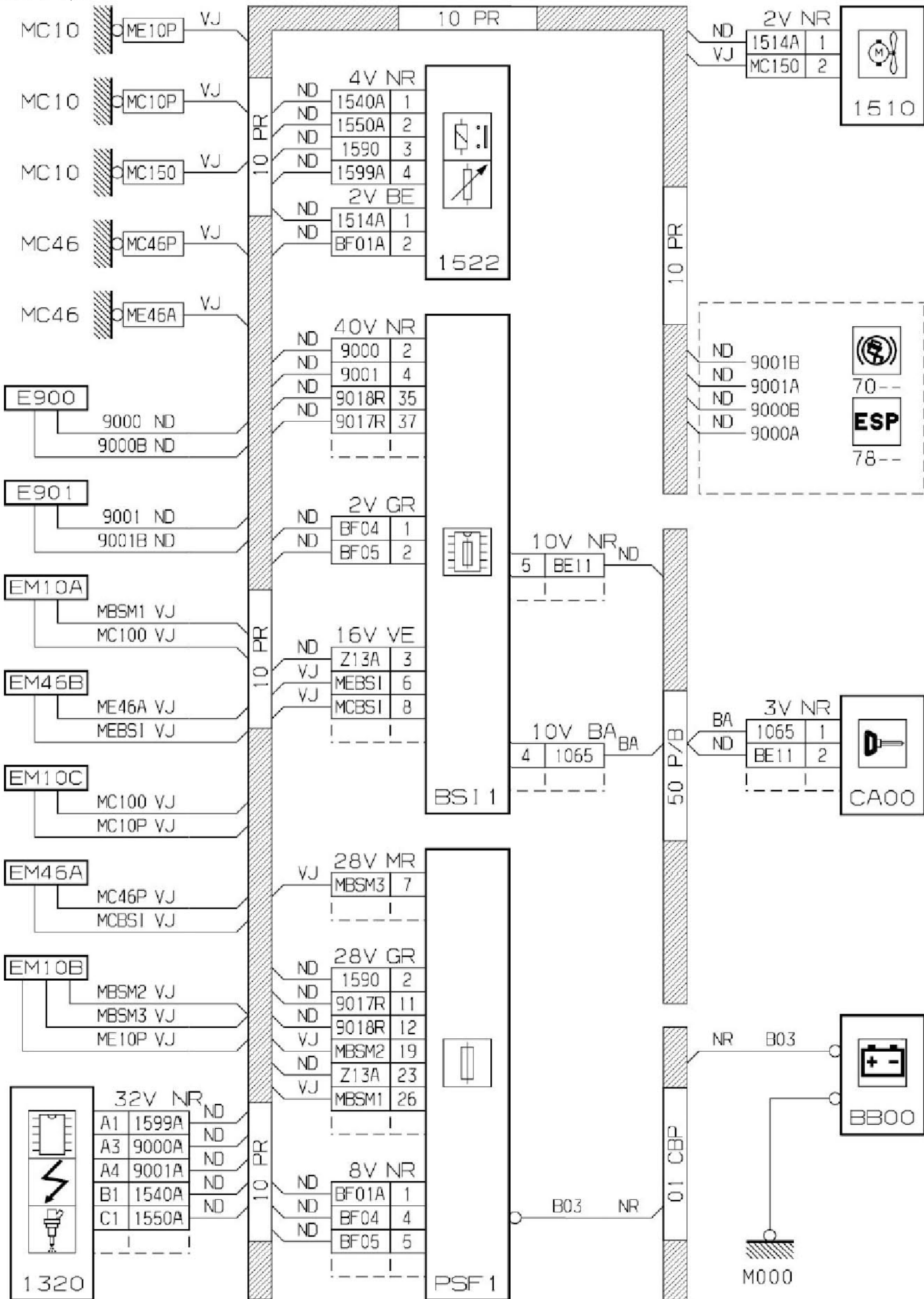

2.3.2 安装

