

2.2 2厢发动机冷却线路图

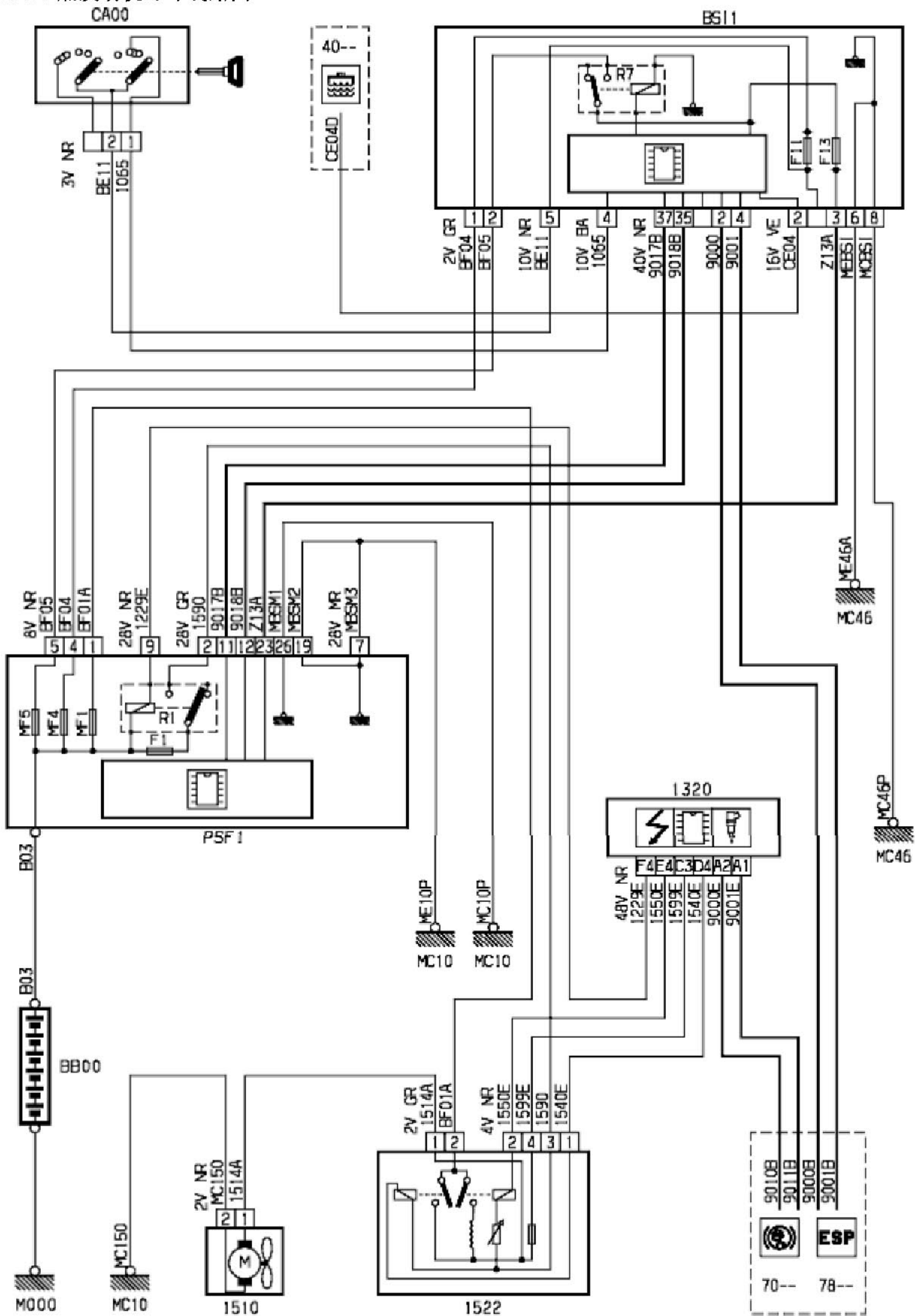

2.2.1 线路

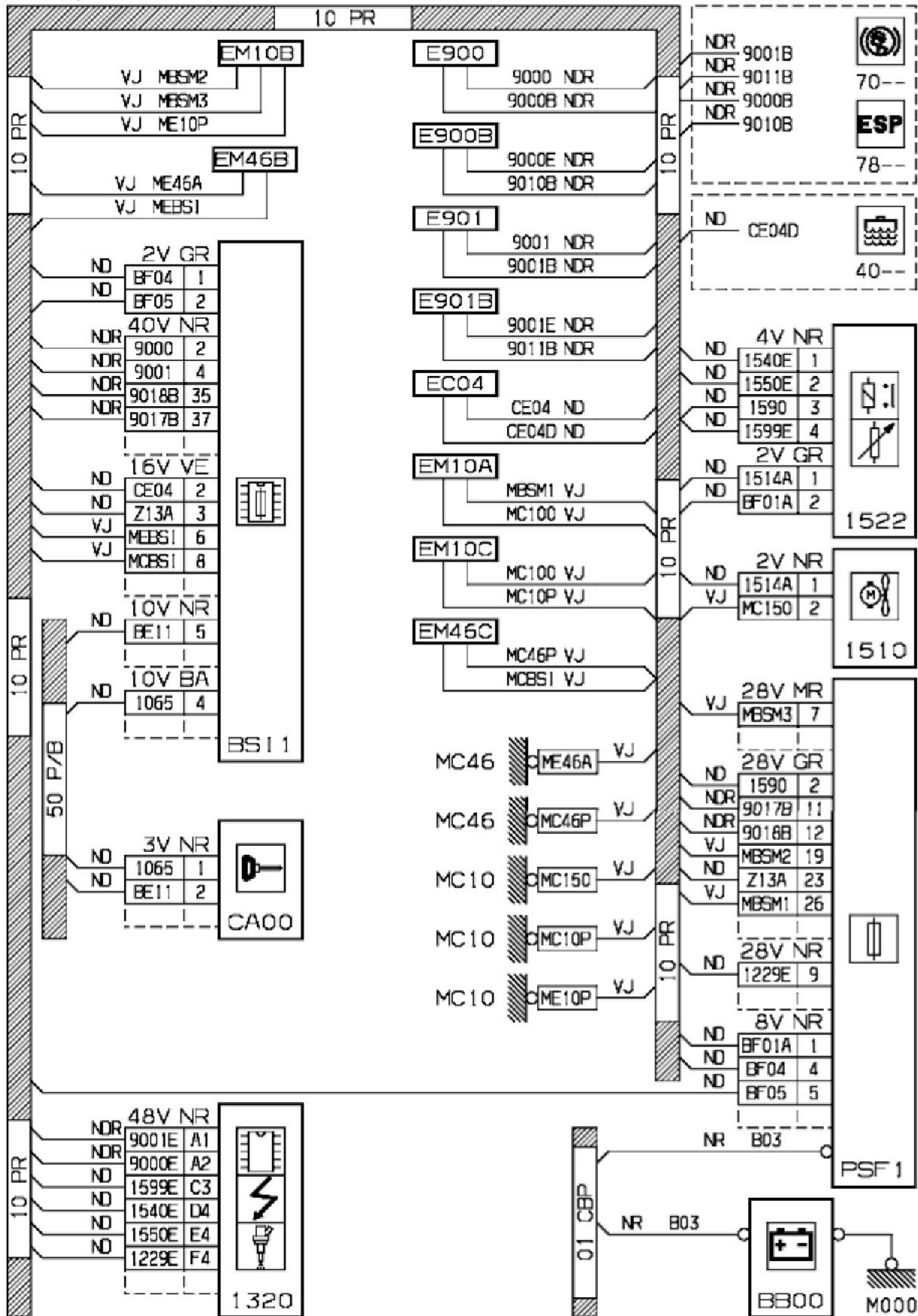

2.2.2 安装

