

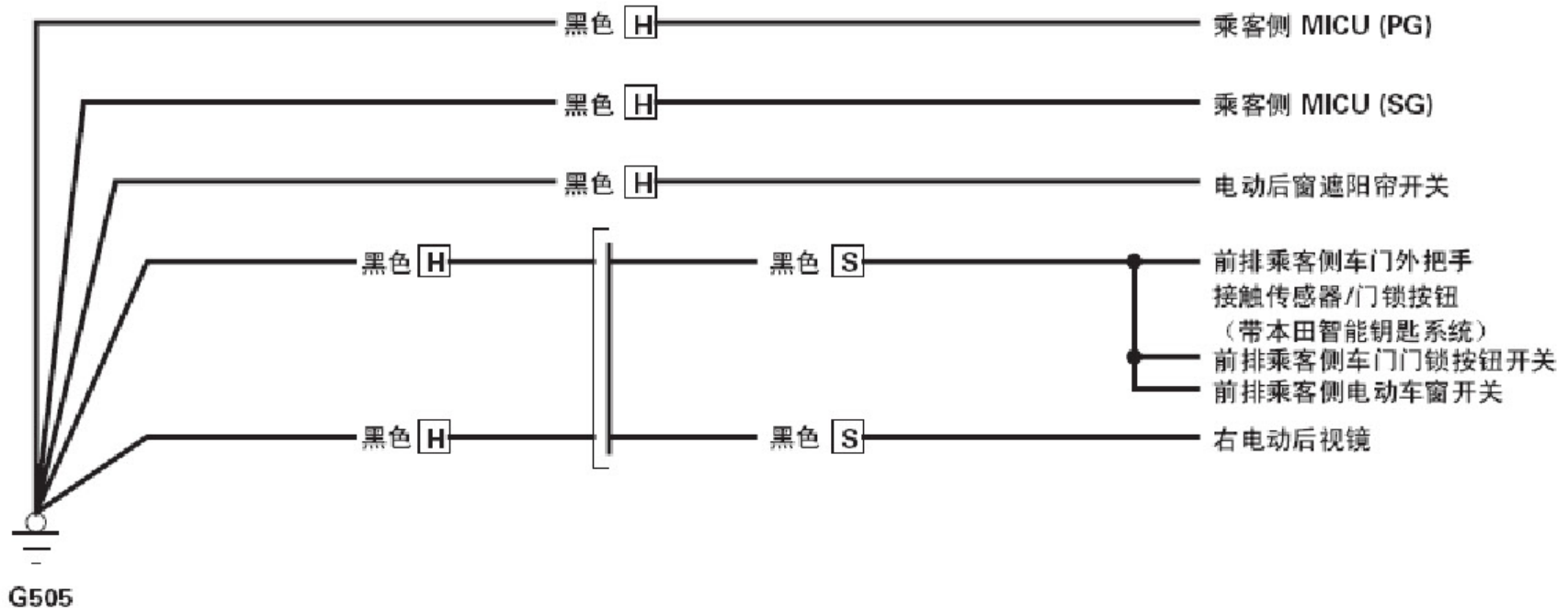

接地分布 (续)

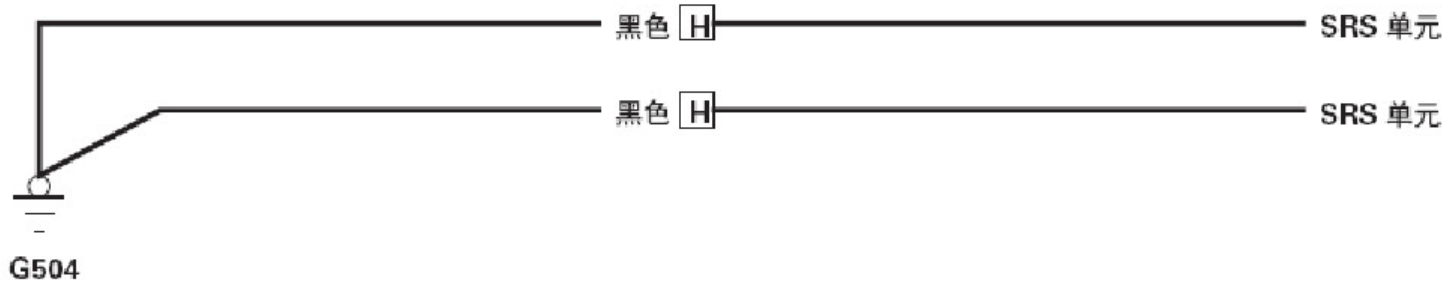
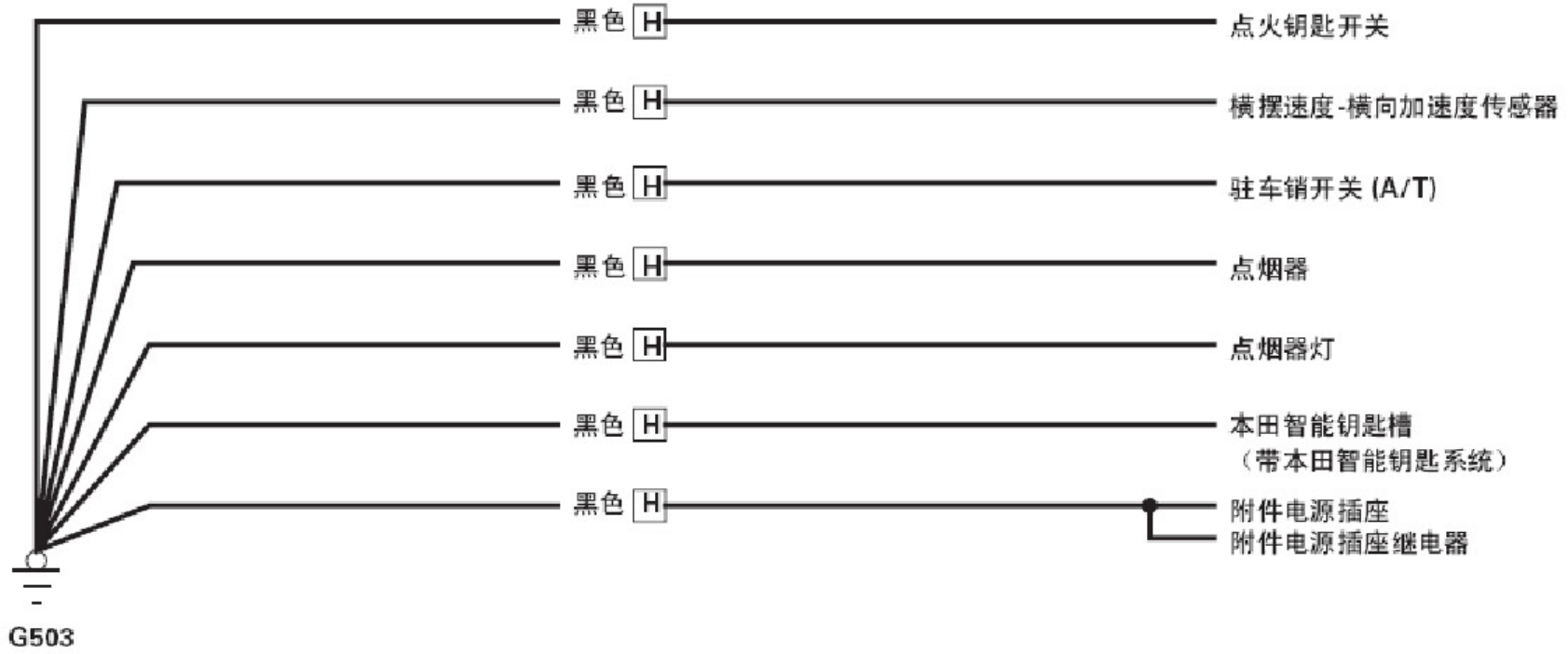

H : 仪表板线束  
S : 前排乘客侧车门线束

接地分布 (续)

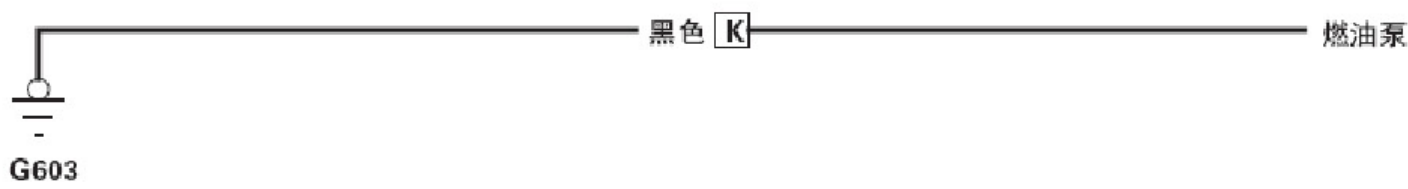
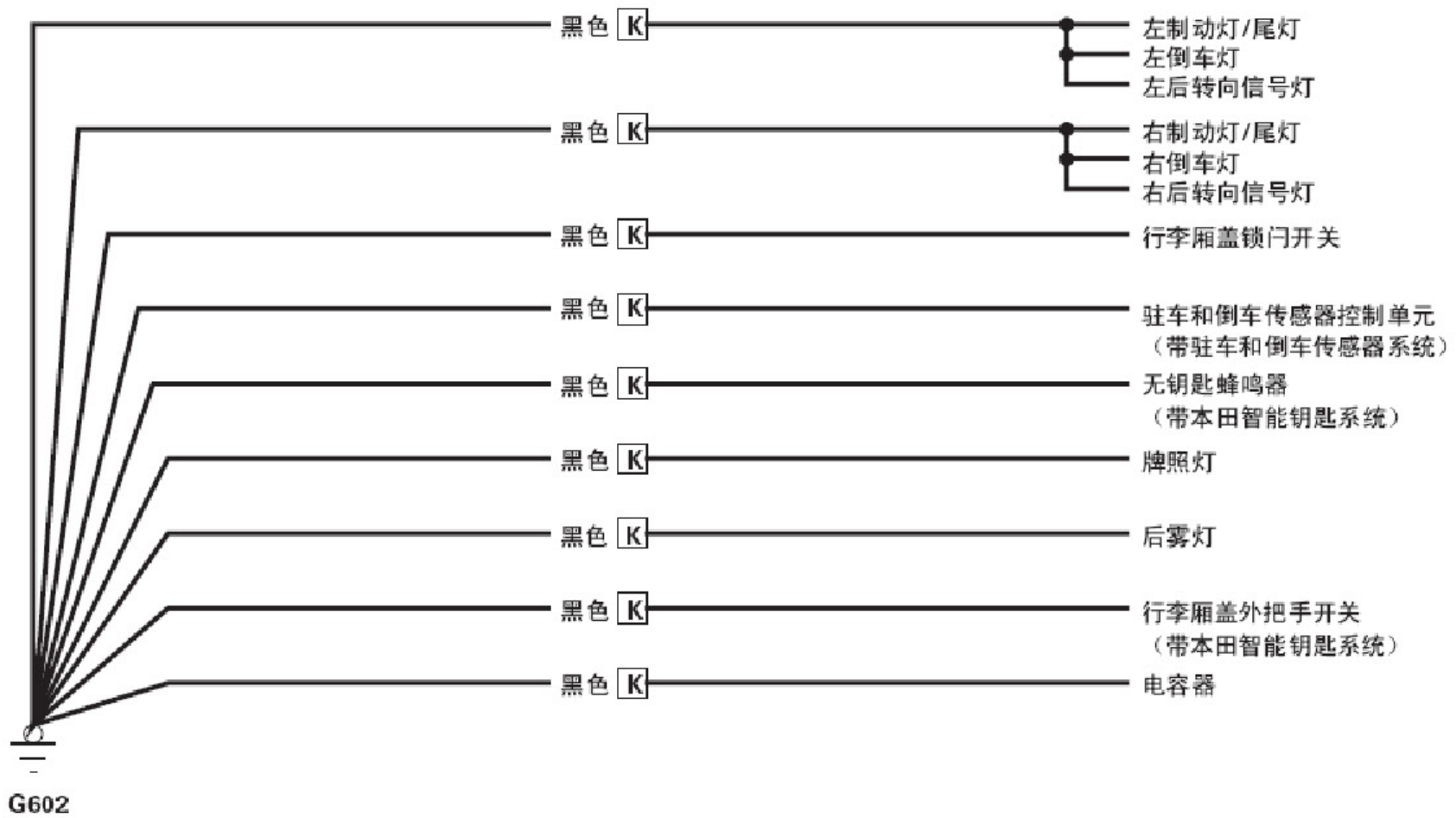
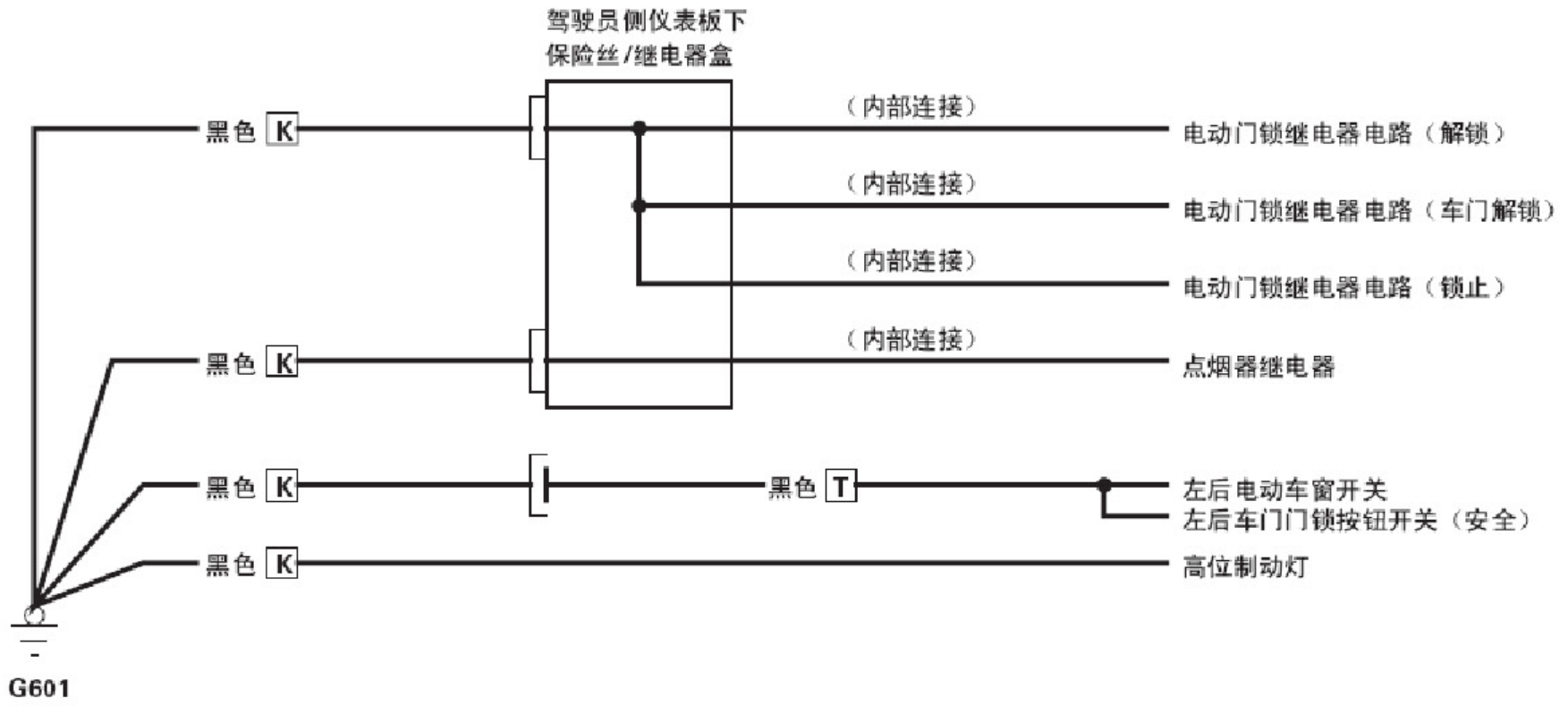

**K** : 左侧线束  
**T** : 左后车门线束

接地分布 (续)

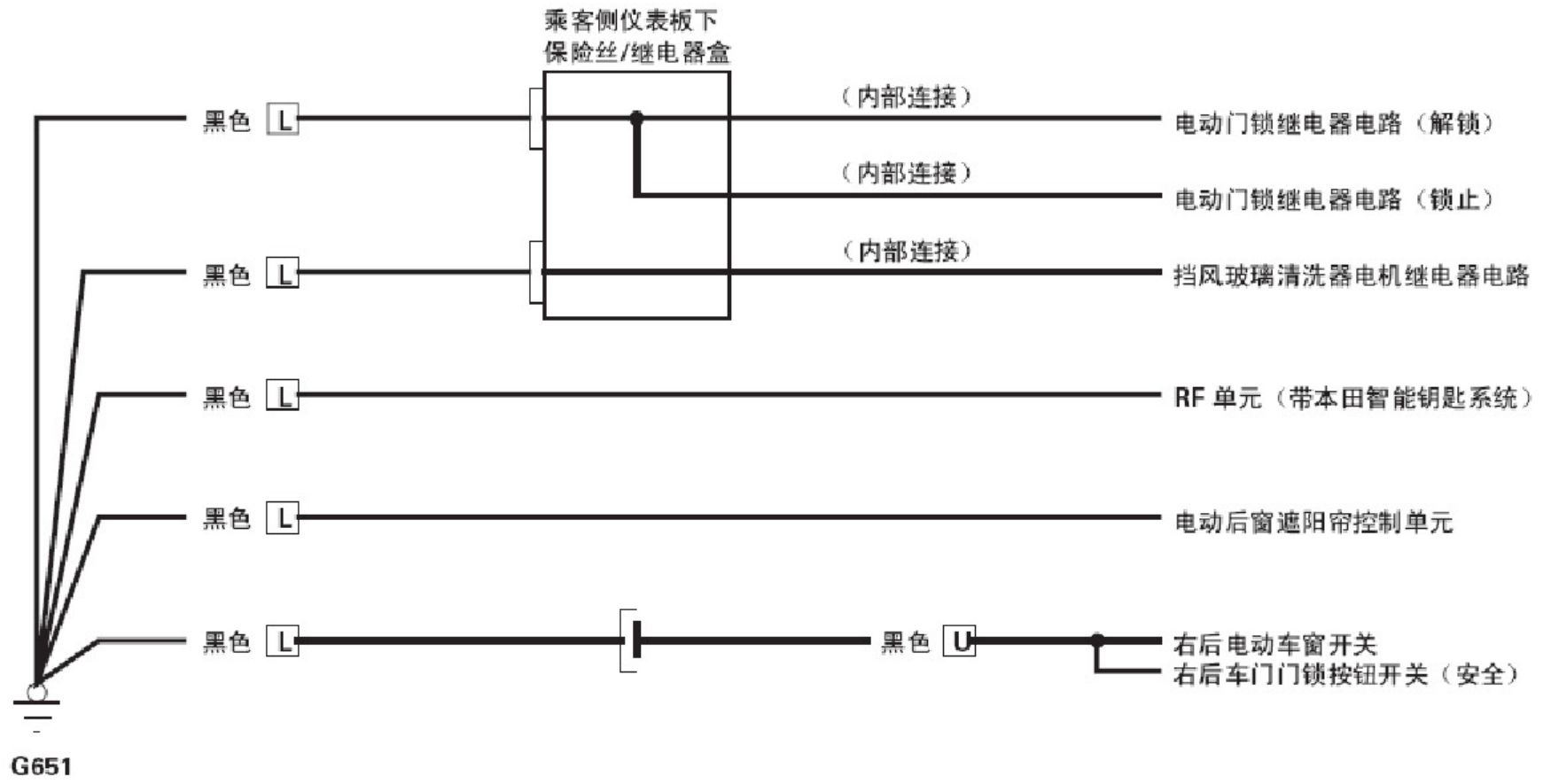

- L : 右侧线束
- U : 右后车门线束

LAUNCH

接地分布 (续)

\*1: 带前排乘客侧电动座椅  
\*2: 不带前排乘客侧电动座椅

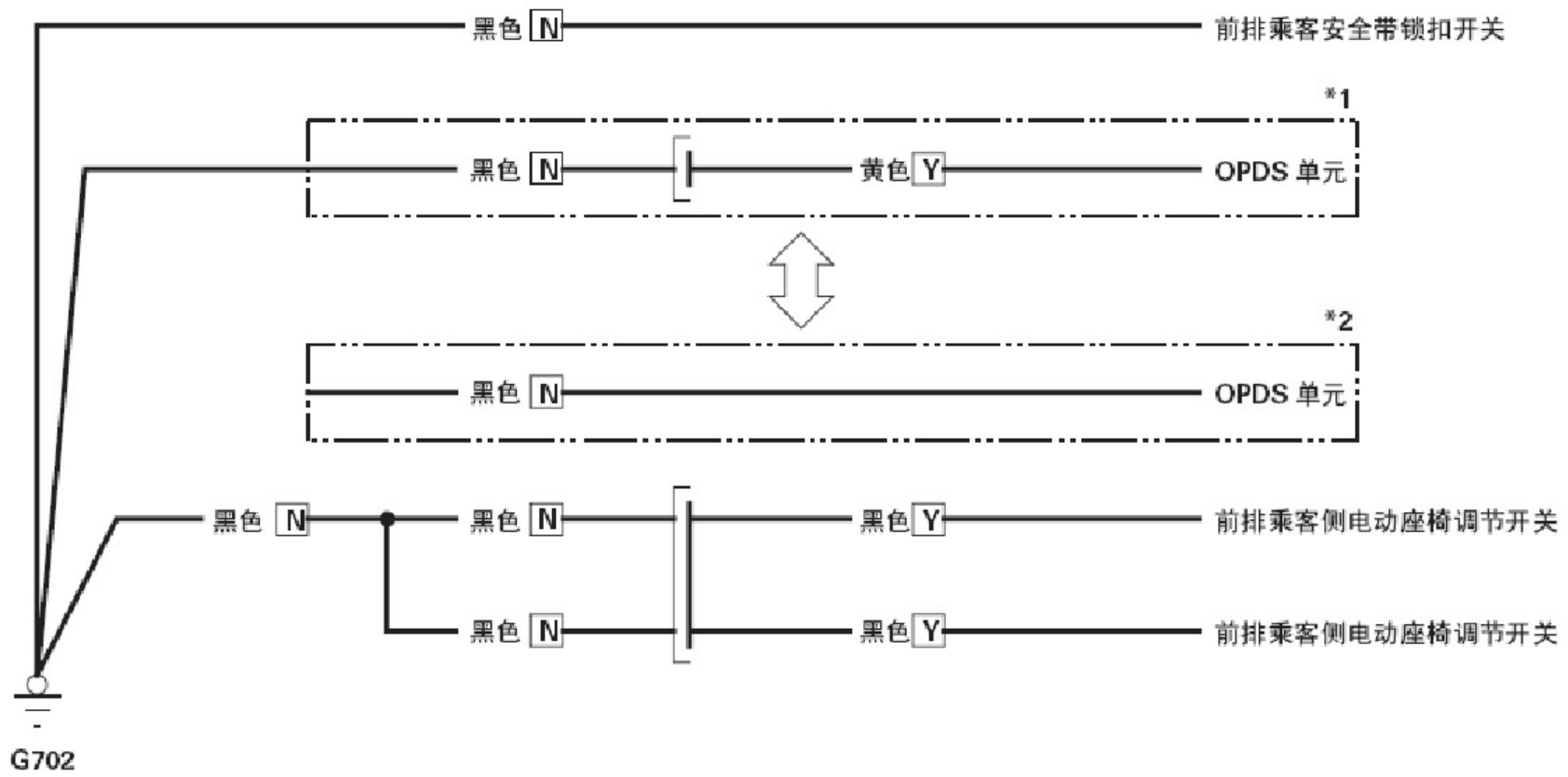
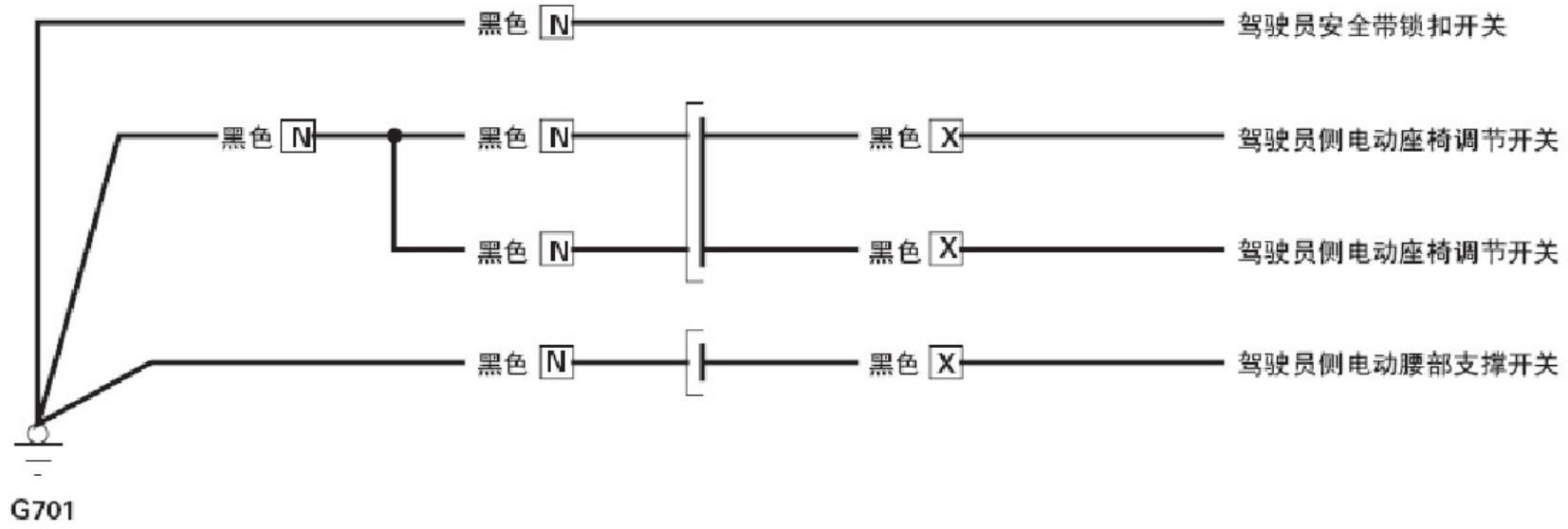

**N** : SRS 地板线束  
**W** : 后窗除雾器搭铁线

**X** : 驾驶员侧座椅线束  
**Y** : 前排乘客侧座椅线束