

2.2 电喷系统

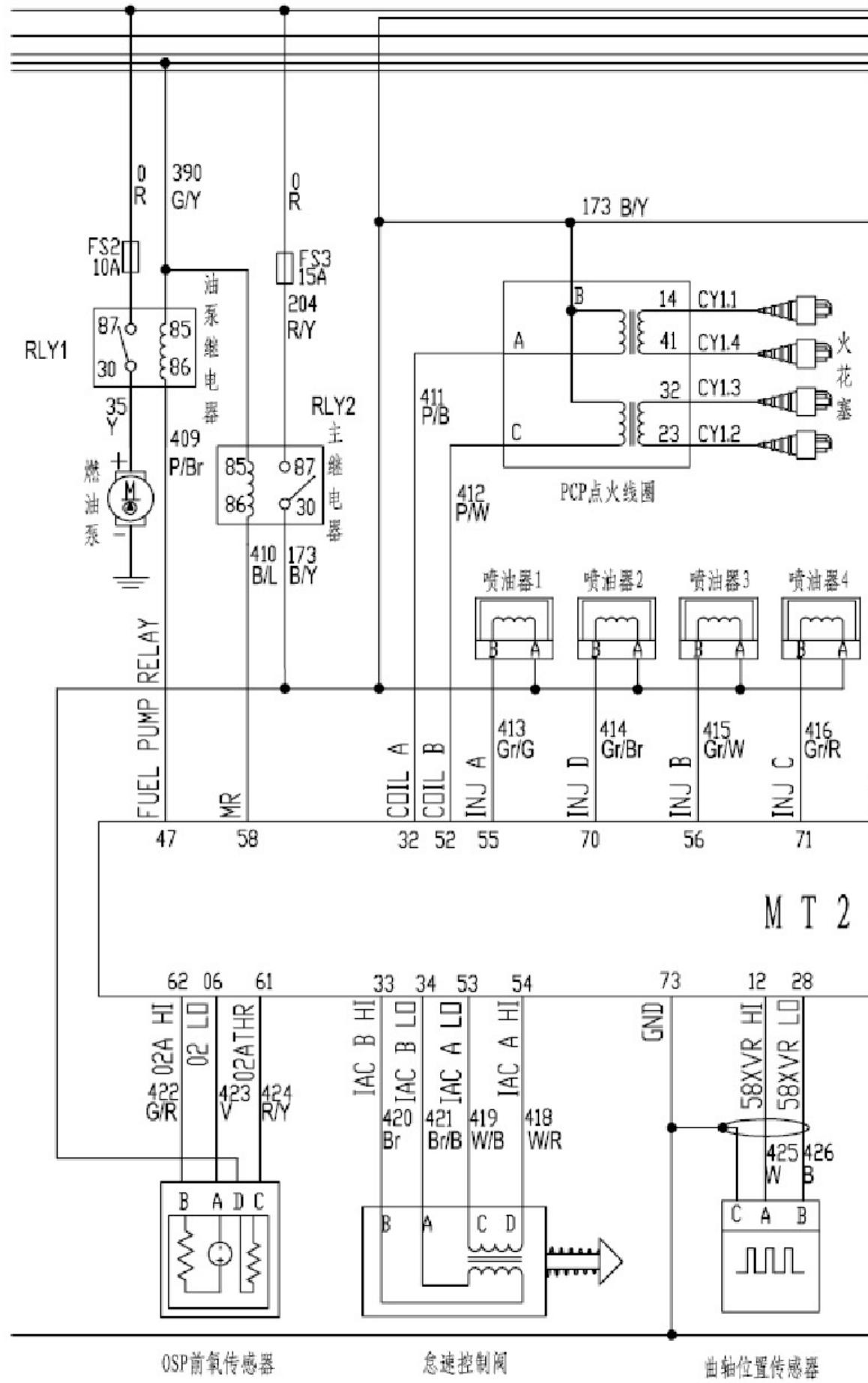

OSP前氧传感器

怠速控制阀

曲轴位置传感器

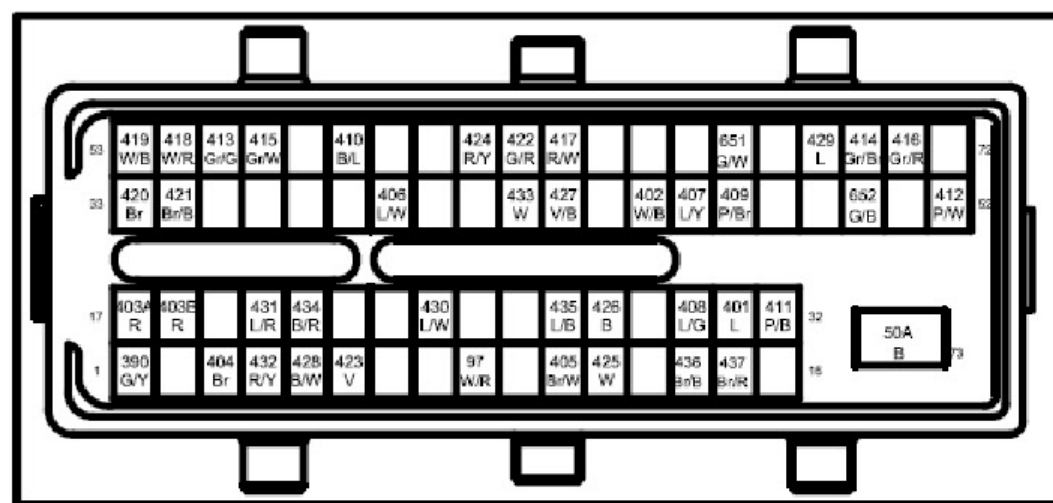

接ECM

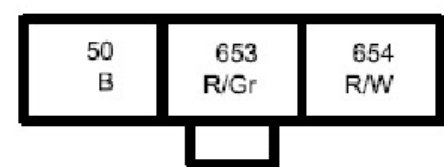

散热器风扇



接碳罐控制阀

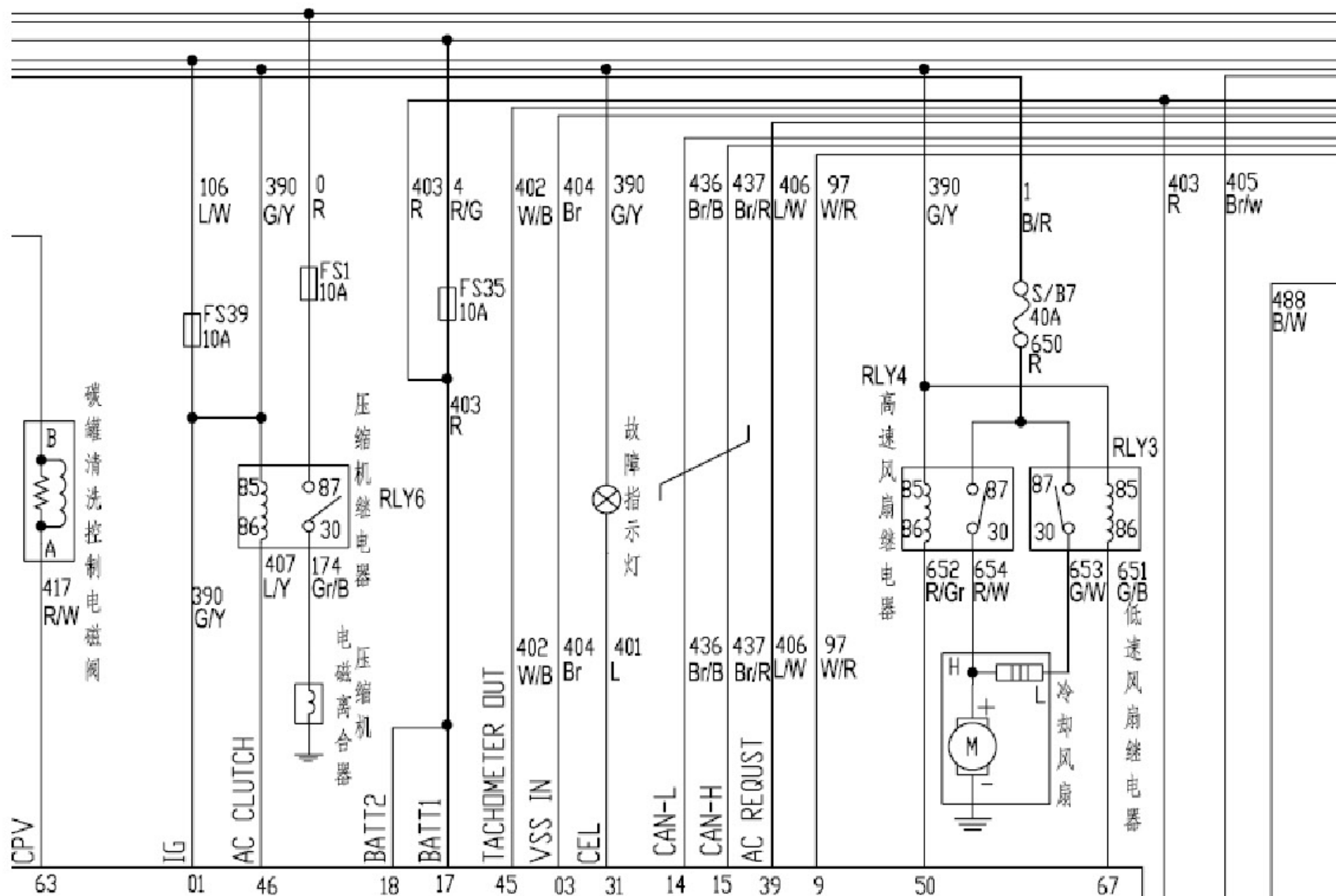

0 U (d e l p h i)

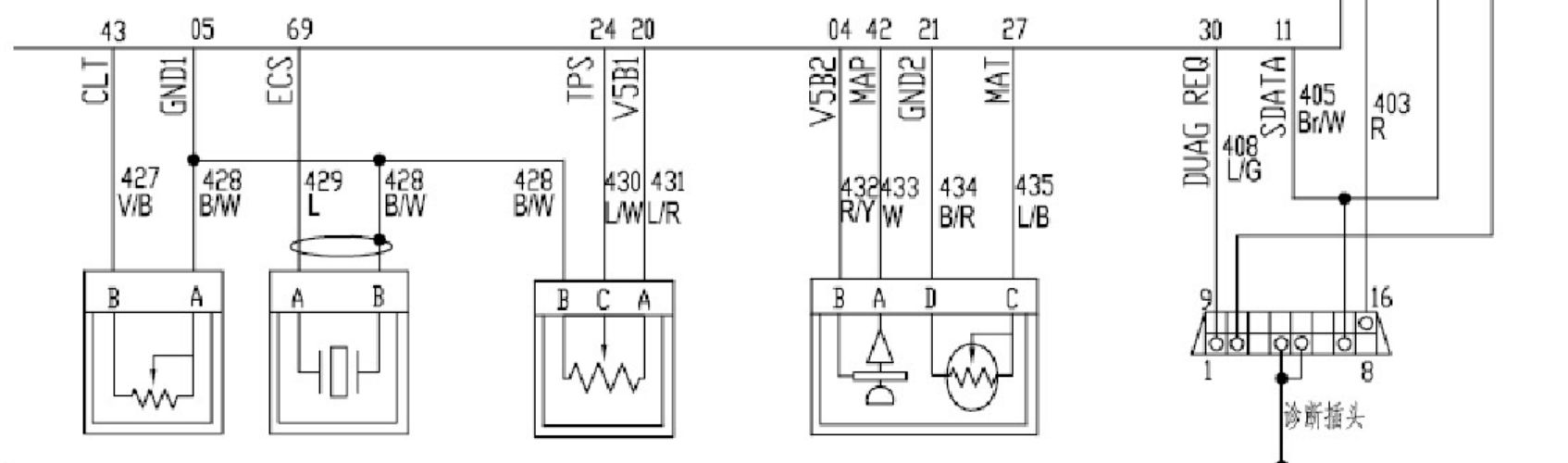

冷却液温度传感器

爆震传感器

节气门位置传感器

进气歧管压力温度传感器



接1号喷嘴(兰)

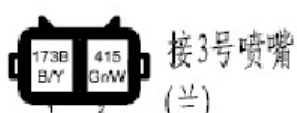

接3号喷嘴(兰)



接前氧传感器



接点火线圈



接2号喷嘴



接4号喷嘴



水温传感器



爆振传感器

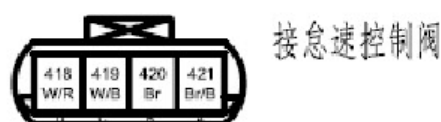

接怠速控制阀



节气门位置传感器



接进气温度压力传感器



油泵