

2.9 门灯及仪表系统

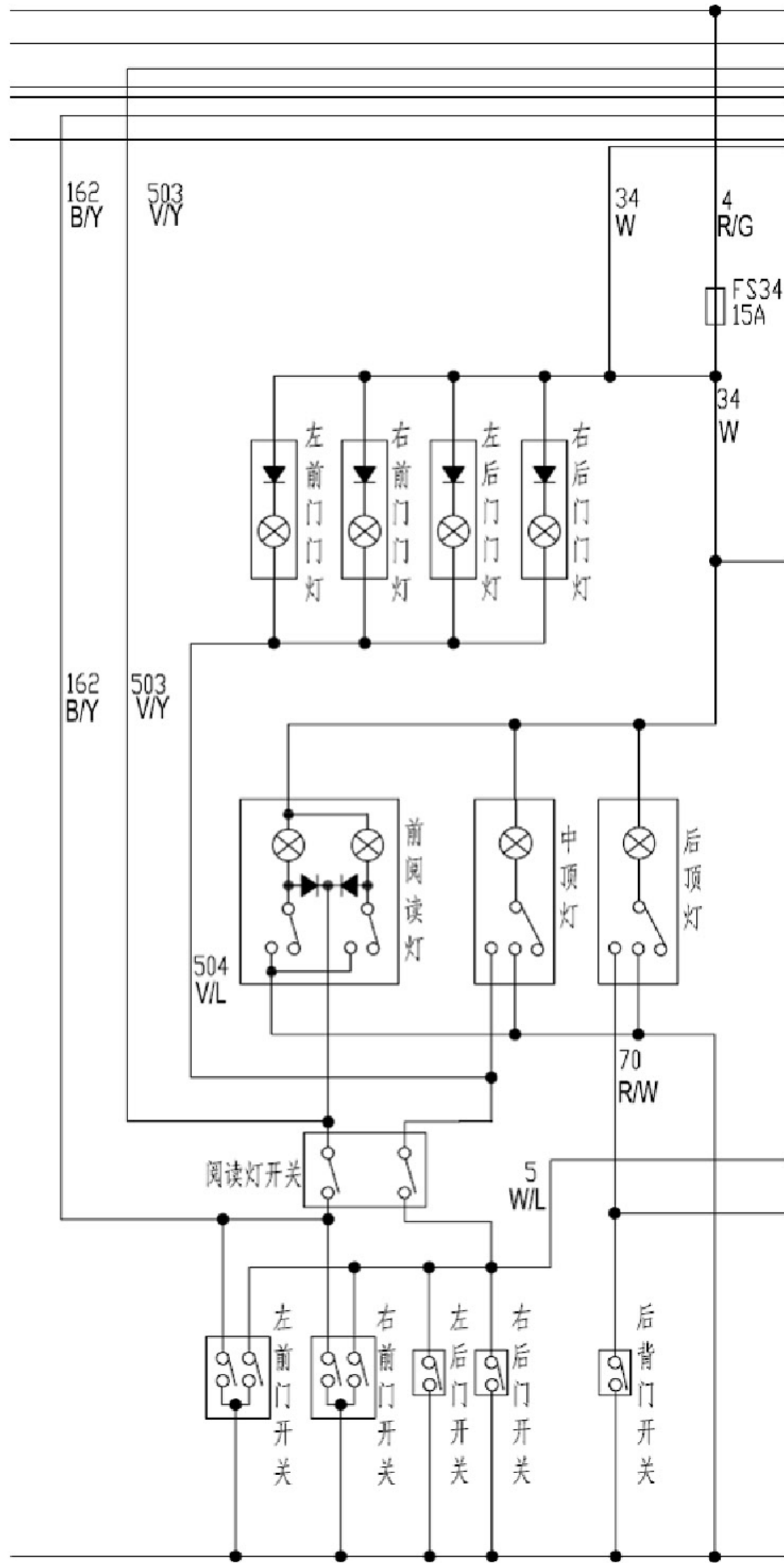

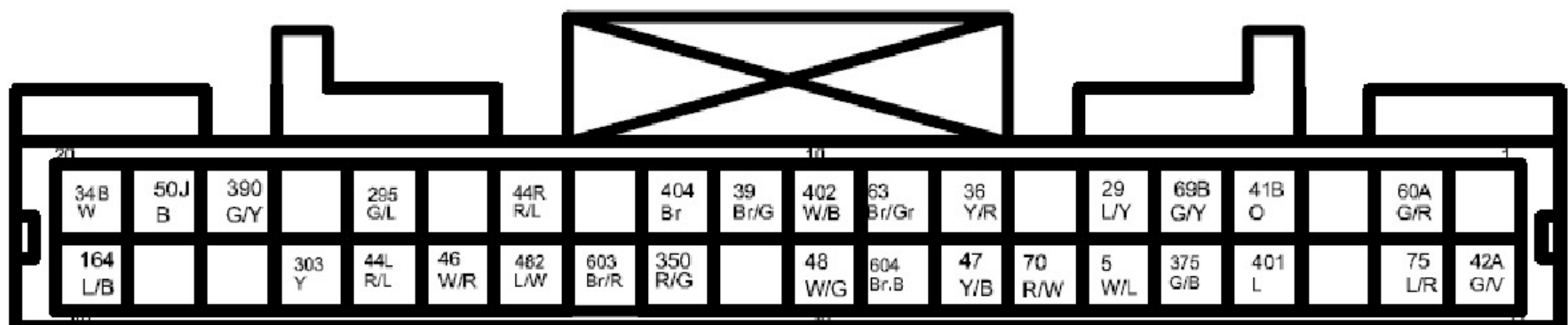

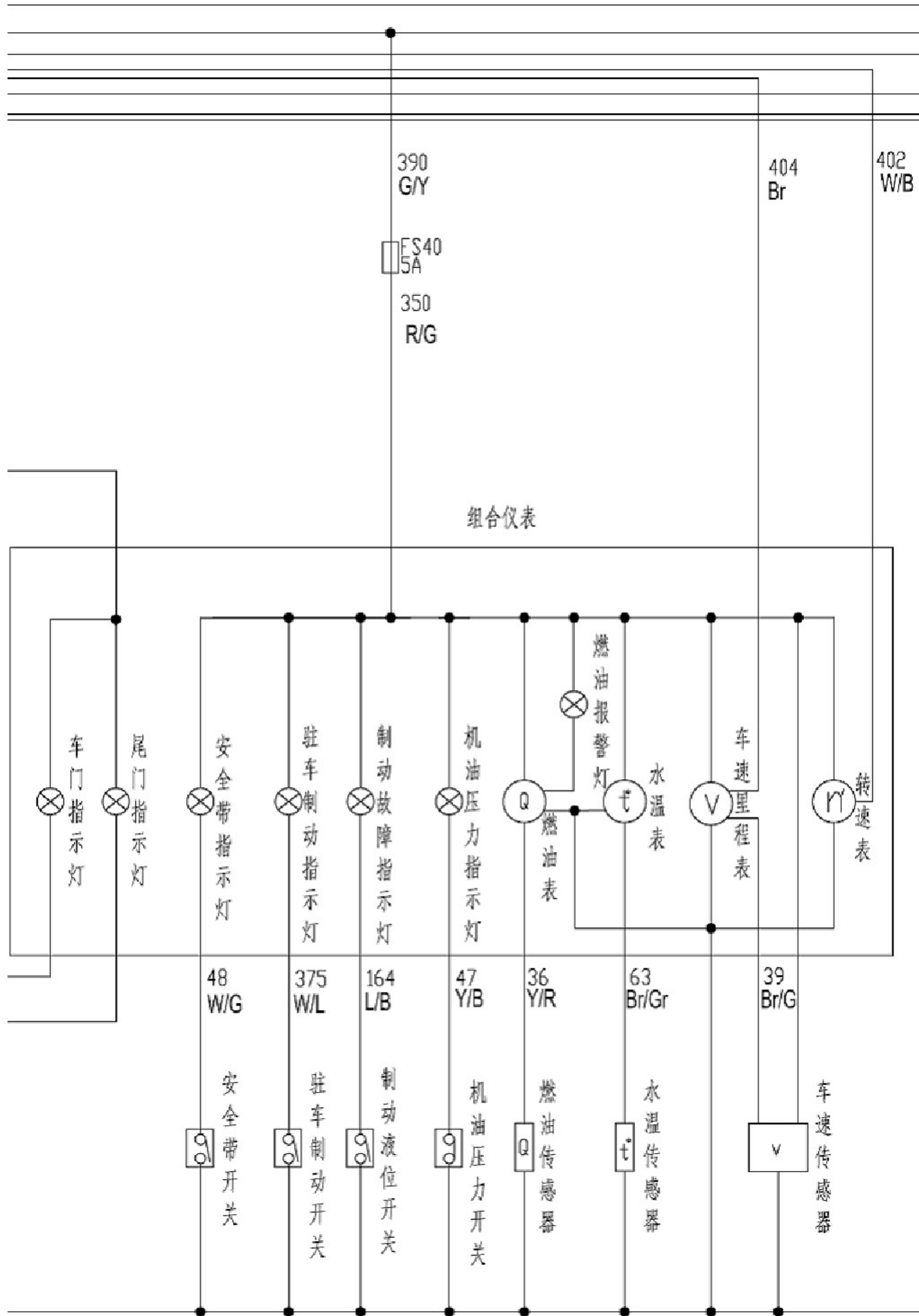
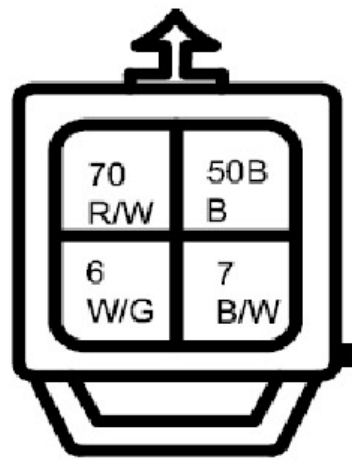

尾门一体化门锁总成(闭锁器)

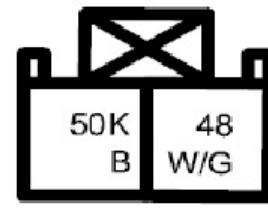

安全带开关



接手刹车

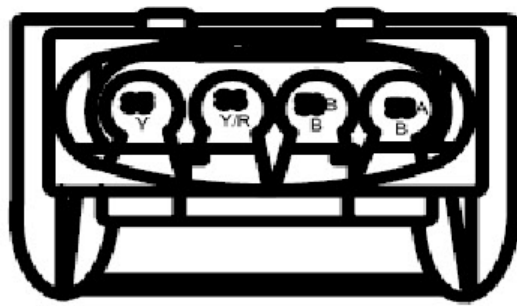

油泵

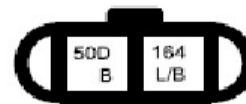

制动液面报警

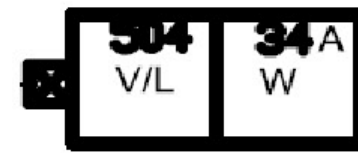

中顶灯

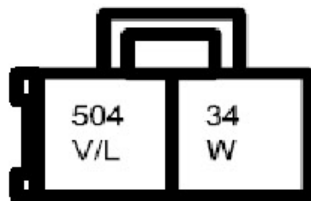

门灯

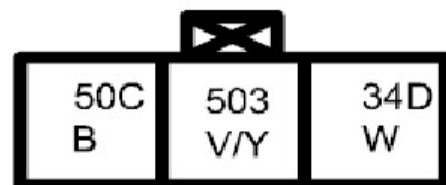

前顶灯

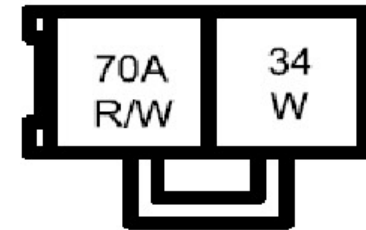

后顶灯

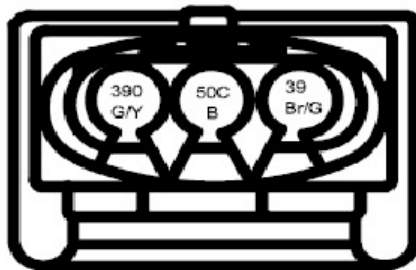

车速里程传感器

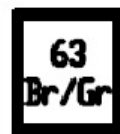

水温塞



机油压力传感器

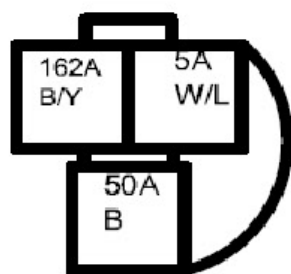

接左前门灯开关

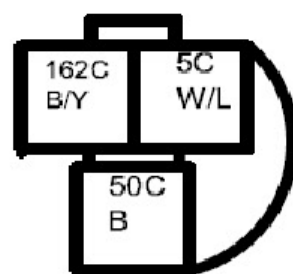

接右前门灯开关



接左后门灯开关



接右后灯开关