

26. 分线点第一节

63/5

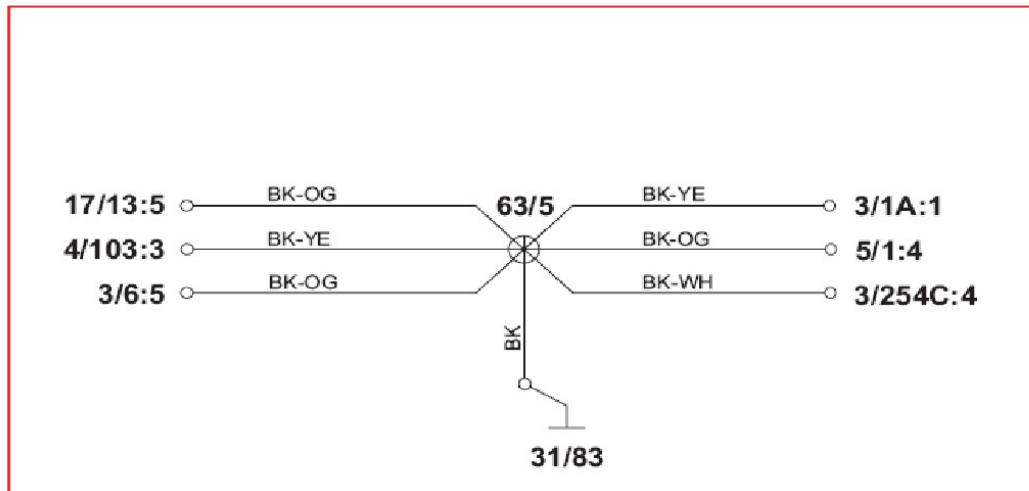

63/6

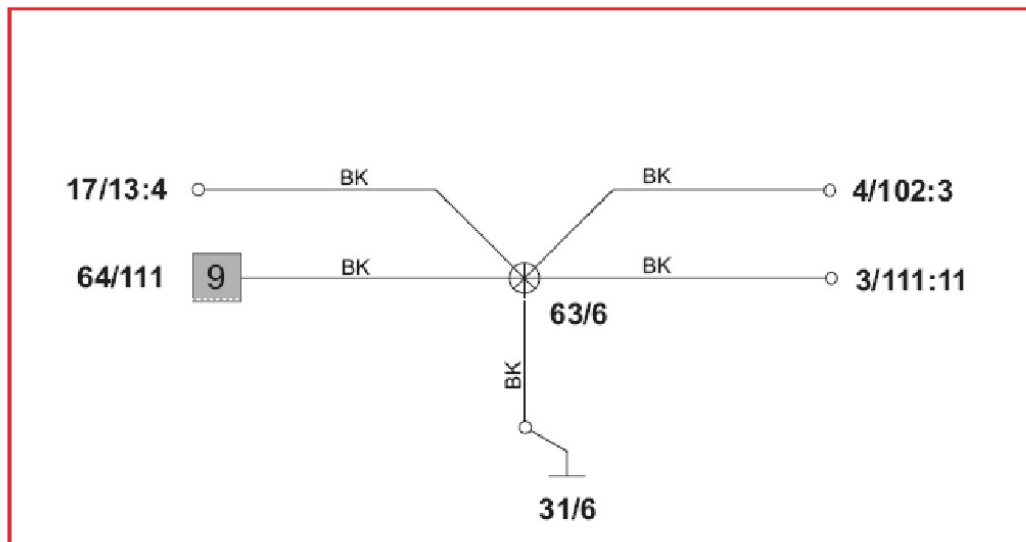

63/10

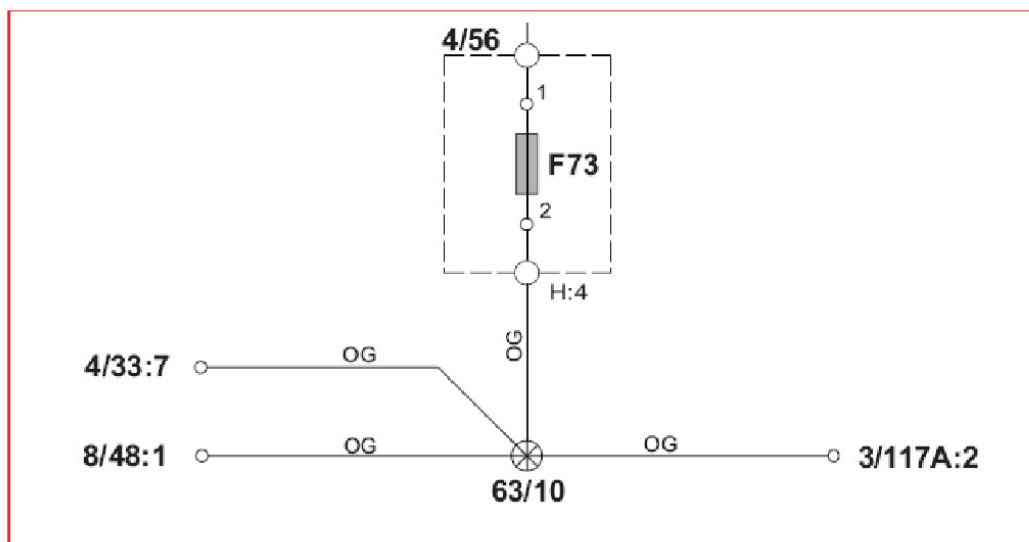

63/11

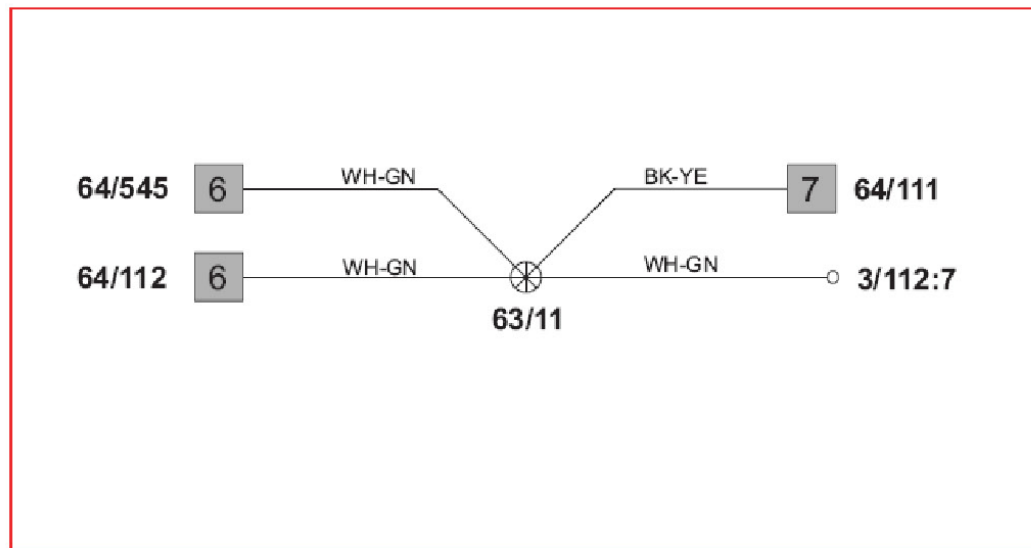

63/12

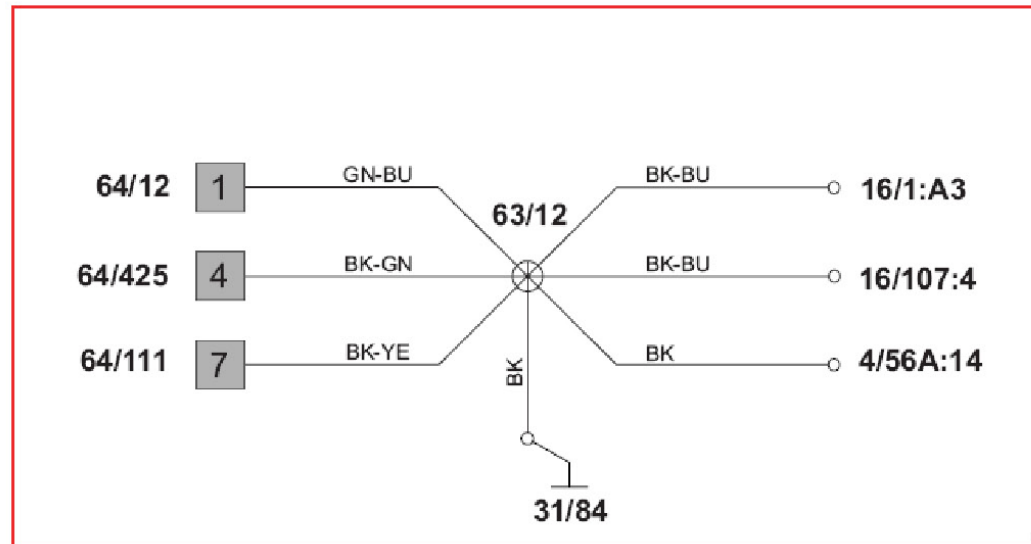

63/13

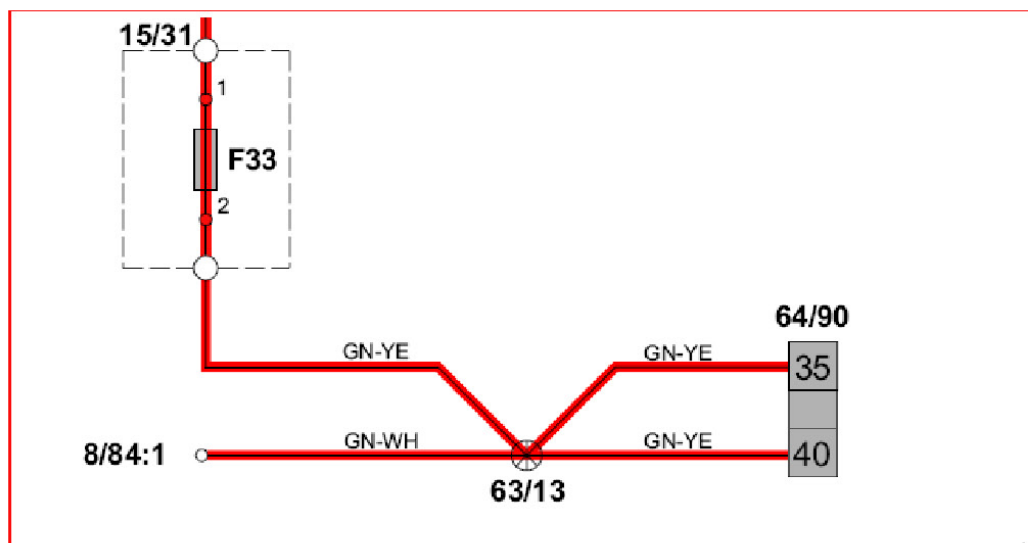

63/14

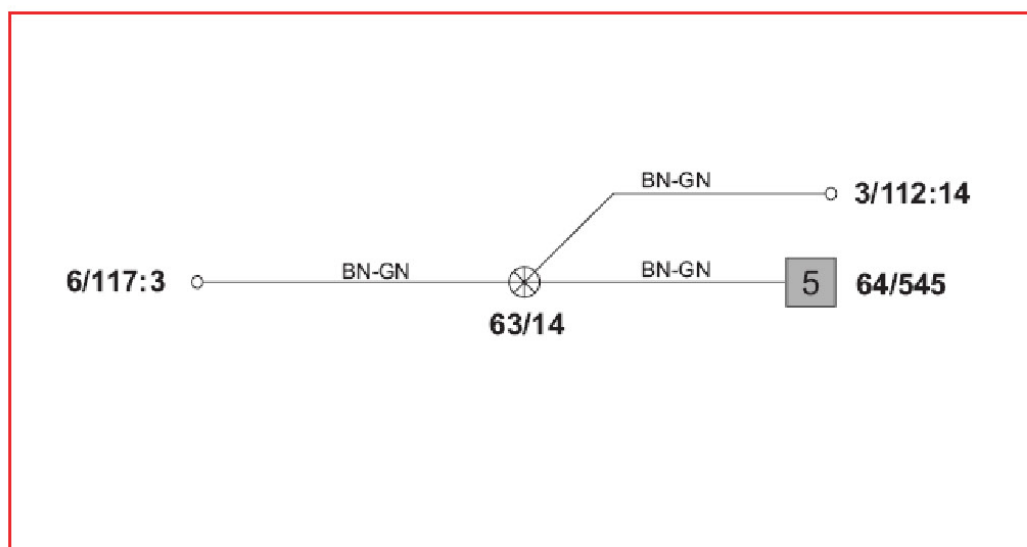

63/15

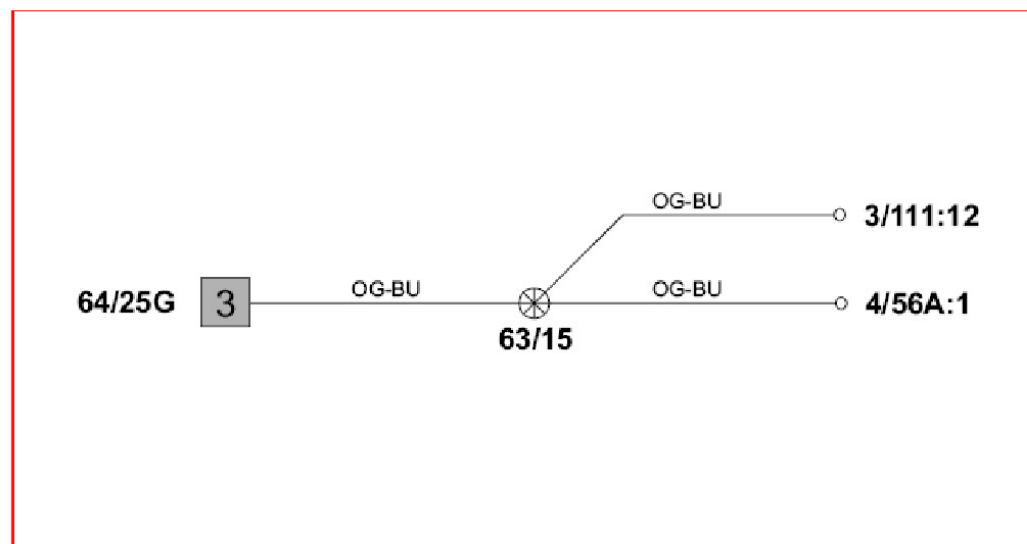

63/25

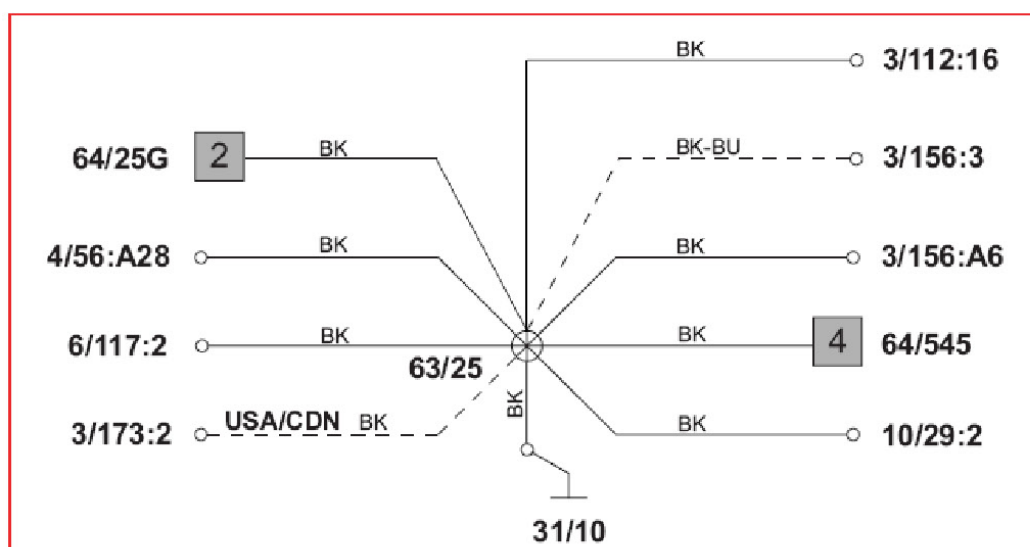

63/25G

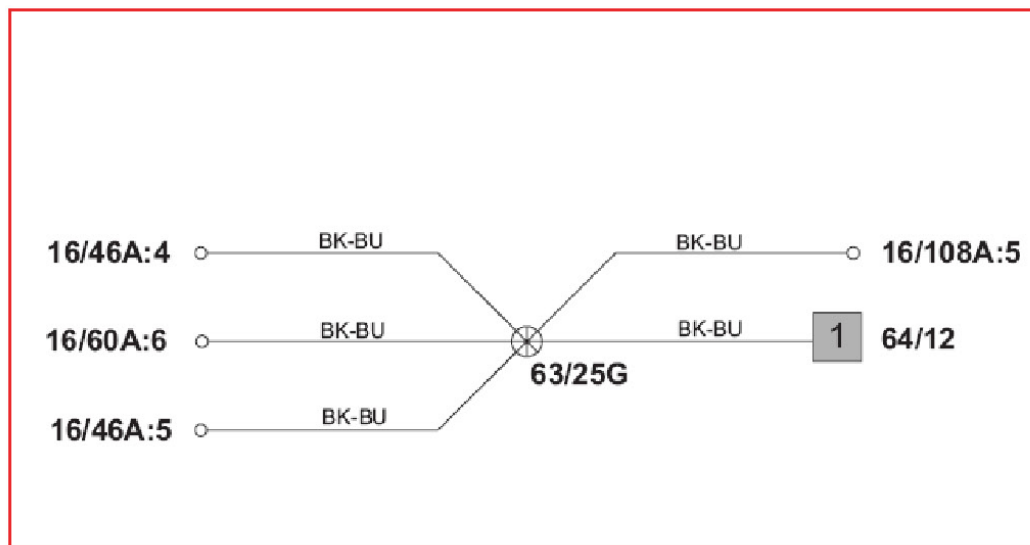

63/27

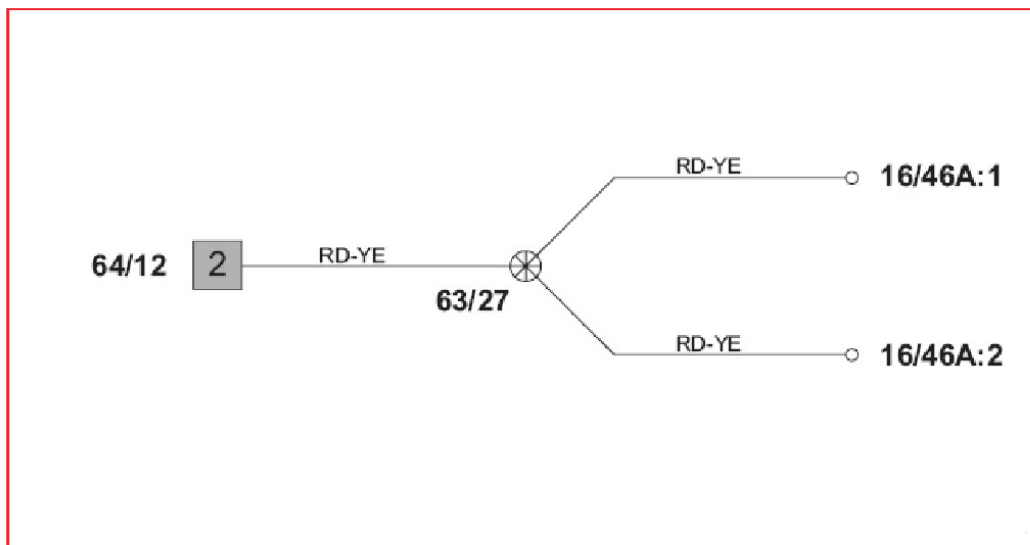

63/28

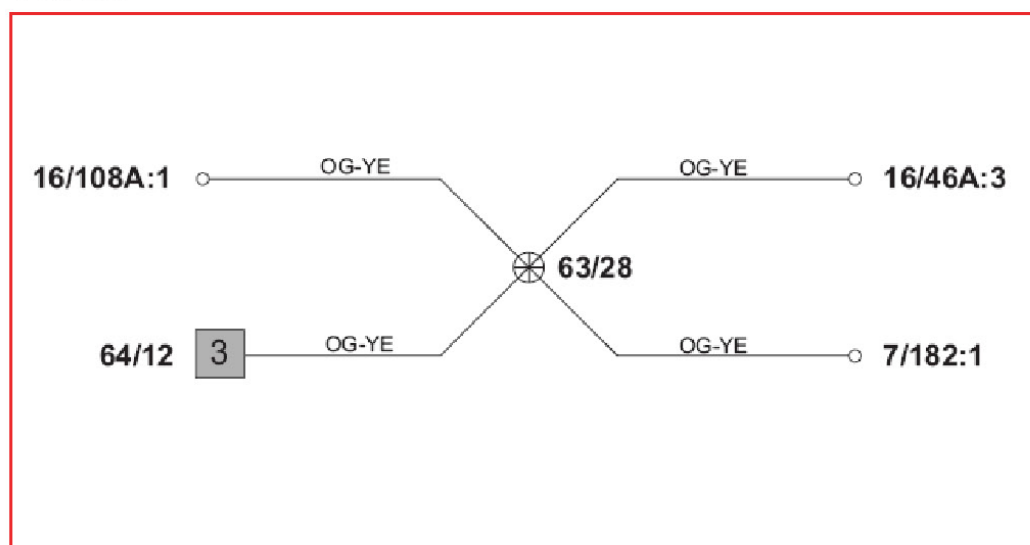

63/29

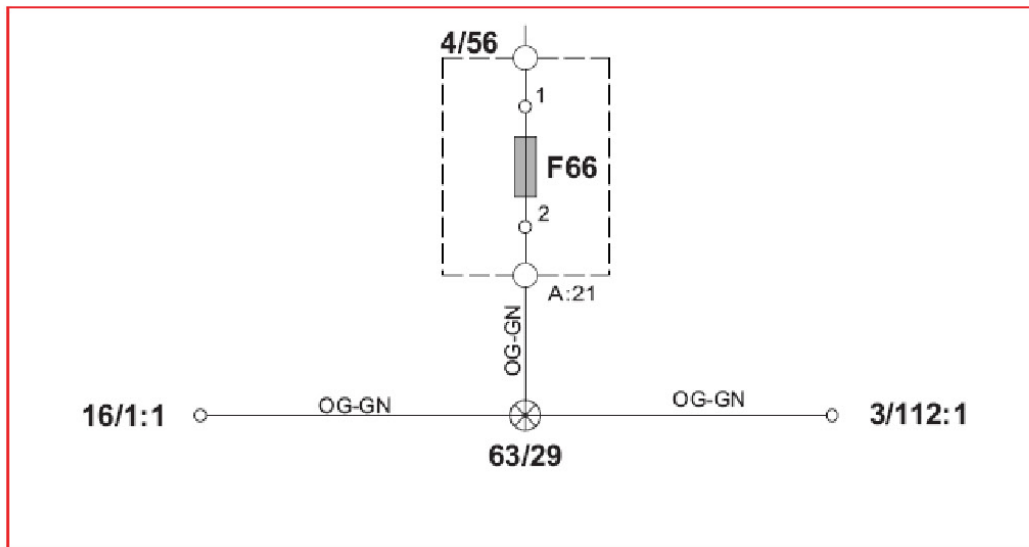

63/29G

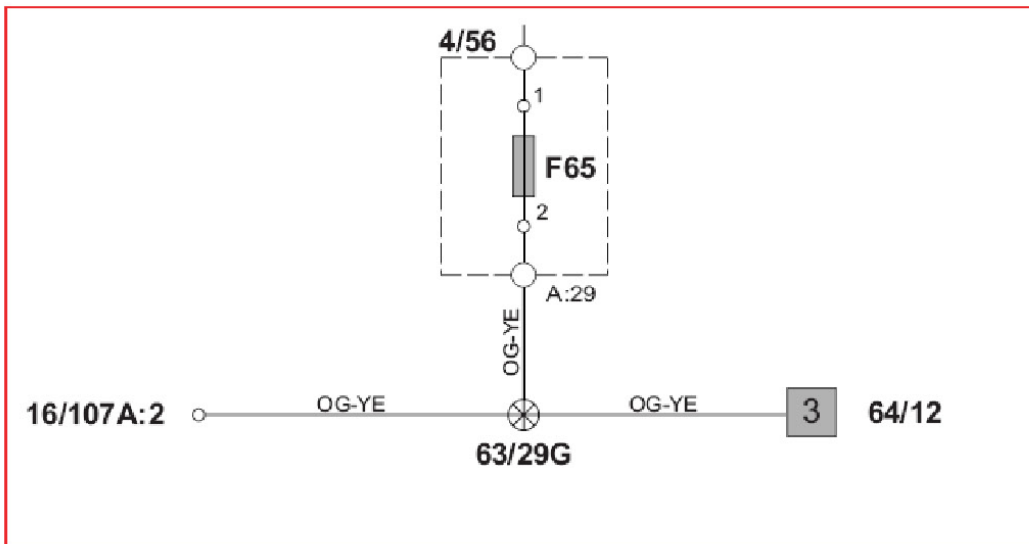

63/30

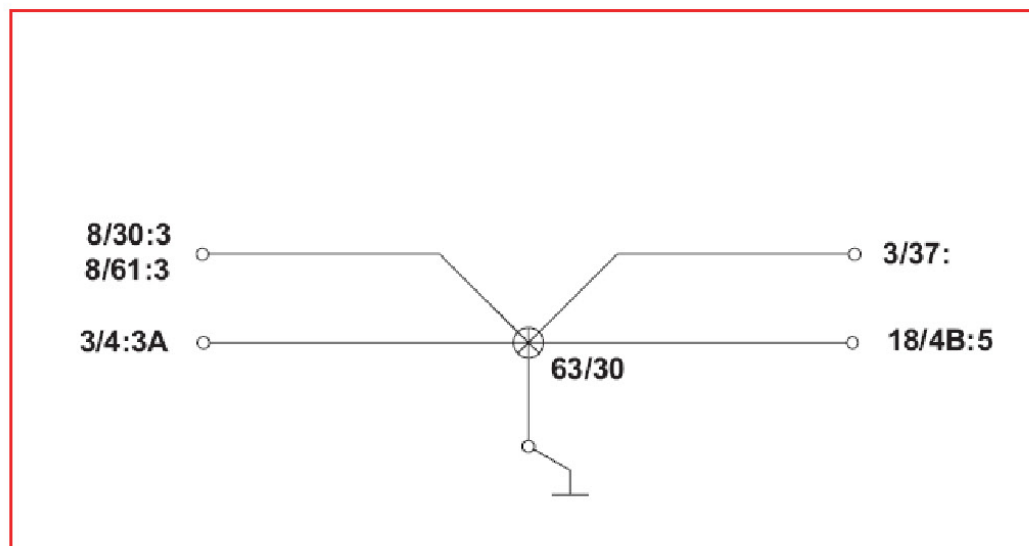

63/53 汽油

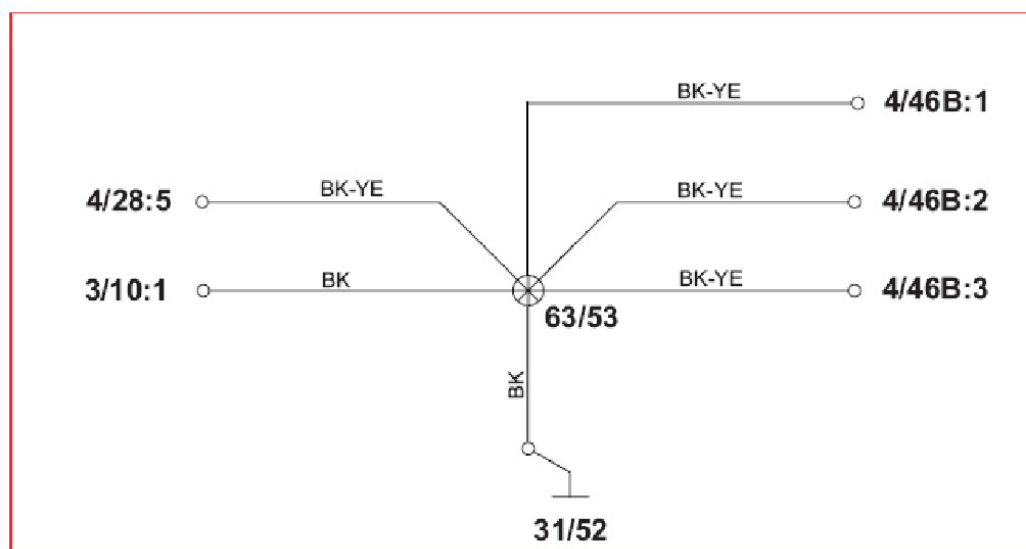

63/53 柴油

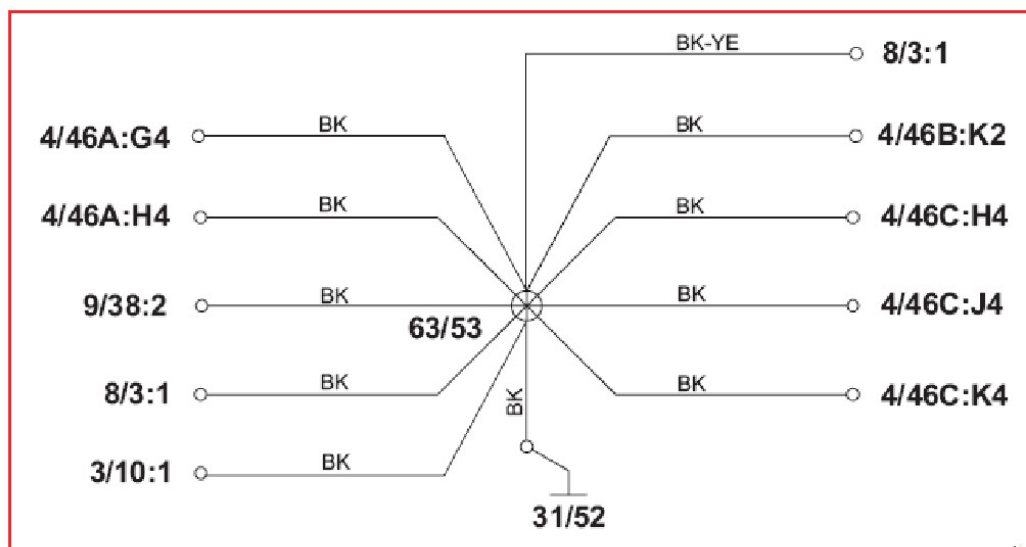

63/54

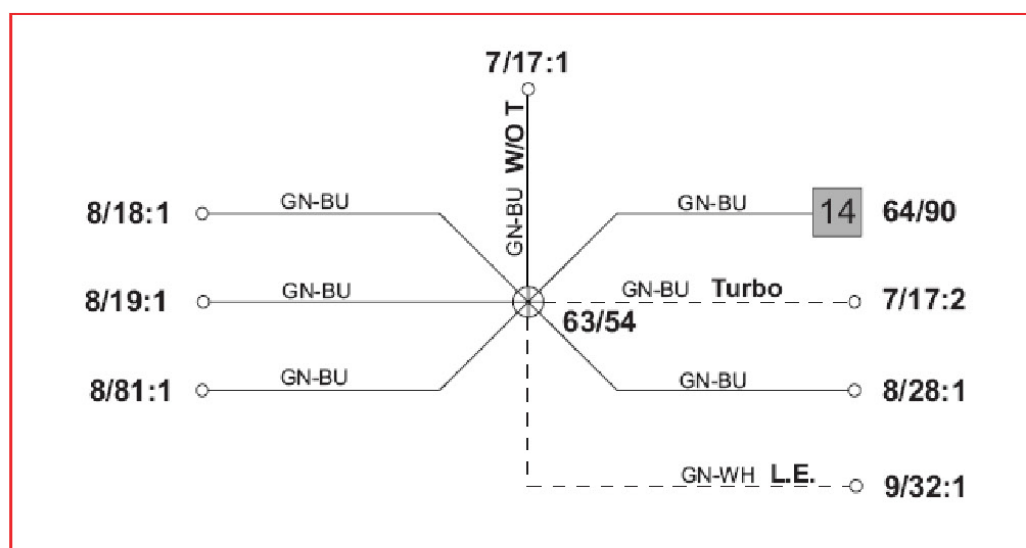

63/56

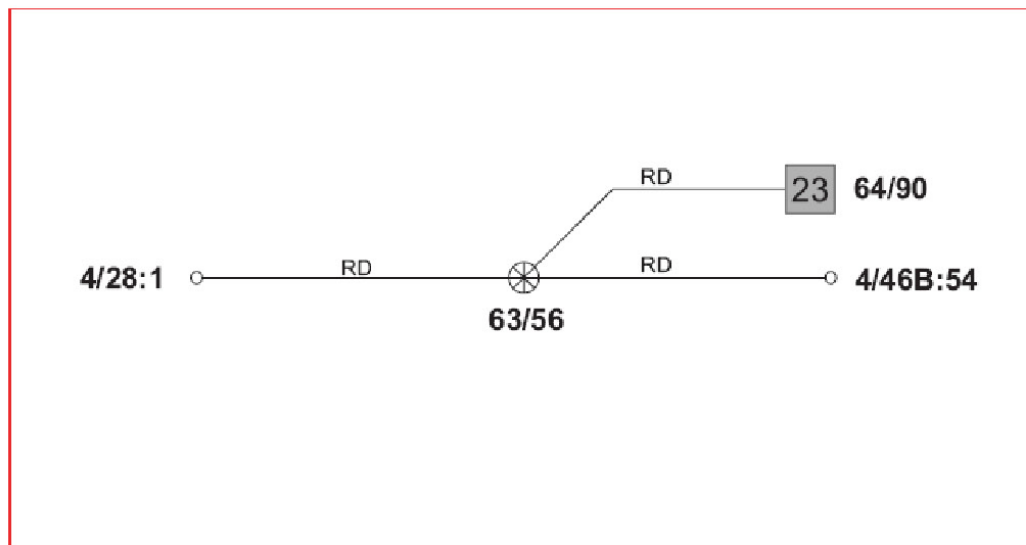

63/61

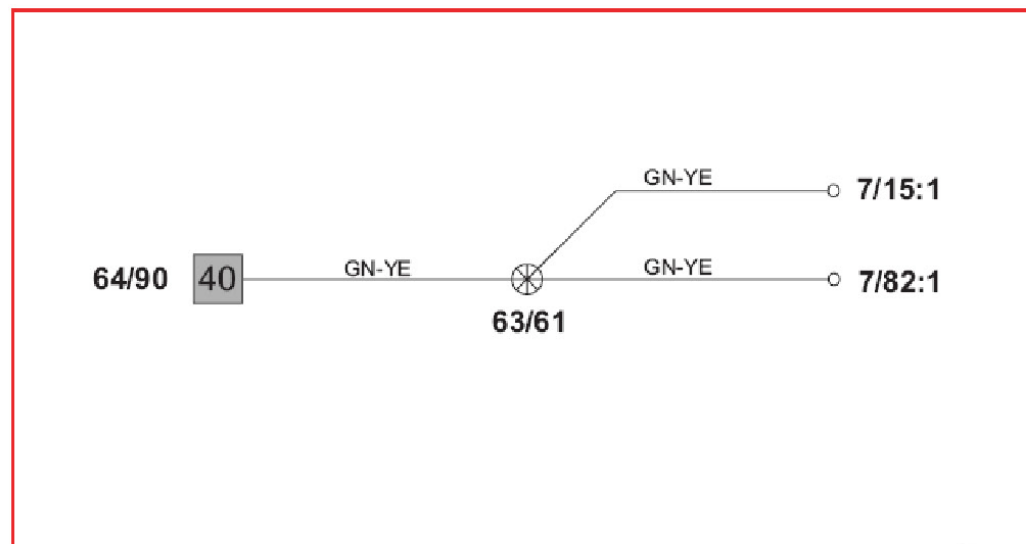

63/65

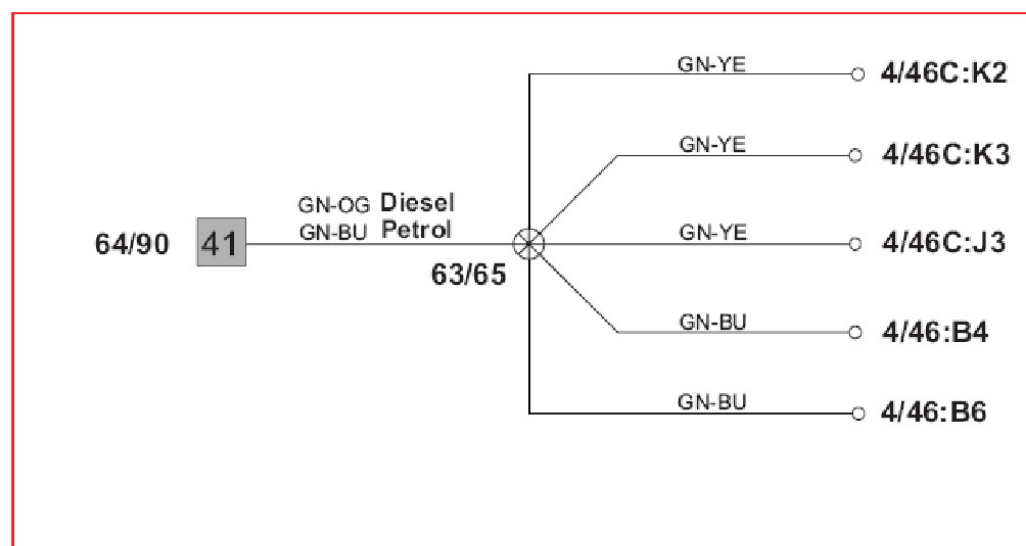

63/83

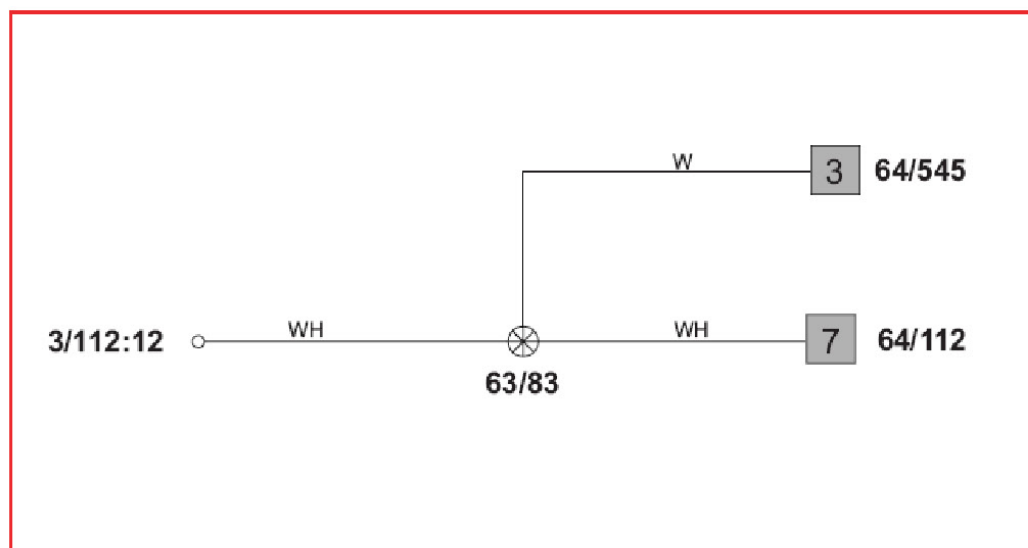

63/86

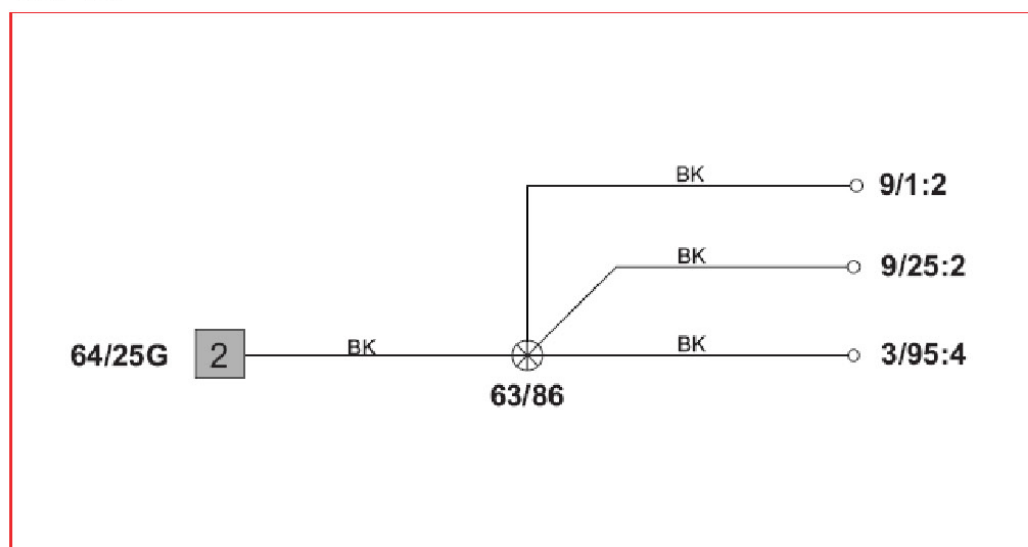

63/87

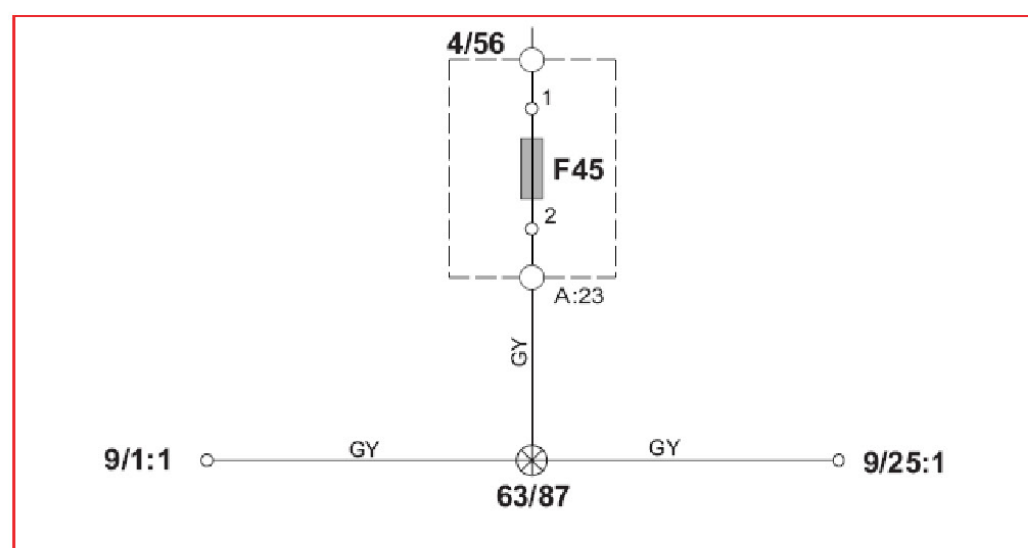

63/89

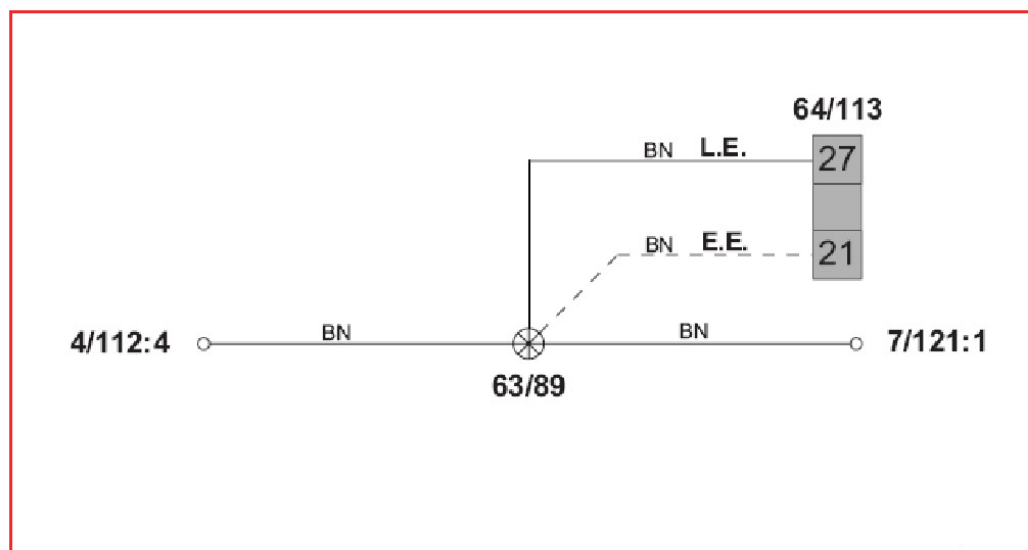

63/90

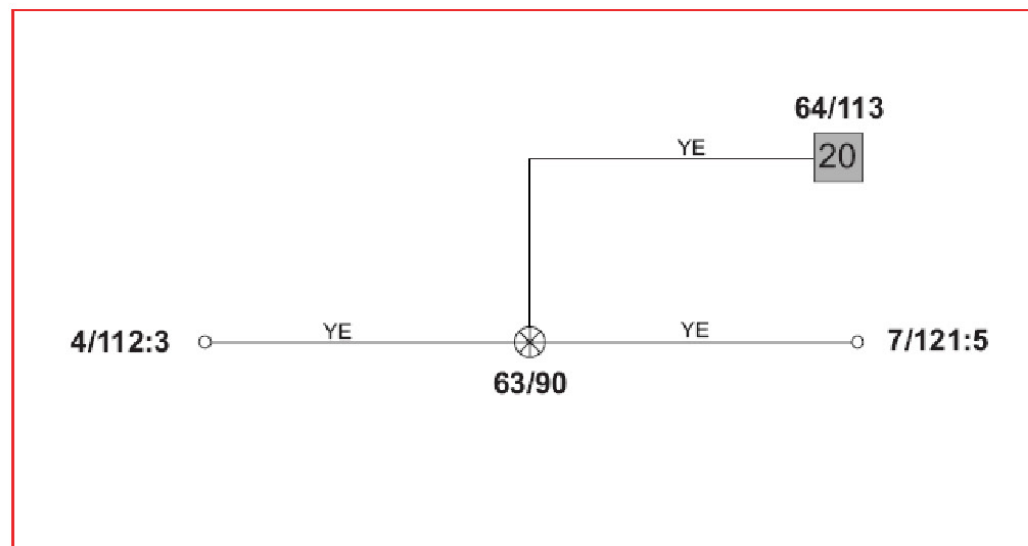

63/91

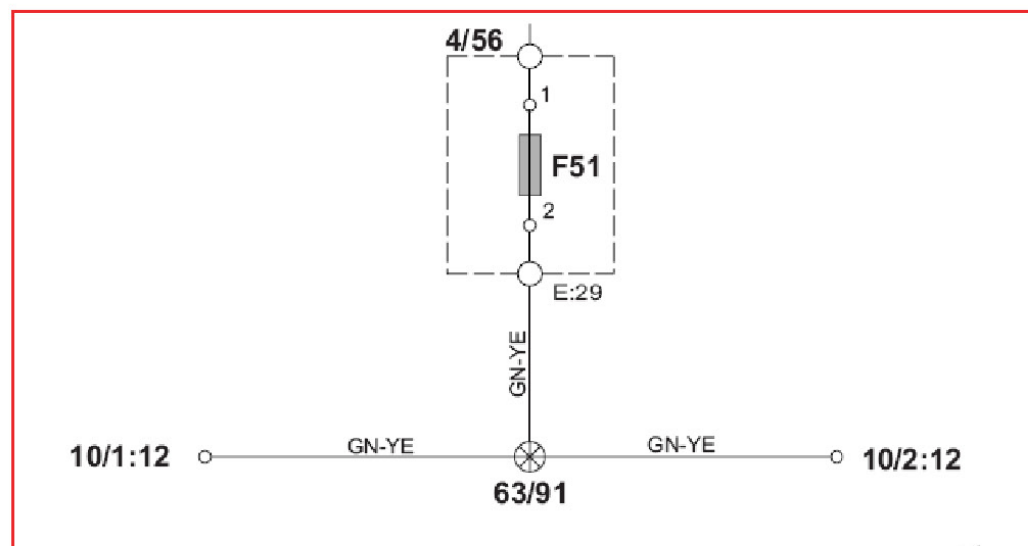

63/91G

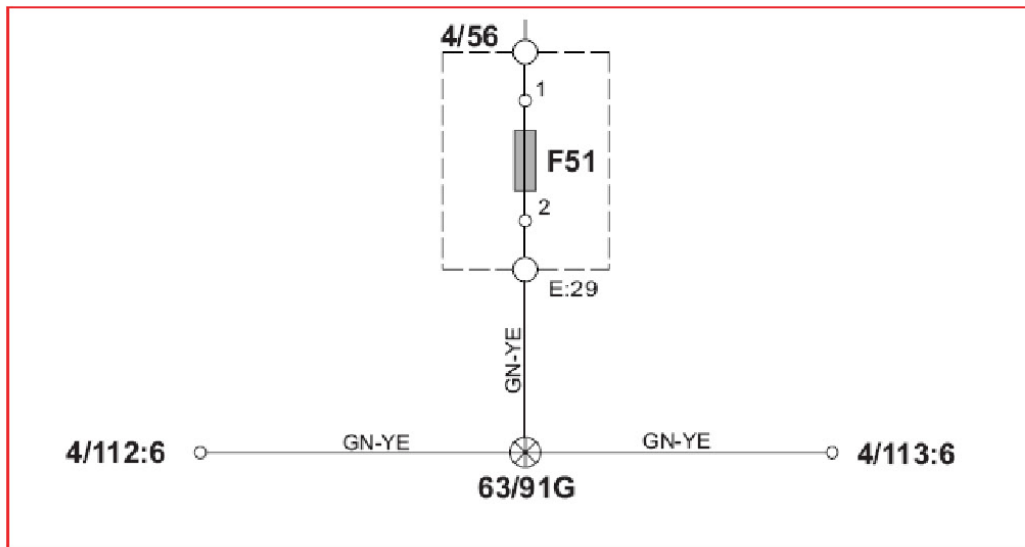

63/92

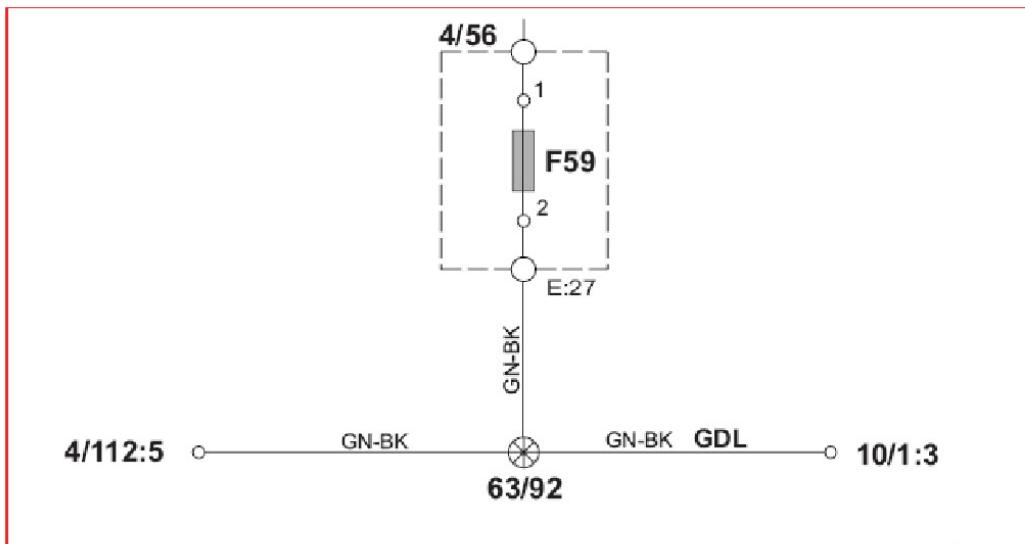

63/93

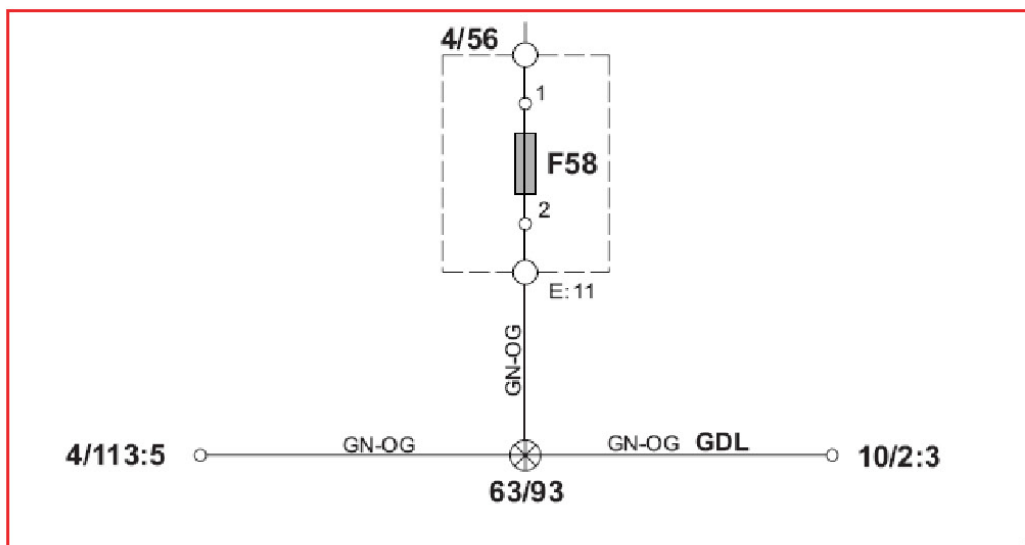

63/97 汽油，無渦輪

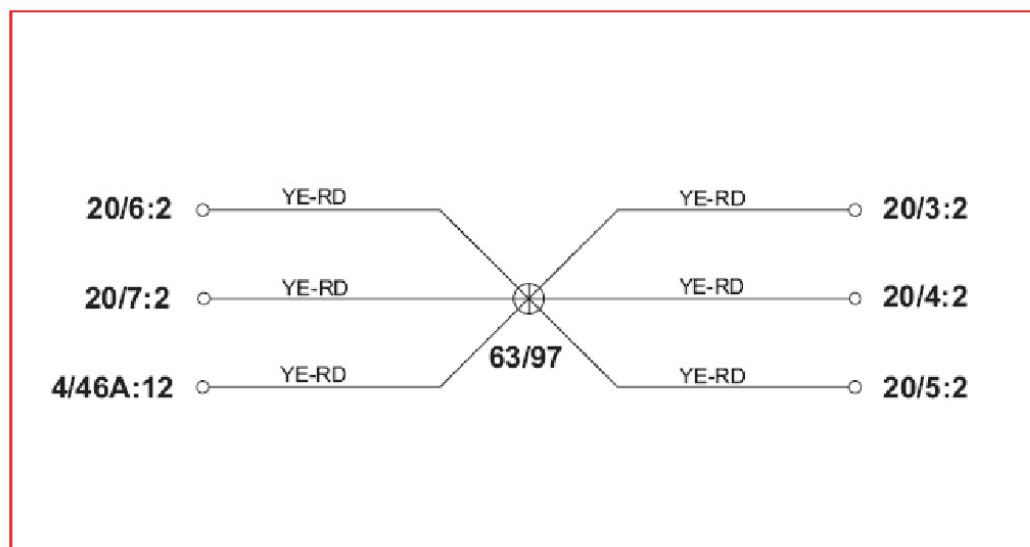

63/98 汽油

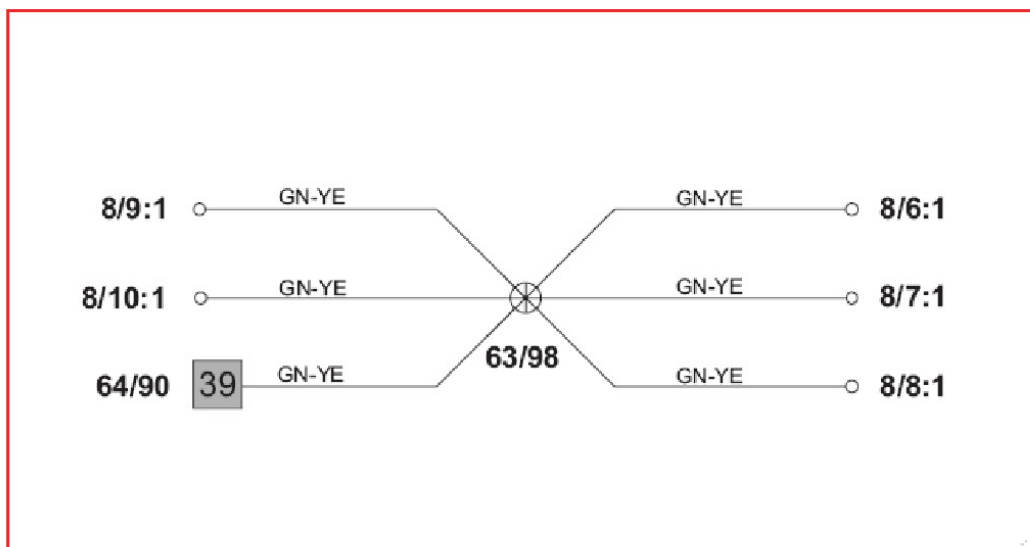

63/103 汽油

