

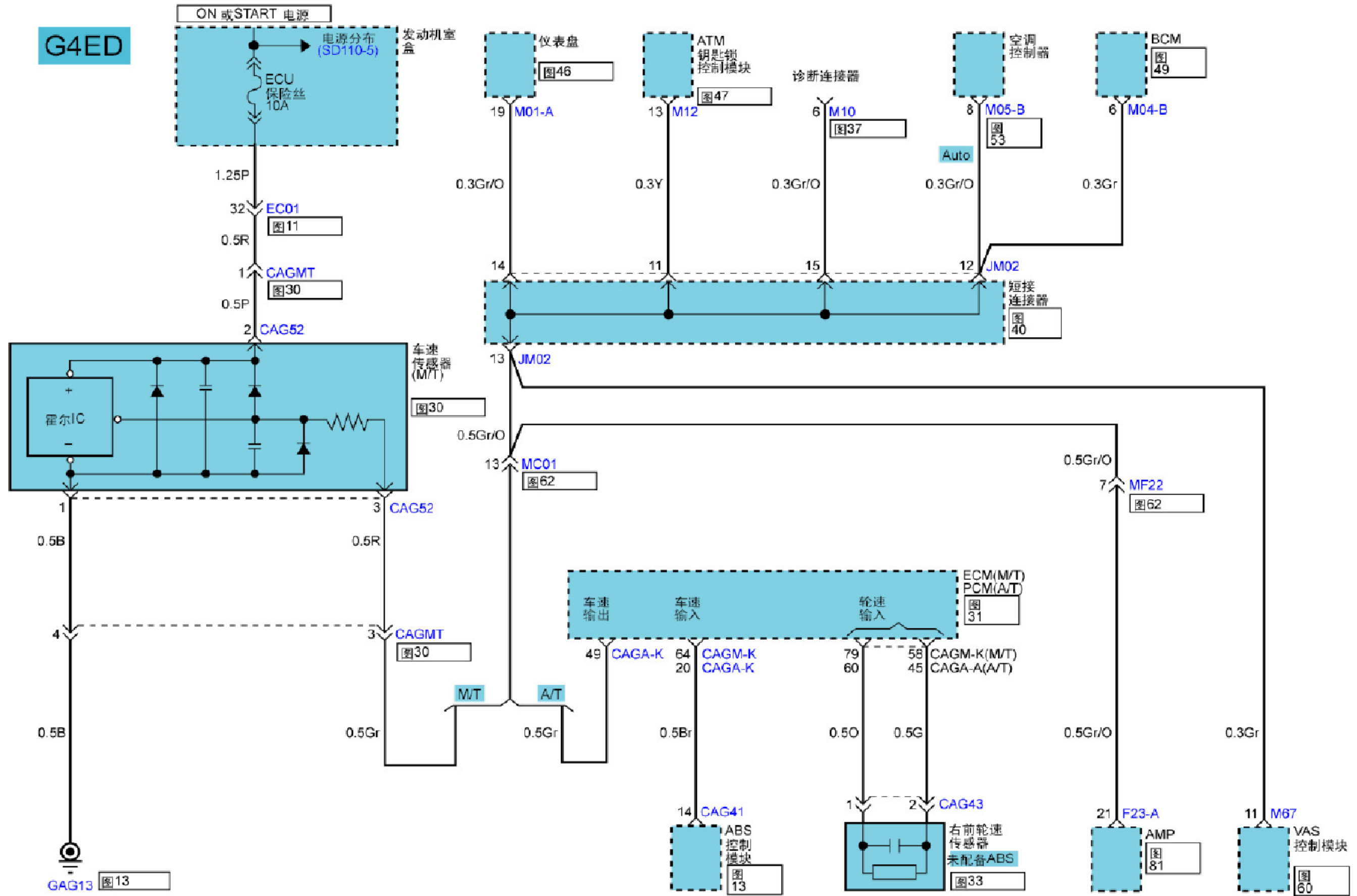

2.6 车速系统

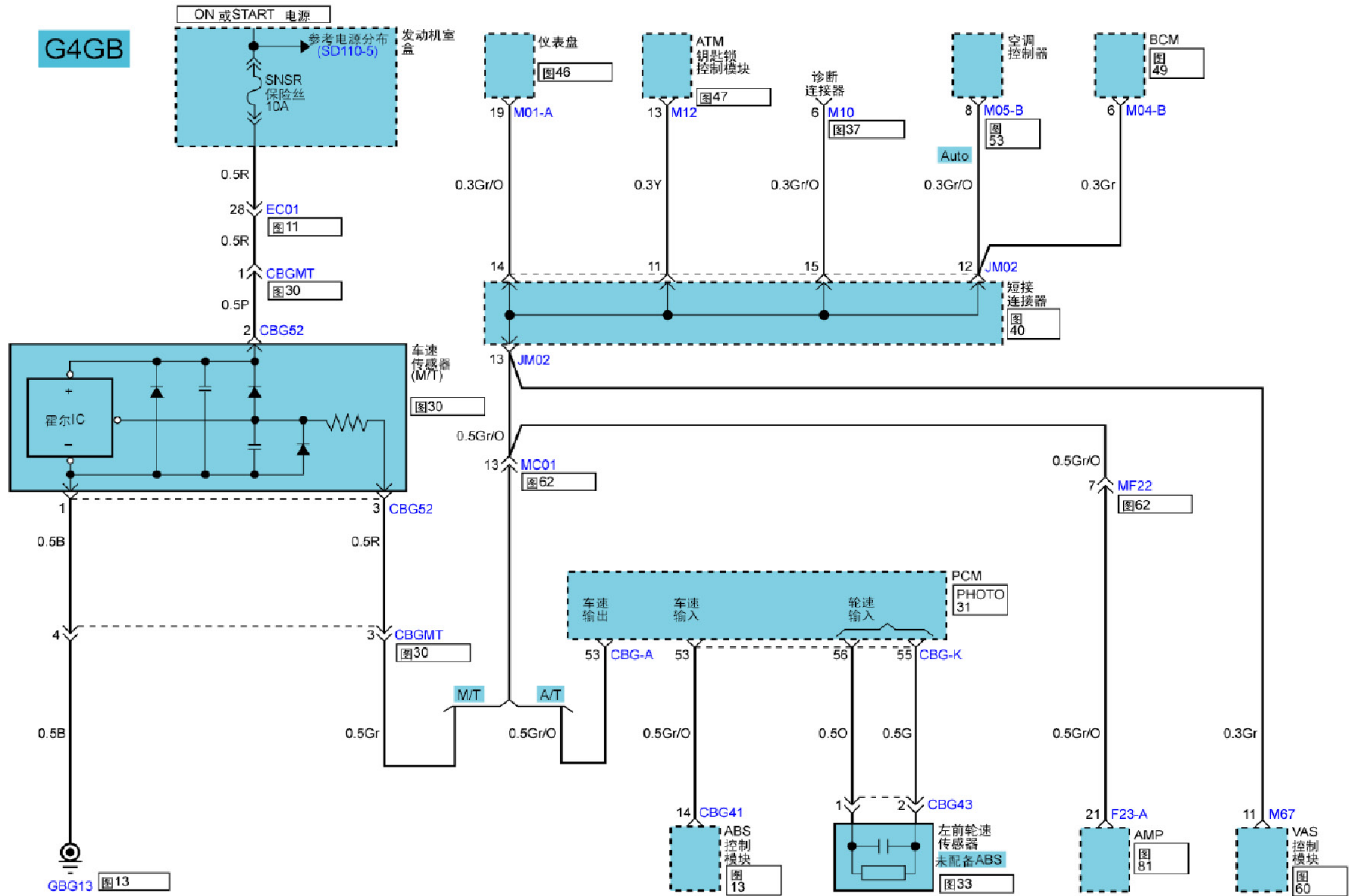

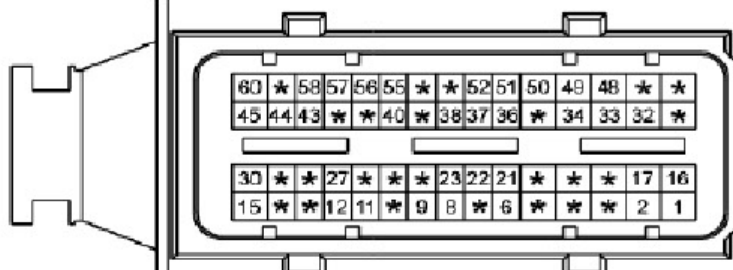
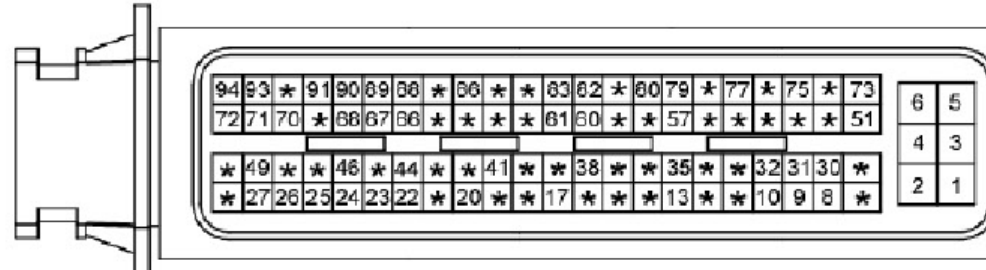
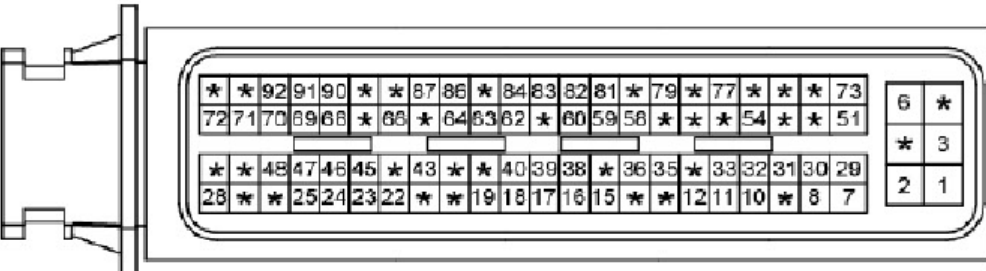
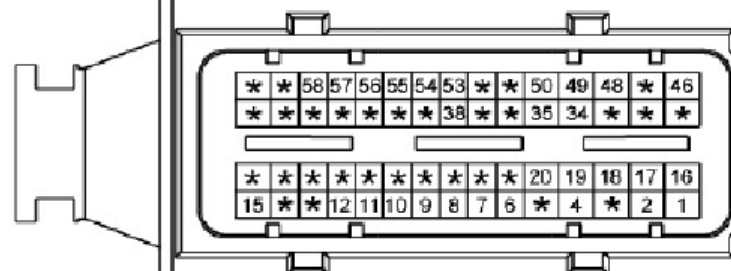
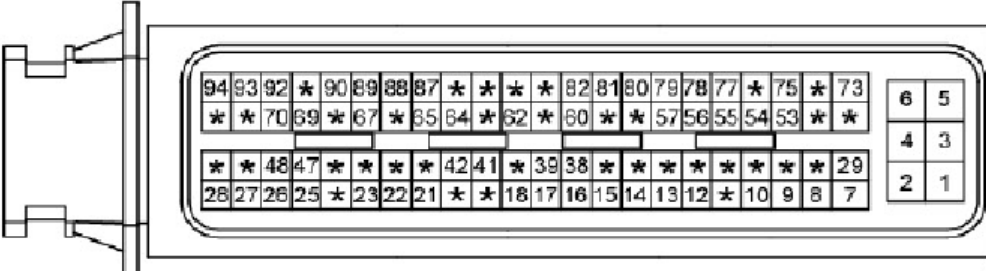
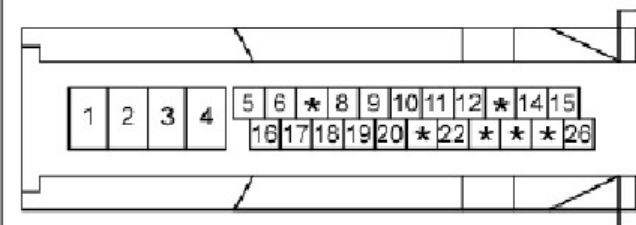

车速系统连接器介绍

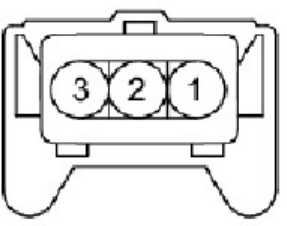
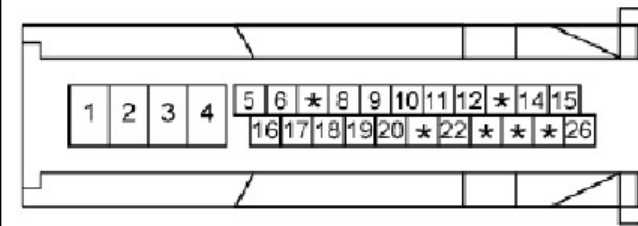
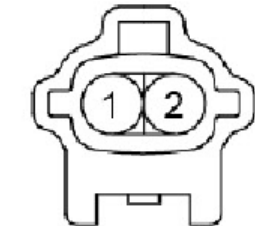
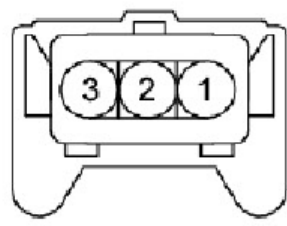
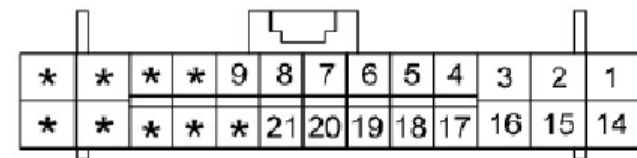
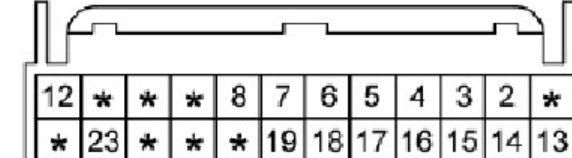
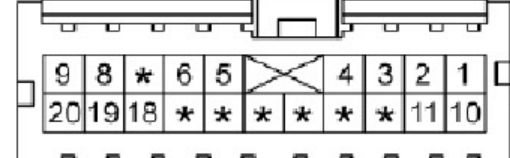
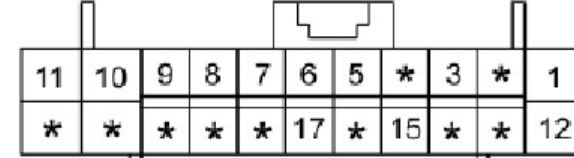
<p>CAGA-A</p>  <p>AMP_ECU_60F_B</p>	<p>CAGA-K</p>  <p>AMP_ECU_94F_B</p>		
<p>CAGM-K</p>  <p>AMP_ECU_94F_B</p>	<p>CBG-A</p>  <p>AMP_ECU_60F_B</p>		
<p>CBG-K</p>  <p>AMP_ECU_94F_B</p>	<p>CAG41</p>  <p>BOS_ABS_26F_B_L</p>	<p>CAG43</p>  <p>KET_090IIVP_02M_Gr</p>	
<p>CAG52</p>  <p>AMP_JPT_03F_B_S1</p>	<p>CBG41</p>  <p>BOS_ABS_26F_B_L</p>	<p>CBG43</p>  <p>KET_090IIVP_02M_Gr</p>	<p>CBG52</p>  <p>AMP_JPT_03F_B_S1</p>
<p>F23-A</p>  <p>AMP_0407MII_26F_GY</p>	<p>M01-A</p>  <p>AMP_025_24F_W</p>	<p>M04-B</p>  <p>AMP_040III_20F_W</p>	<p>M05-B</p>  <p>AMP_0407_22F_W_HD</p>

车速系统连接器介绍

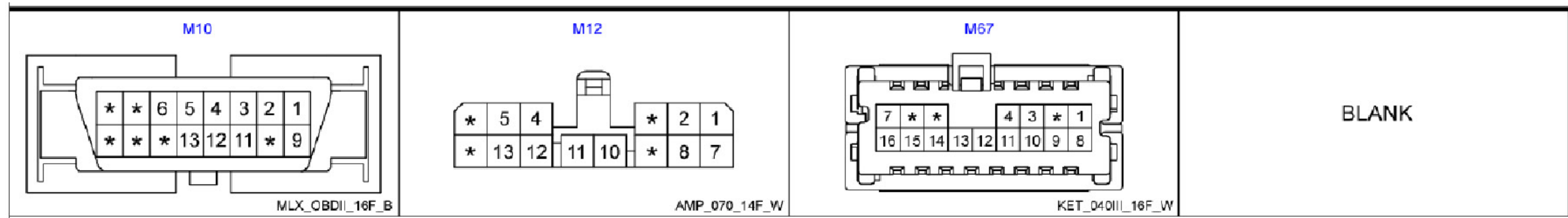

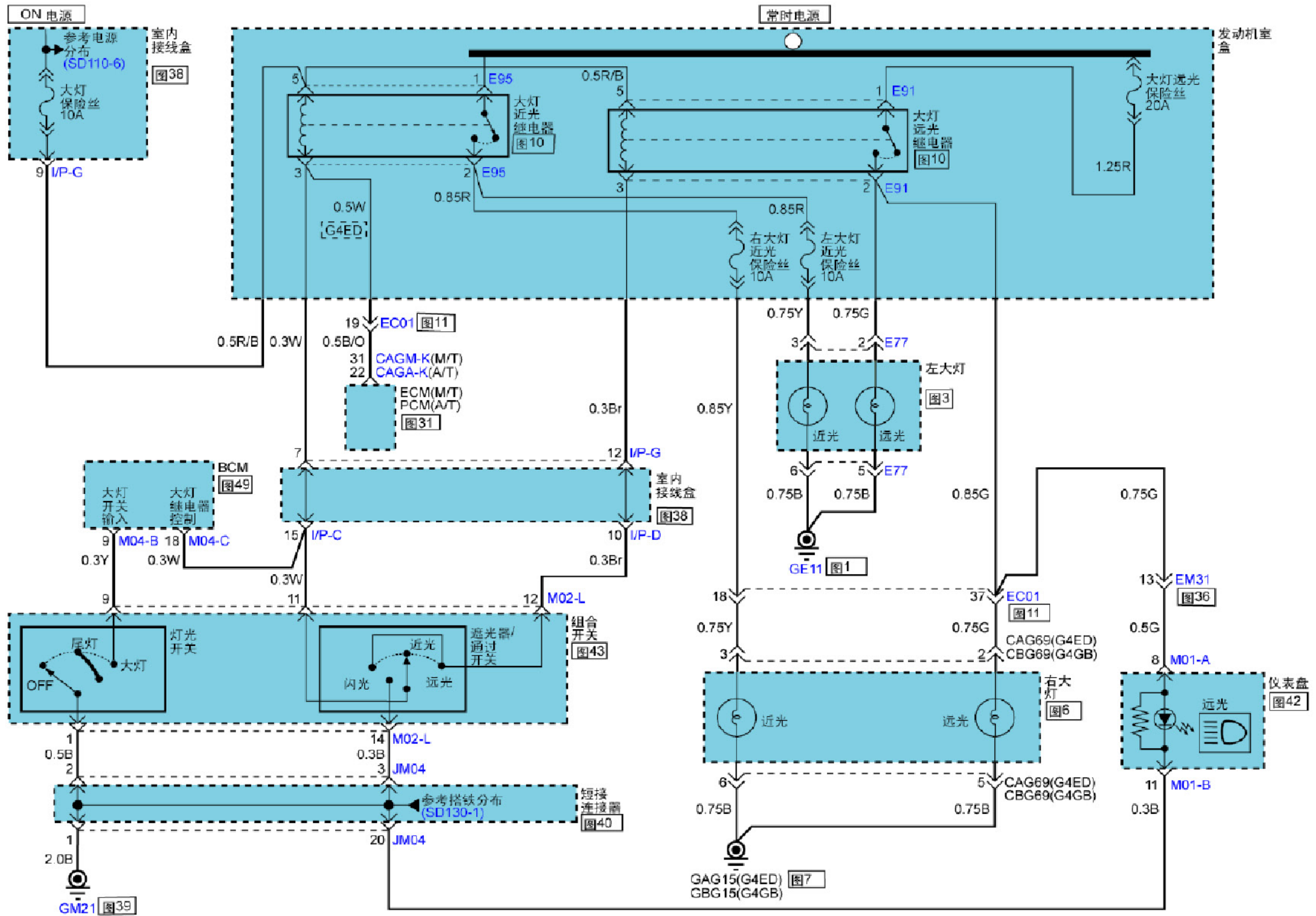

LAUNCH

2.7 大灯

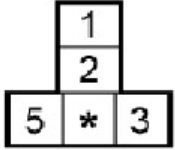
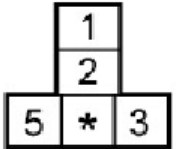
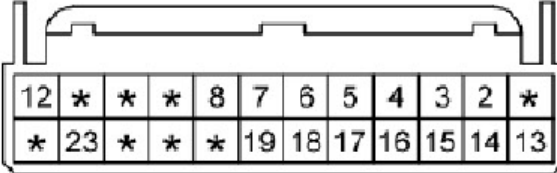
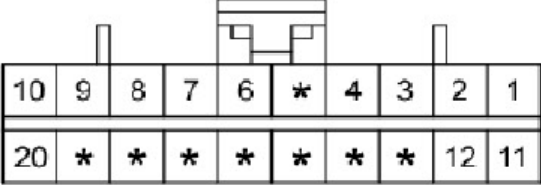
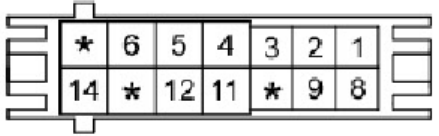
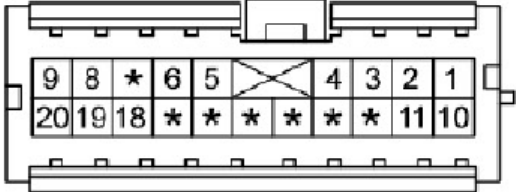
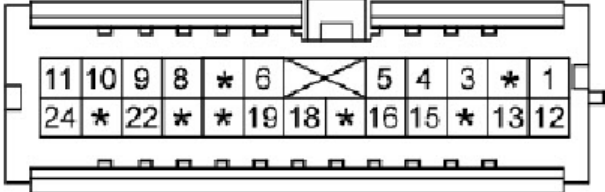

大灯连接器介绍

<p>CAG69</p>  <p>KUM_NMWP_06F_B</p>	<p>CBG69</p>  <p>KUM_NMWP_06F_B</p>	<p>E77</p>  <p>KUM_NMWP_06F_B</p>	<p>E91</p>  <p>CR05F051</p>
<p>E95</p>  <p>CR05F051</p>	<p>M01-A</p>  <p>AMP_025_24F_W</p>	<p>M01-B</p>  <p>AMP_040M1_20F_B</p>	<p>M02-L</p>  <p>AMP_0409_14F_W</p>
<p>M04-B</p>  <p>AMP_040III_20F_W</p>	<p>M04-C</p>  <p>AMP_040III_24F_GR</p>	<p>BLANK</p>	<p>BLANK</p>