

2.4 MFI 控制系统

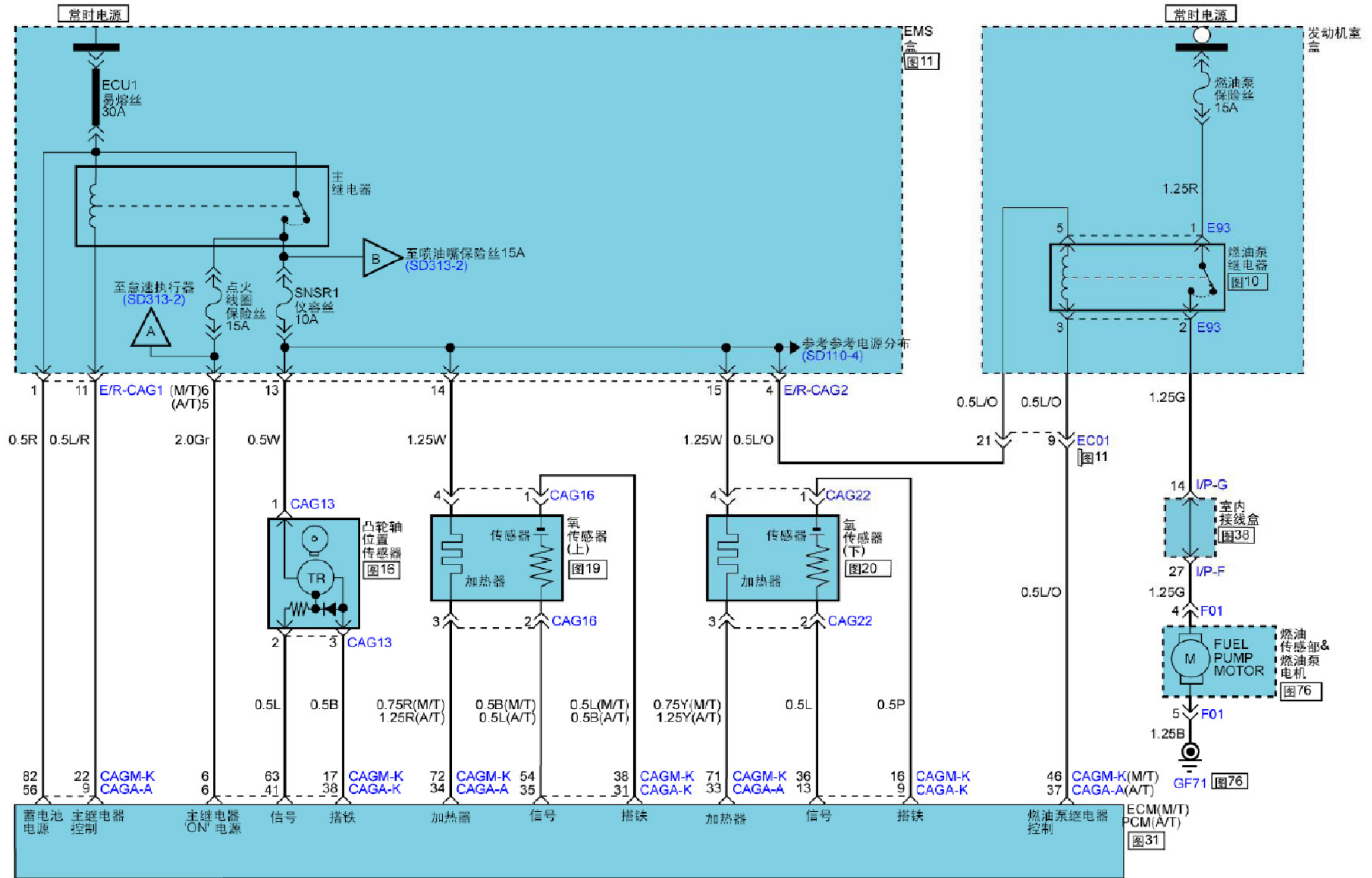

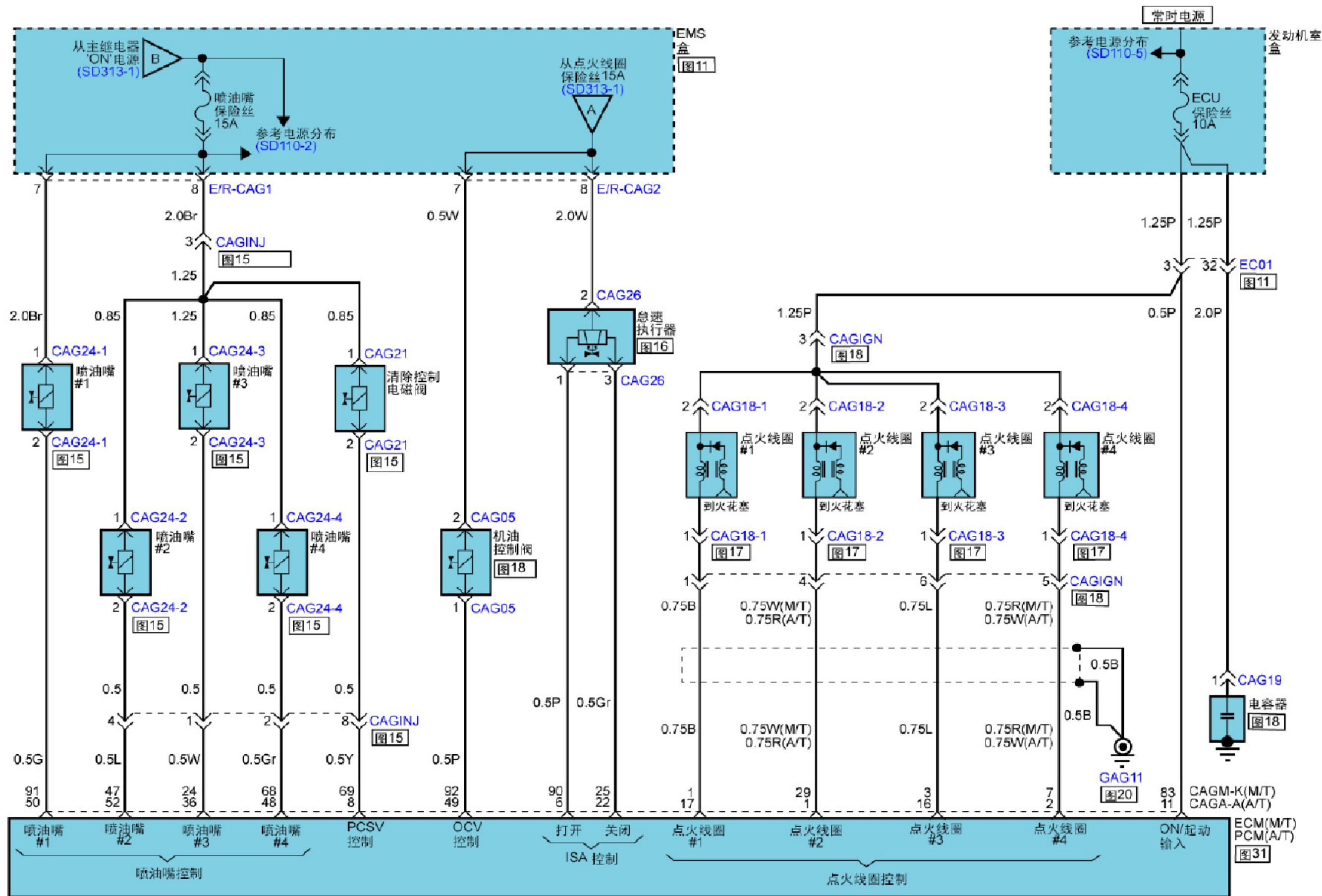

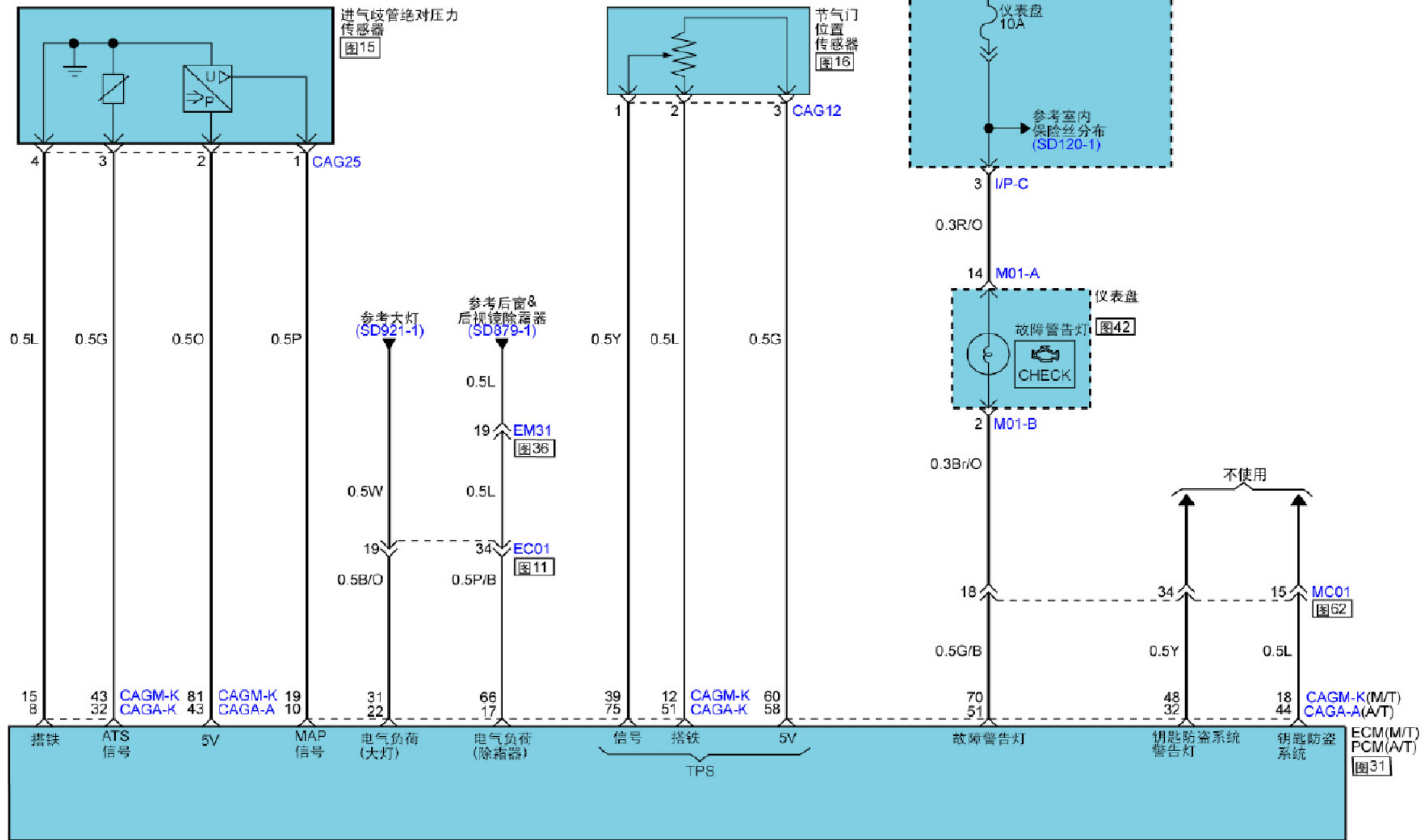

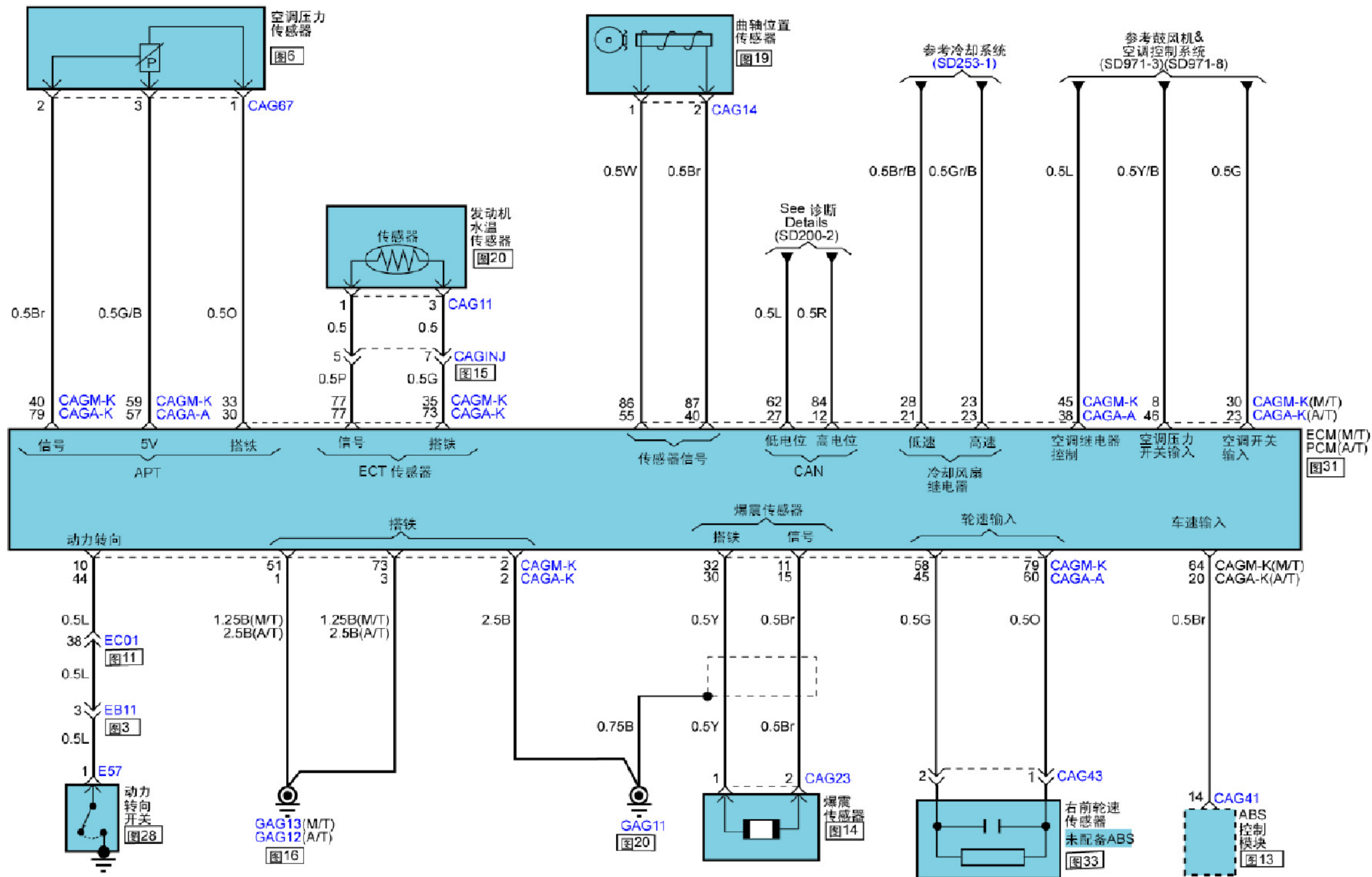



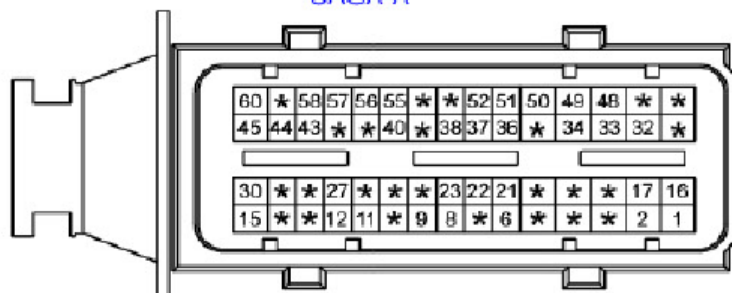
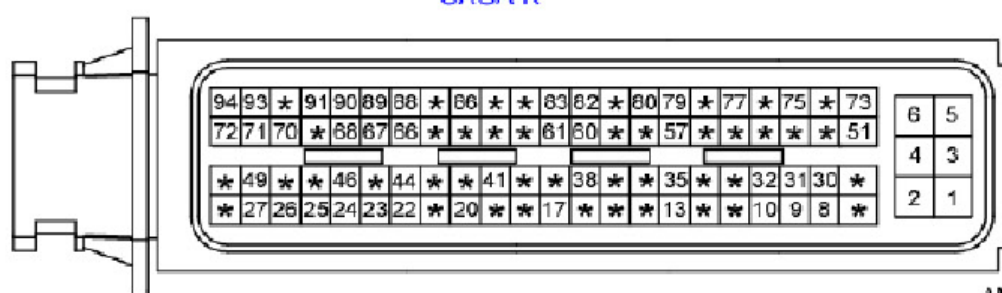
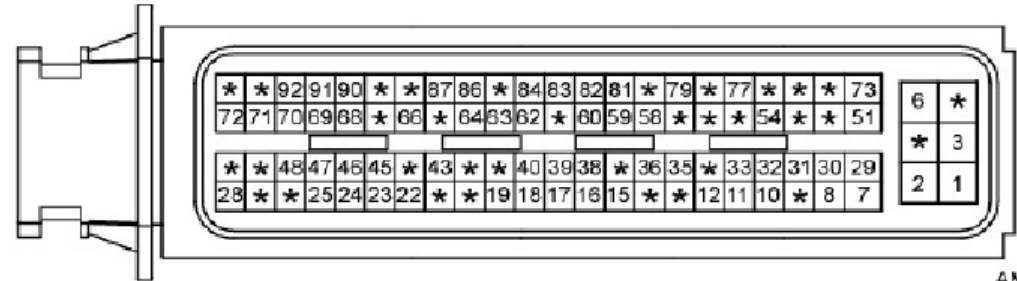

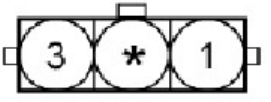
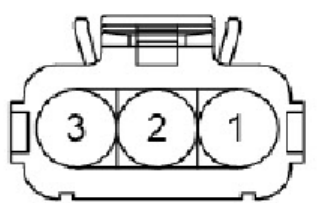
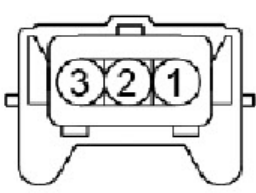

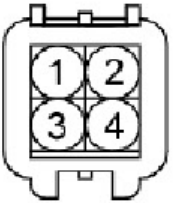

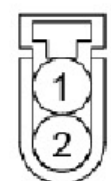
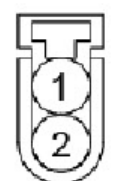
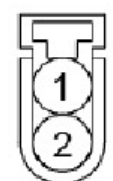
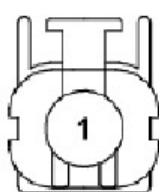
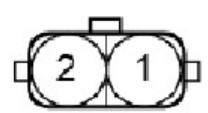
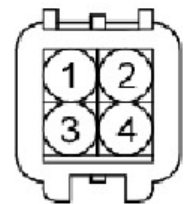



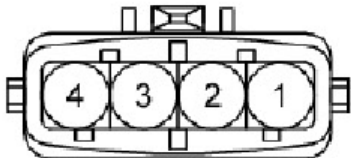
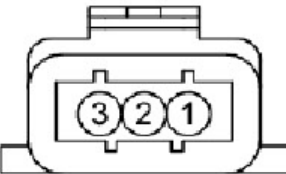
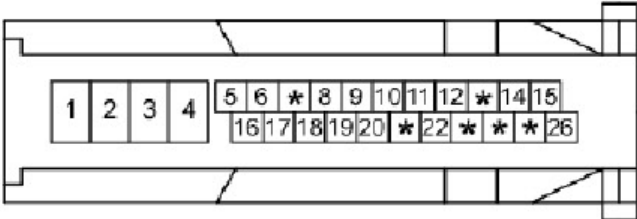
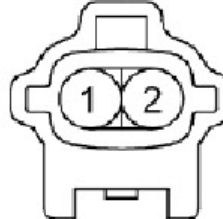
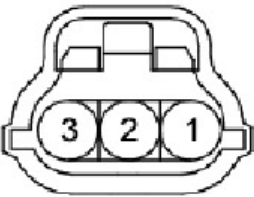
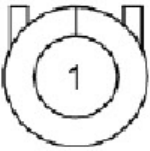
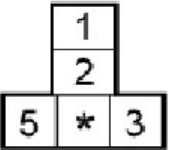

MFI 控制系统连接器介绍

<p style="text-align: center;">CAGA-A</p>  <p style="text-align: right;">AMP_ECU_60F_B</p>	<p style="text-align: center;">CAGA-K</p>  <p style="text-align: right;">AMP_ECU_94F_B</p>		
<p style="text-align: center;">CAGM-K</p>  <p style="text-align: right;">AMP_ECU_94F_B</p>	<p style="text-align: center;">CAG05</p>  <p style="text-align: right;">KET_090WP_02F_B_L</p>	<p style="text-align: center;">CAG11</p>  <p style="text-align: right;">CR03F139</p>	
<p style="text-align: center;">CAG12</p>  <p style="text-align: right;">AMP_JPT_03F_B_BOSCH</p>	<p style="text-align: center;">CAG13</p>  <p style="text-align: right;">AMP_JPT_03F_B_CLIP</p>	<p style="text-align: center;">CAG14</p>  <p style="text-align: right;">AMP_JPT_02F_B_CLIP</p>	<p style="text-align: center;">CAG16</p>  <p style="text-align: right;">KUM_NMWP_04M_B</p>
<p style="text-align: center;">CAG18-1</p>  <p style="text-align: right;">MLX_090WP_2F</p>	<p style="text-align: center;">CAG18-2</p>  <p style="text-align: right;">MLX_090WP_2F</p>	<p style="text-align: center;">CAG18-3</p>  <p style="text-align: right;">MLX_090WP_2F</p>	<p style="text-align: center;">CAG18-4</p>  <p style="text-align: right;">MLX_090WP_2F</p>
<p style="text-align: center;">CAG19</p>  <p style="text-align: right;">KET_58X_01F_B</p>	<p style="text-align: center;">CAG21</p>  <p style="text-align: right;">CR03F139</p>	<p style="text-align: center;">CAG22</p>  <p style="text-align: right;">KUM_NMWP_04M_B</p>	<p style="text-align: center;">CAG23</p>  <p style="text-align: right;">AMP_2.8WP_02F_B</p>

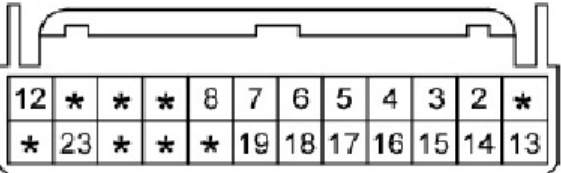
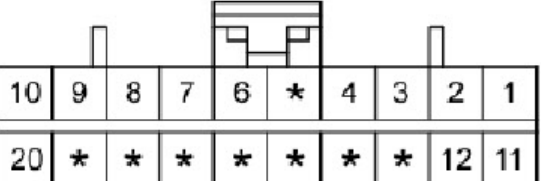
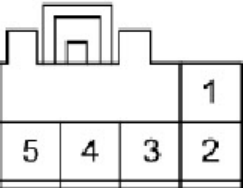
<p>CAG24-1</p>  <p>KUM_NDWP_02F_Gr</p>	<p>CAG24-2</p>  <p>KUM_NDWP_02F_Gr</p>	<p>CAG24-3</p>  <p>KUM_NDWP_02F_Gr</p>	<p>CAG24-4</p>  <p>KUM_NDWP_02F_Gr</p>
<p>CAG25</p>  <p>AMP_JPT_04F_B_BOSCH</p>	<p>CAG26</p>  <p>AMP_ISA_03F_B</p>	<p>CAG41</p>  <p>BOS_ABS_26F_B_L</p>	<p>CAG43</p>  <p>KET_090IIVP_02M_Gr</p>
<p>CAG67</p>  <p>KET_040WP_03F_B</p>	<p>E57</p>  <p>KET_156_01F_W_TML</p>	<p>E93</p>  <p>CR05F051</p>	<p>F01</p>  <p>KET_090IIVP_05F_Gr_2</p>
<p>M01-A</p>  <p>AMP_025_24F_W</p>	<p>M01-B</p>  <p>AMP_040M1_20F_B</p>	<p>M09</p>  <p>KUM_CDR_05F_W</p>	<p>BLANK</p>

2.5 自动变速器控制系统

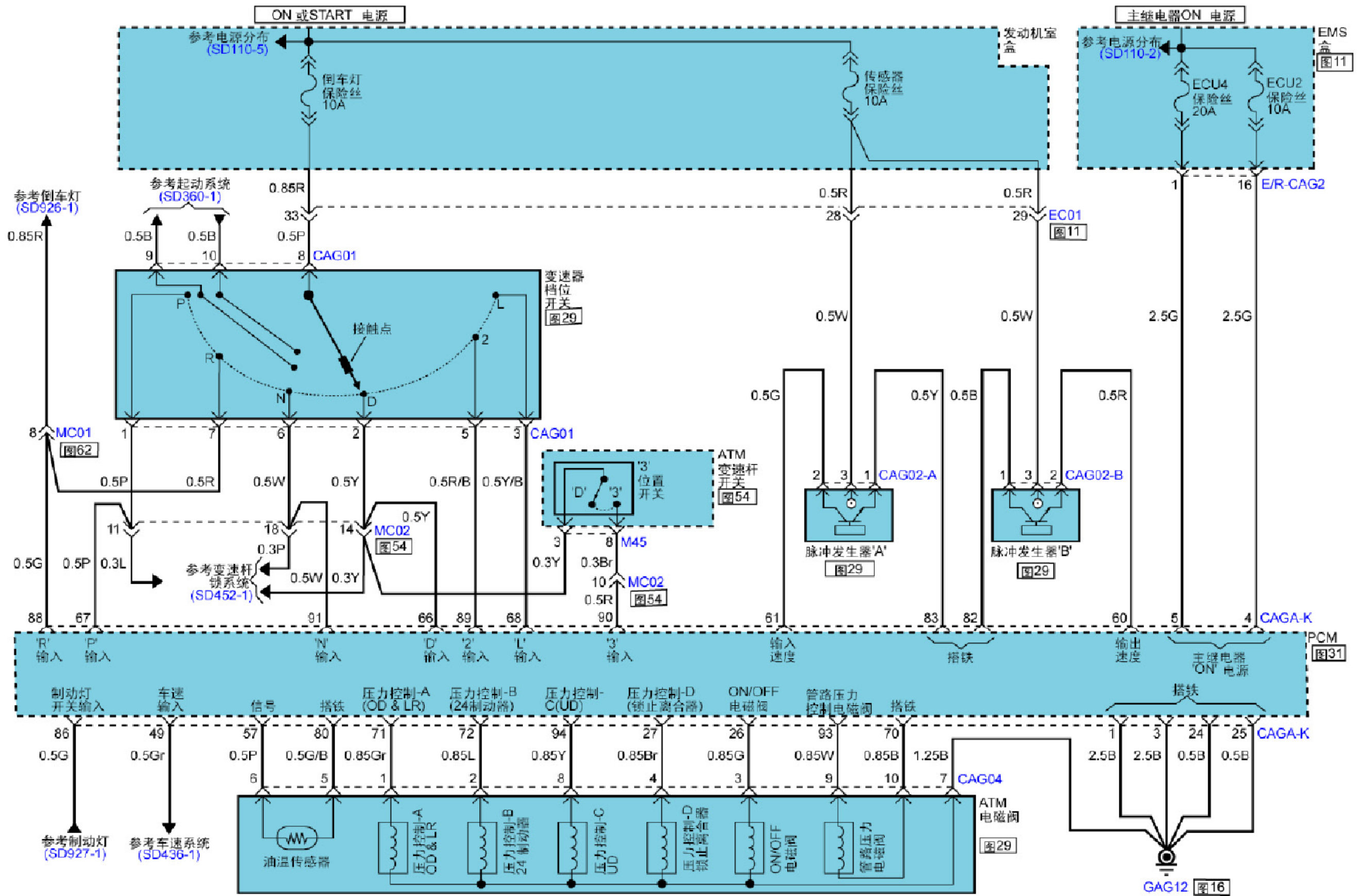

自动变速器控制系统连接器介绍

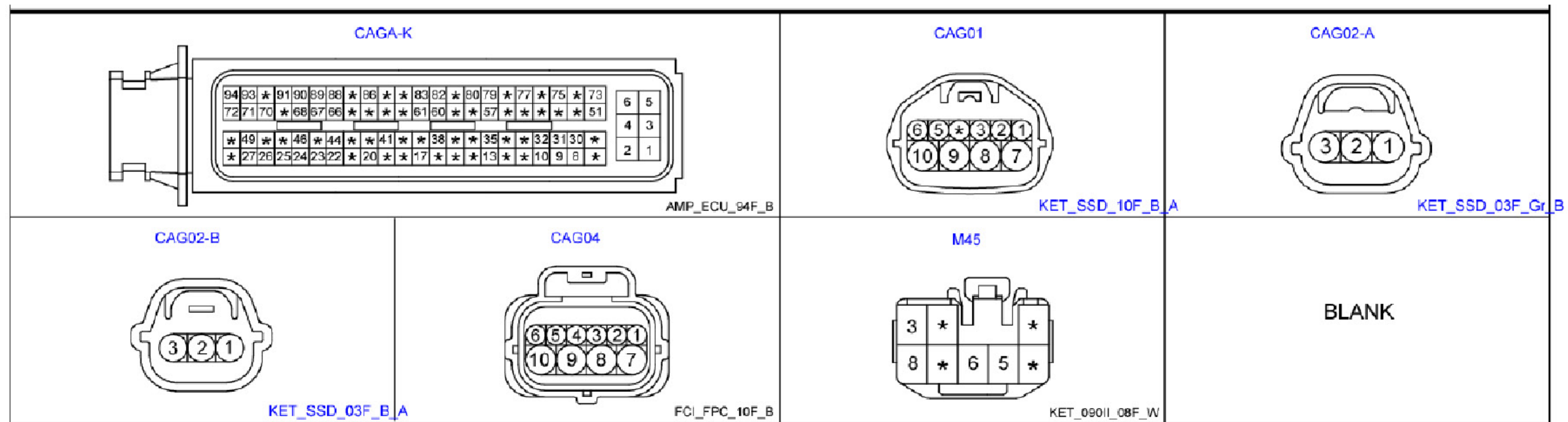

LAUNCH