

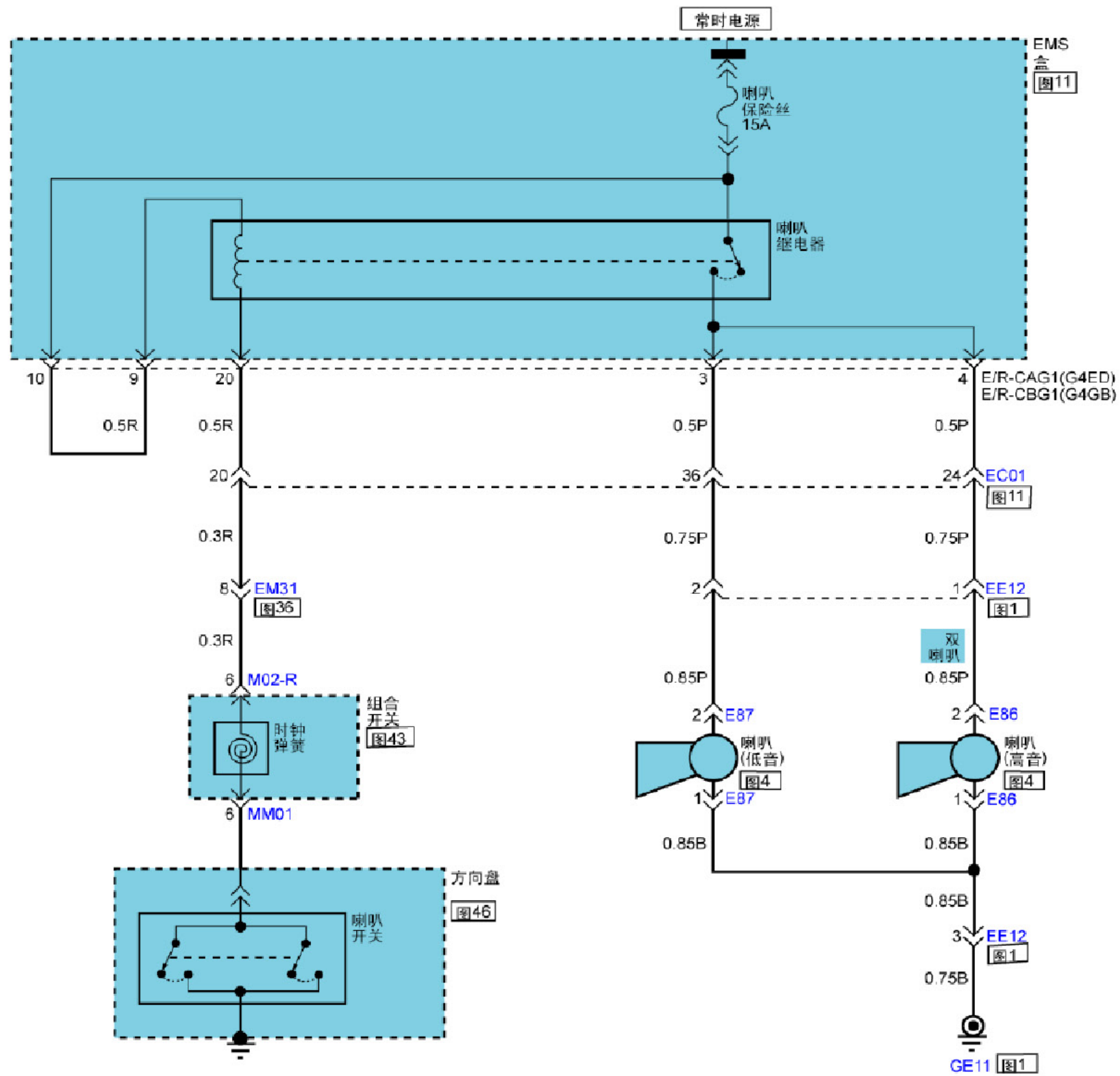

2.15 喇叭



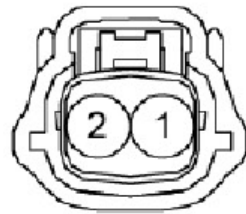
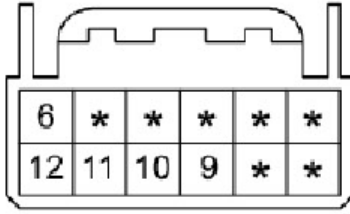

<p>E86</p>  <p>A diagram of a two-pin connector with two circular terminals labeled '2' and '1'.</p>	<p>E87</p>  <p>A diagram of a two-pin connector with two circular terminals labeled '2' and '1'.</p>	<p>M02-R</p>  <p>A diagram of a six-pin connector with a grid of terminals. The top row contains terminals 6, *, *, *, *, *. The bottom row contains terminals 12, 11, 10, 9, *, *.</p> <table border="1" data-bbox="1632 430 1958 556"><tr><td>6</td><td>*</td><td>*</td><td>*</td><td>*</td><td>*</td></tr><tr><td>12</td><td>11</td><td>10</td><td>9</td><td>*</td><td>*</td></tr></table>	6	*	*	*	*	*	12	11	10	9	*	*	<p>BLANK</p>
6	*	*	*	*	*										
12	11	10	9	*	*										

LAUNCH

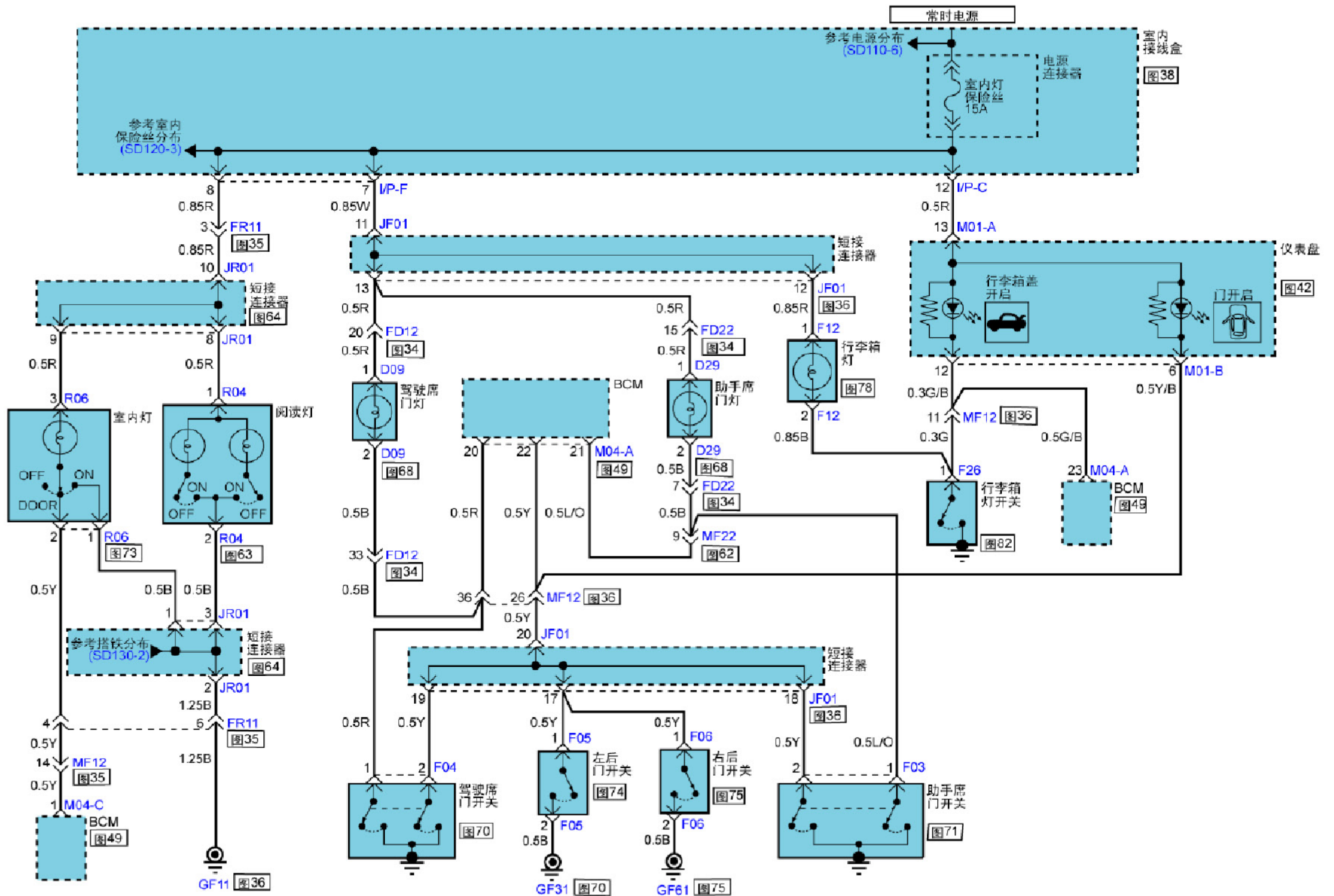
2.16 行李箱灯



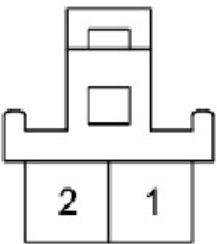
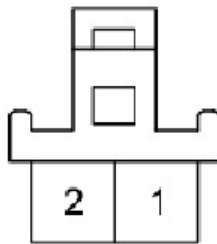
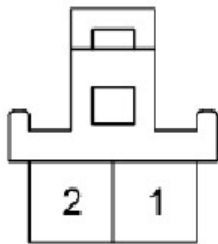
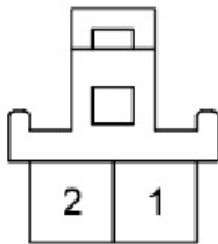
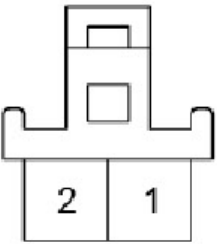
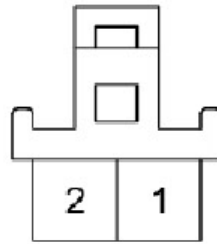
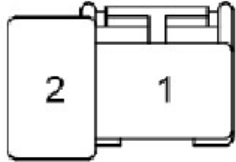

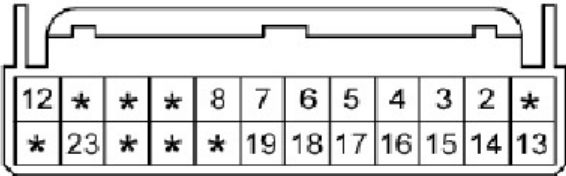
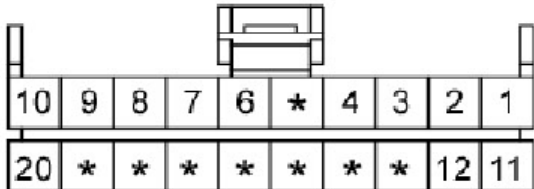
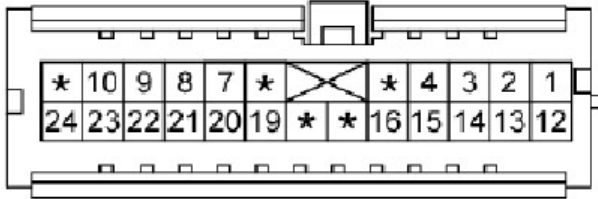
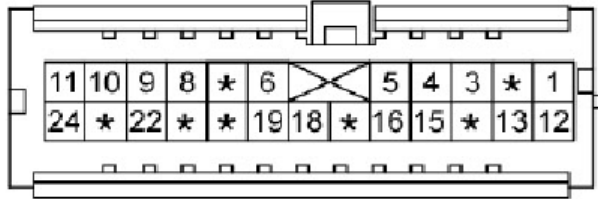
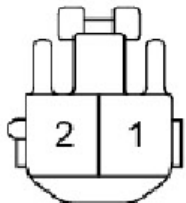
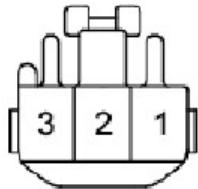
行李箱灯连接器介绍

<p>D09</p>  <p>KET_070_02F_W</p>	<p>D29</p>  <p>KET_070_02F_W</p>	<p>F03</p>  <p>KET_070_02F_W</p>	<p>F04</p>  <p>KET_070_02F_W</p>
<p>F05</p>  <p>KET_070_02F_W</p>	<p>F06</p>  <p>KET_070_02F_W</p>	<p>F12</p>  <p>AMP_PLM2_02F_B_DL</p>	<p>F26</p>  <p>KET_090II_01M_W_CLIP</p>
<p>M01-A</p>  <p>AMP_025_24F_W</p>	<p>M01-B</p>  <p>AMP_040M1_20F_B</p>	<p>M04-A</p>  <p>AMP_040III_24F_W</p>	<p>M04-C</p>  <p>AMP_040III_24F_GR</p>
<p>R04</p>  <p>KET_090II_02F_W_L</p>	<p>R06</p>  <p>KET_090II_03F_W</p>	<p>BLANK</p>	<p>BLANK</p>

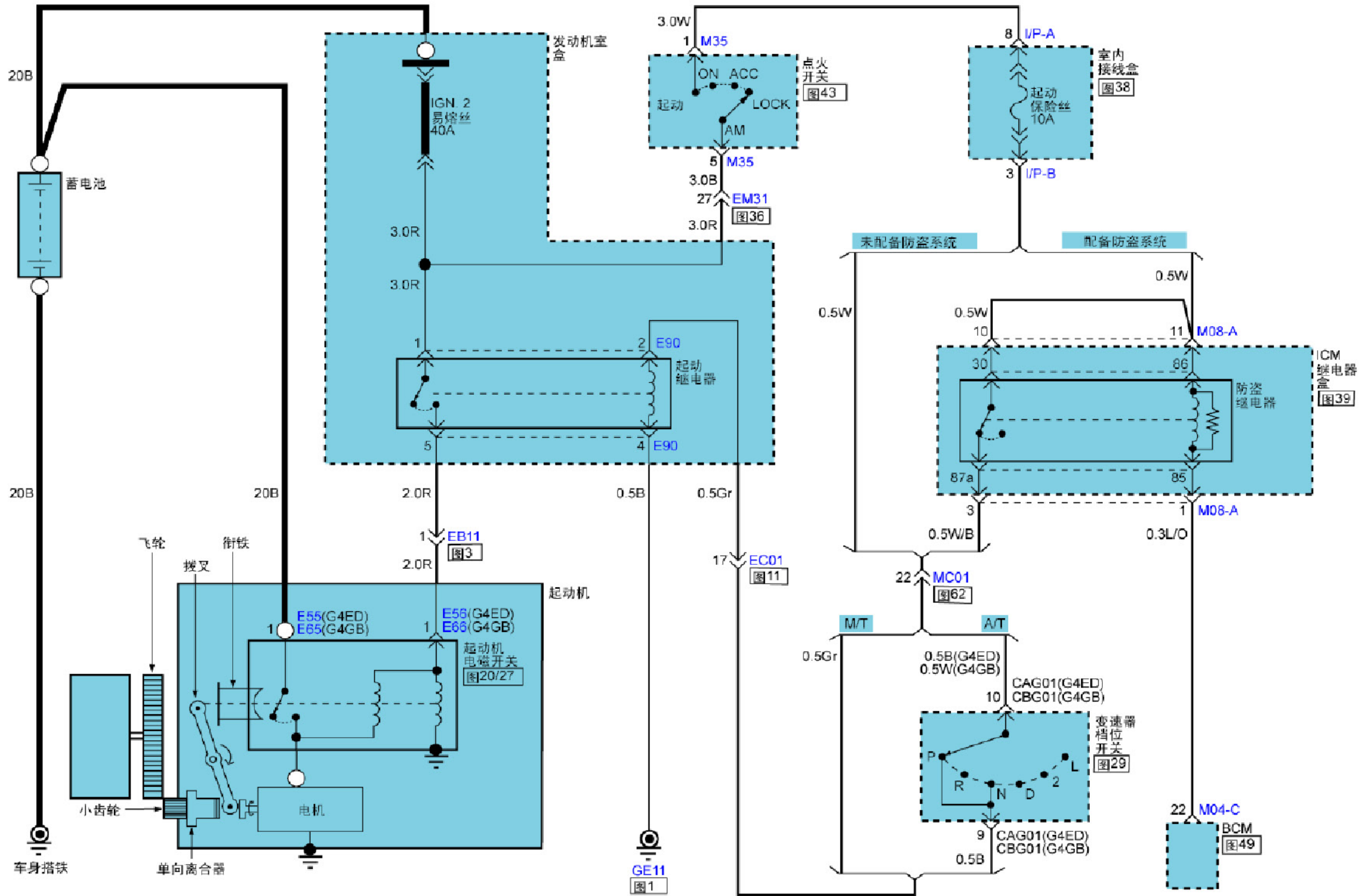
2.17 起动系统



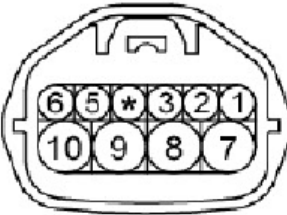
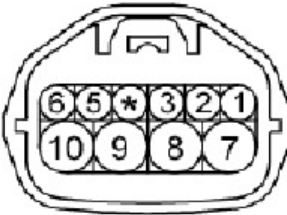
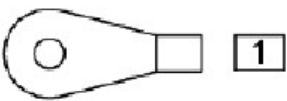
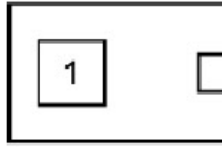
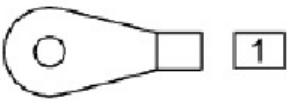

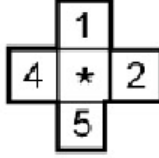
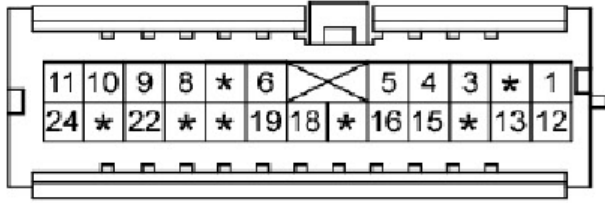
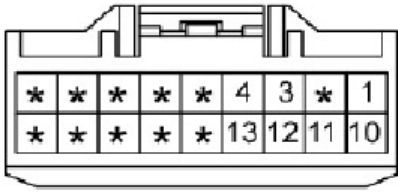
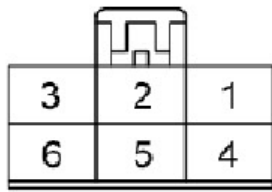
起动系统连接器介绍

<p>CAG01</p>  <p>KET_SSD_10F_B_A</p>	<p>CBG01</p>  <p>KET_SSD_10F_B_A</p>	<p>E55</p>  <p>CHT_STMTR_8T_N</p>	<p>E56</p>  <p>CR01F016</p>
<p>E65</p>  <p>CHT_STMTR_8T_N</p>	<p>E66</p>  <p>AMP_PLM2_01F_B</p>	<p>E90</p>  <p>CR05F034</p>	<p>M04-C</p>  <p>AMP_040III_24F_GR</p>
<p>M08-A</p>  <p>AMP_080III_18F_W</p>	<p>M35</p>  <p>KUM_DSD_06F_W</p>	<p>BLANK</p>	<p>BLANK</p>

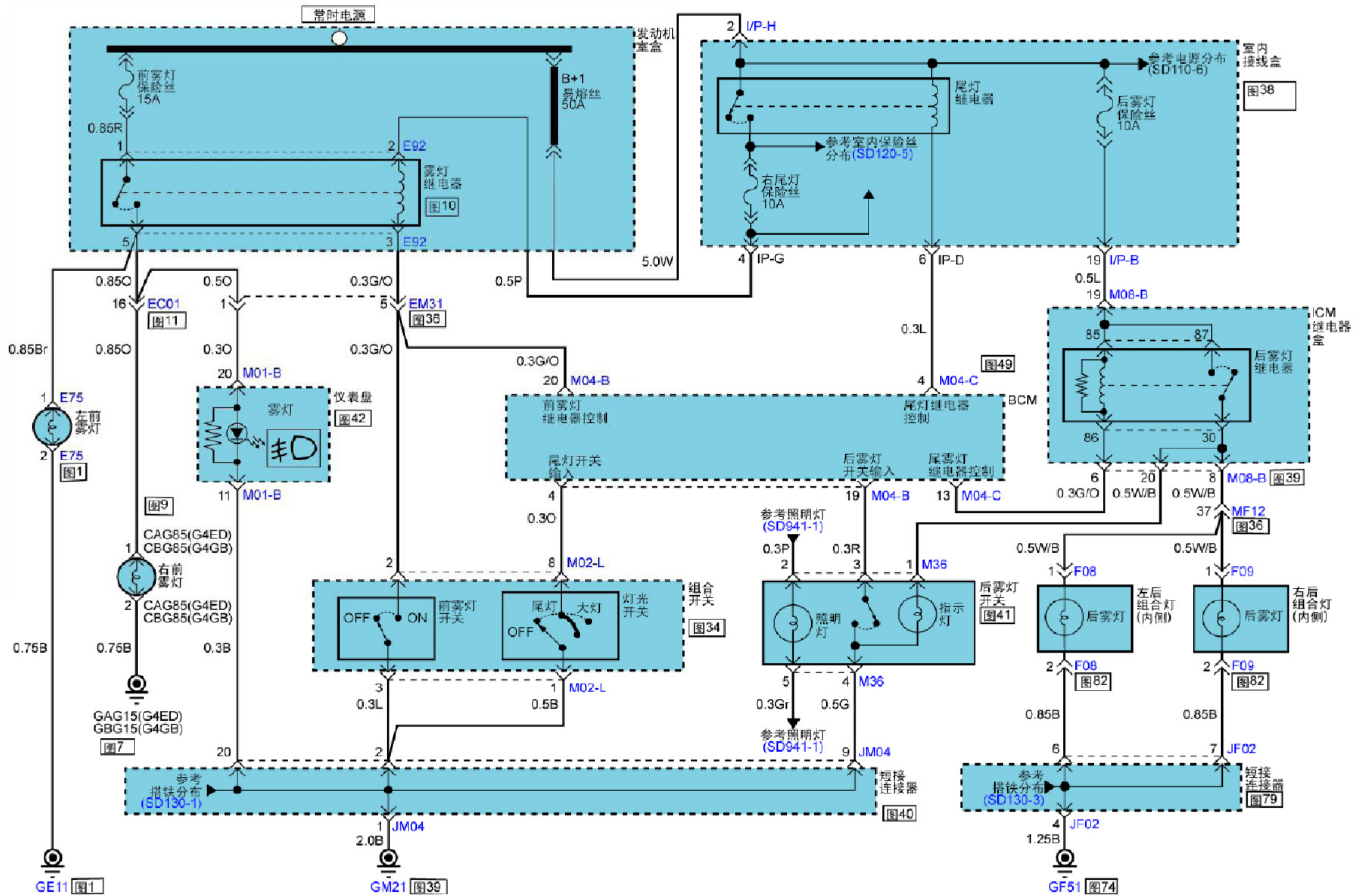



2.18 雾灯

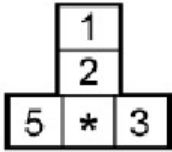
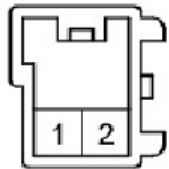
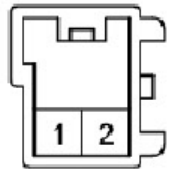
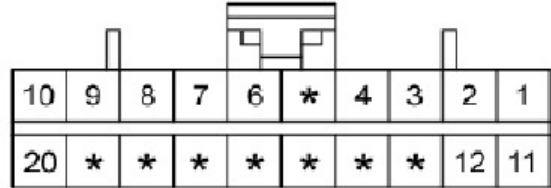
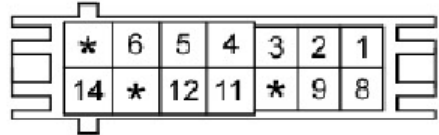
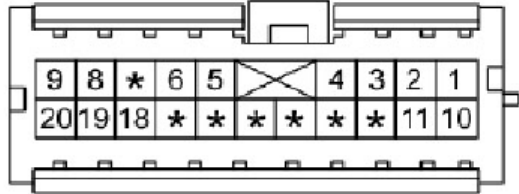
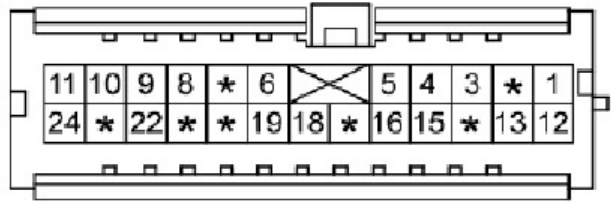
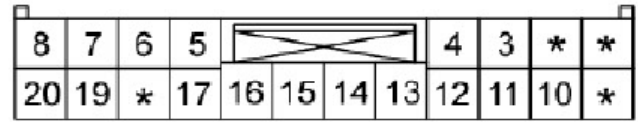
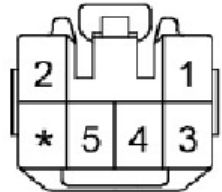

雾灯连接器介绍

<p style="text-align: center;">CAG85</p>  <p style="text-align: center;">KET_110WP_02F_B_FOG</p>	<p style="text-align: center;">CBG85</p>  <p style="text-align: center;">KET_110WP_02F_B_FOG</p>	<p style="text-align: center;">E75</p>  <p style="text-align: center;">KET_110WP_02F_B_FOG</p>	<p style="text-align: center;">E92</p>  <p style="text-align: right;">CR05F051</p>
<p style="text-align: center;">F08</p>  <p style="text-align: center;">KUM_CDR_02M_W</p>	<p style="text-align: center;">F09</p>  <p style="text-align: center;">KUM_CDR_02M_W</p>	<p style="text-align: center;">M01-B</p>  <p style="text-align: center;">AMP_040M1_20F_B</p>	<p style="text-align: center;">M02-L</p>  <p style="text-align: right;">AMP_0409_14F_W</p>
<p style="text-align: center;">M04-B</p>  <p style="text-align: center;">AMP_040III_20F_W</p>	<p style="text-align: center;">M04-C</p>  <p style="text-align: center;">AMP_040III_24F_GR</p>	<p style="text-align: center;">M08-B</p>  <p style="text-align: center;">AMP_0925_20F_W</p>	<p style="text-align: center;">M36</p>  <p style="text-align: right;">KET_090II_06F_R</p>

前雨刮器连接器介绍

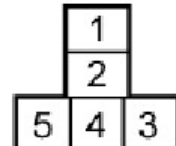
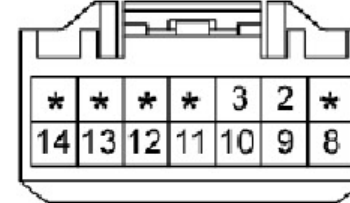
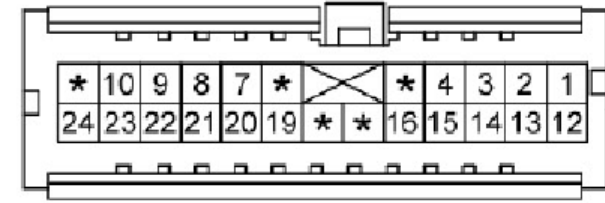
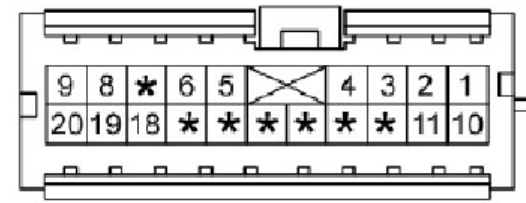
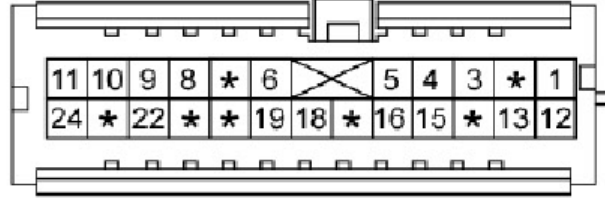
<p>CAG07</p>  <p>KUM_NMWP_06F_B</p>	<p>CAG54</p>  <p>KET_090IWP_03F_B</p>	<p>CBG07</p>  <p>KUM_NMWP_06F_B</p>	<p>CBG54</p>  <p>KET_090IWP_03F_B</p>
<p>E94</p>  <p>CR05F051</p>	<p>M02-W</p>  <p>AMP_090III_14F_W</p>	<p>M04-A</p>  <p>AMP_040III_24F_W</p>	<p>M04-B</p>  <p>AMP_040III_20F_W</p>
<p>M04-C</p>  <p>AMP_040III_24F_GR</p>	<p>BLANK</p>	<p>BLANK</p>	<p>BLANK</p>