

- J179
- J299
- J519
- J623
- SB20
- SB25
- SB26
- SB27
- T40
- T121
- V101
- \*
- 

- blv = 蓝紫色
- ws = 白色
- =
- ro = 红色
- =
- gn = 绿色
- =
- gr = 灰色
- =
- ge = 黄色
- =
- rs = 粉红色

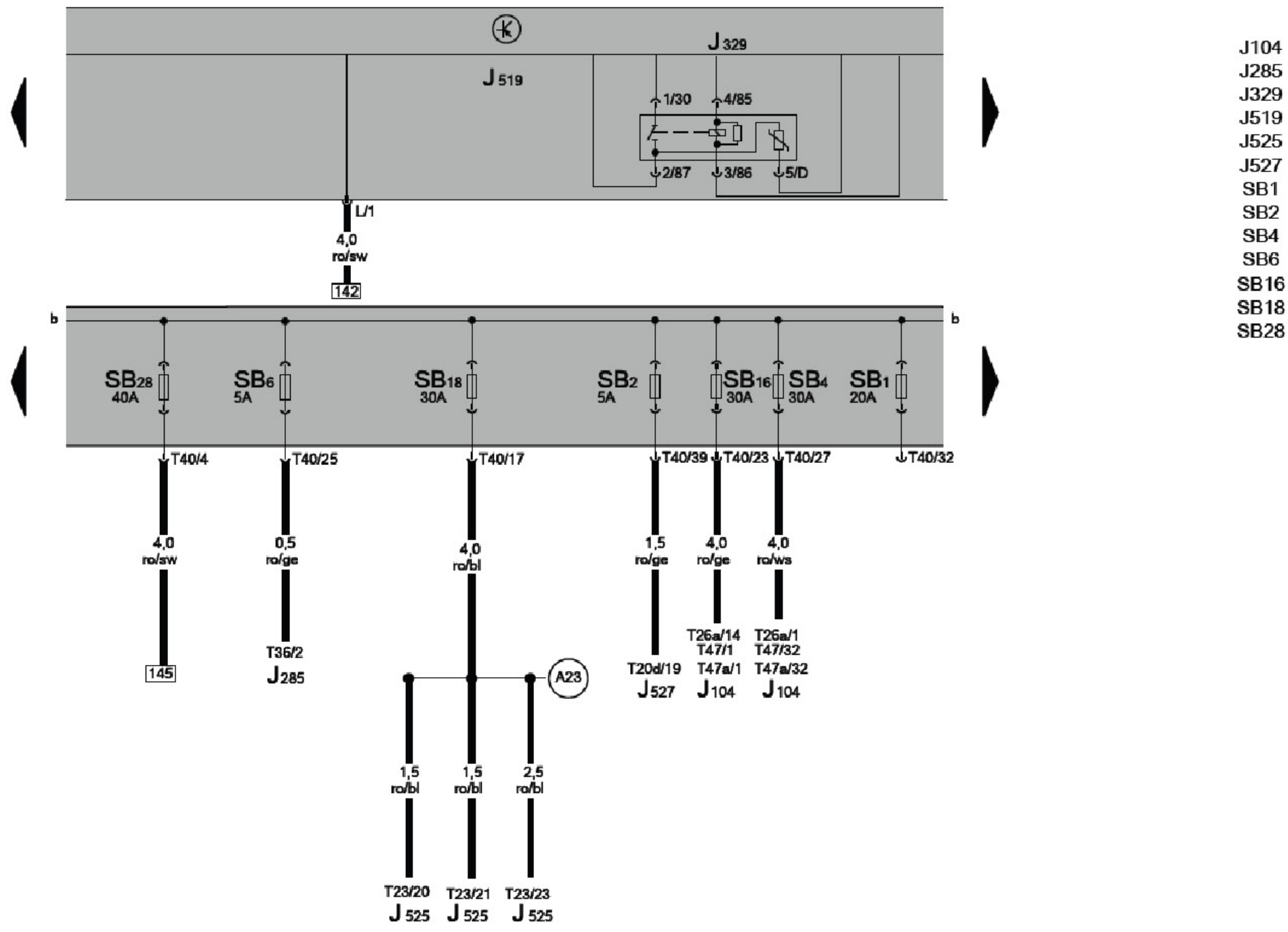

- J104
- J285
- J329
- J519
- J525
- J527
- SB1
- SB2
- SB4
- SB6
- SB16
- SB18
- SB28

- blv 藕紫色
- ws = 白色
- =
- ro 红色
- =
- gn 绿色
- =
- gr 灰色
- =
- ge 黄色
- =
- rs 粉红色

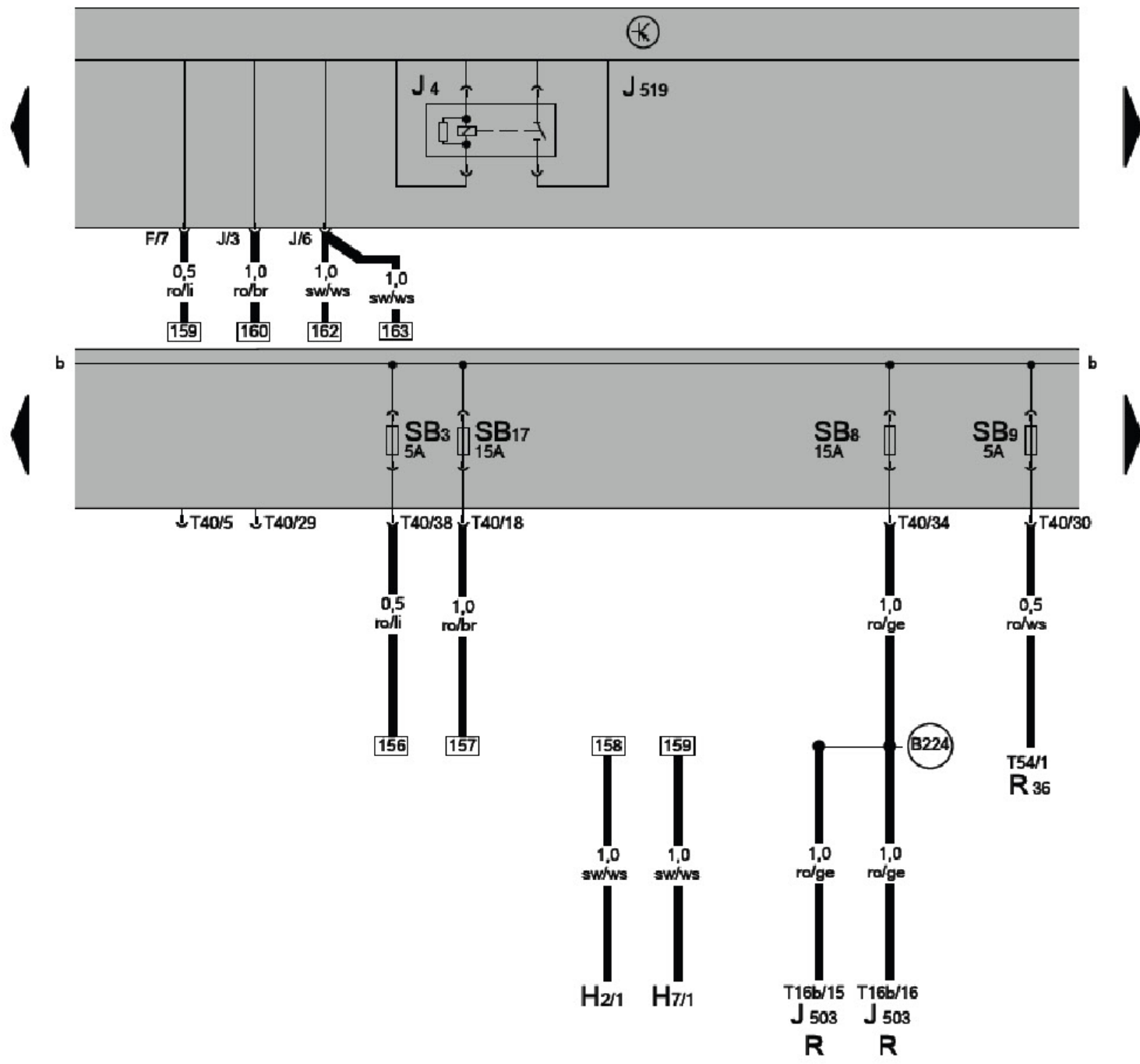

- H2
- H7
- J4
- J503
- J519
- R
- R36
- SB3
- SB8
- SB9
- SB17
- T16b
- T40

155 156 157 158 159 160 161 162 163 164 165 166 167 168

1K2-171130806

- blv 蓝色
- ws = 白色
- =
- ro 红色
- =
- gn 绿色
- =
- gr 灰色
- =
- ge 黄色
- =
- rs 粉红色

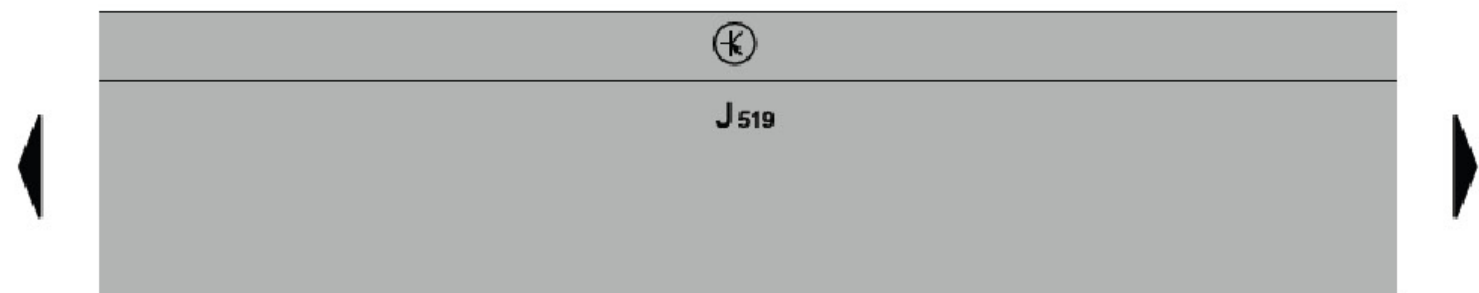

- J364
- J400
- J519
- J533
- SB10
- SB11
- SB12
- SB19
- T2g
- T4p
- T20
- T40

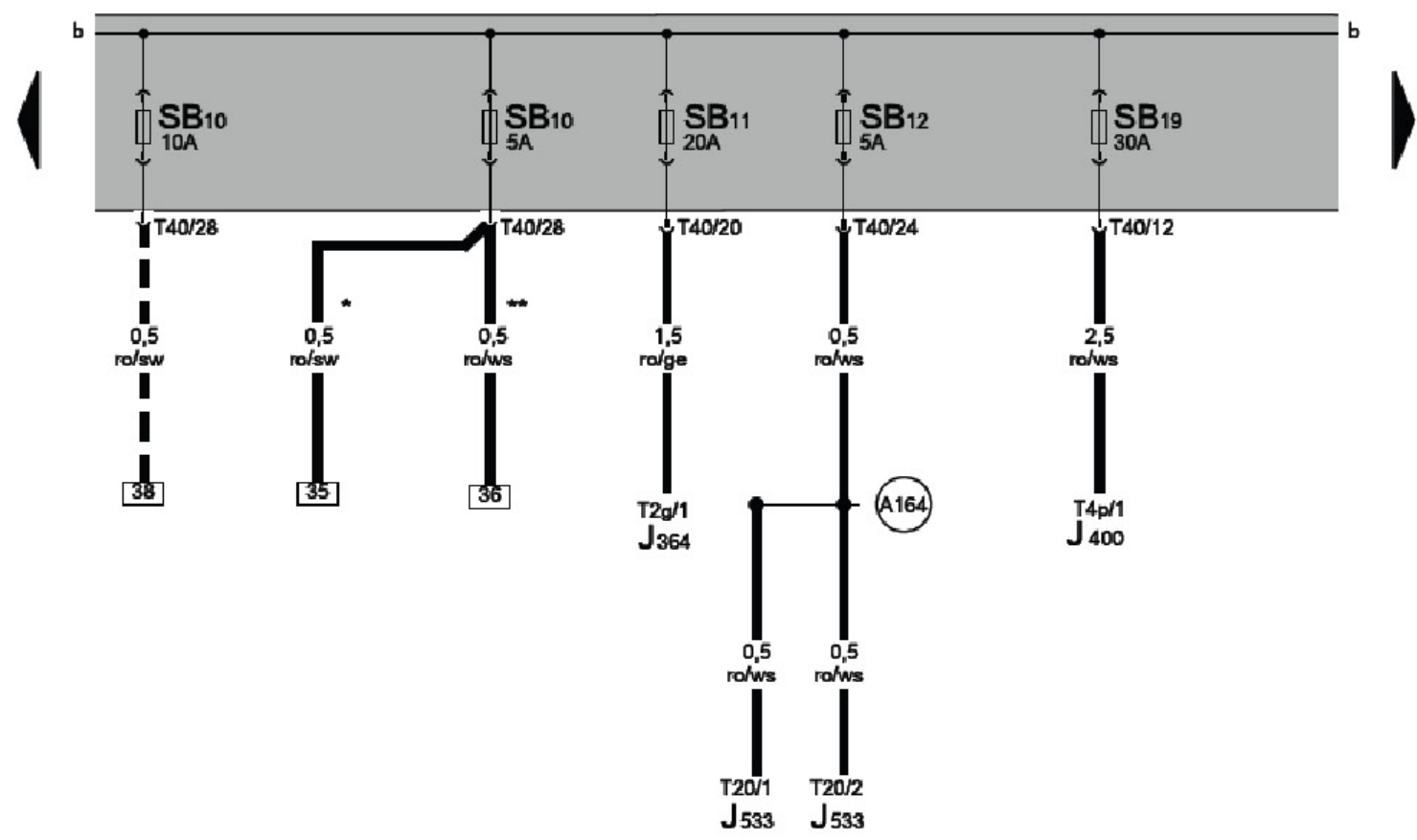

169 170 171 172 173 174 175 176 177 178 179 180 181 182

1K2-171140806

- blw 蓝色
- ws = 白色
- =
- ro 红色
- =
- gn 绿色
- =
- gr 灰色
- =
- ge 黄色
- =
- rs 粉红色

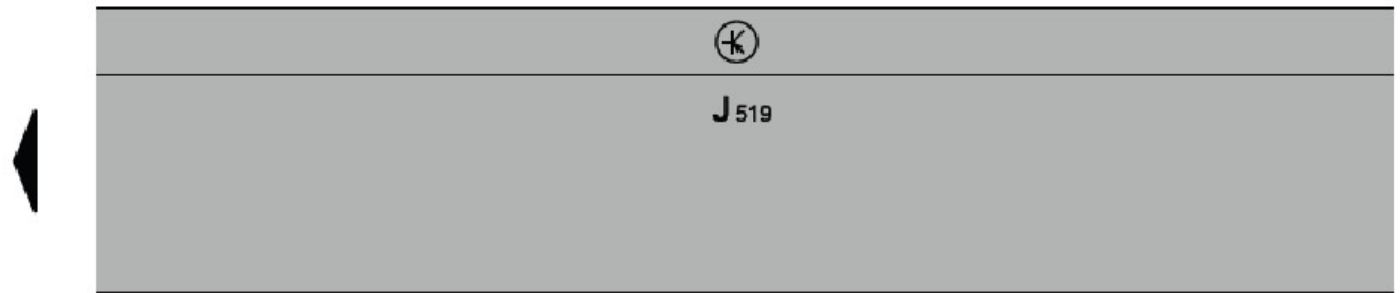

- E425
- J519
- J743
- S44
- SB5
- SB7
- SB29
- SB30
- T8c
- T10a
- T20e
- T40

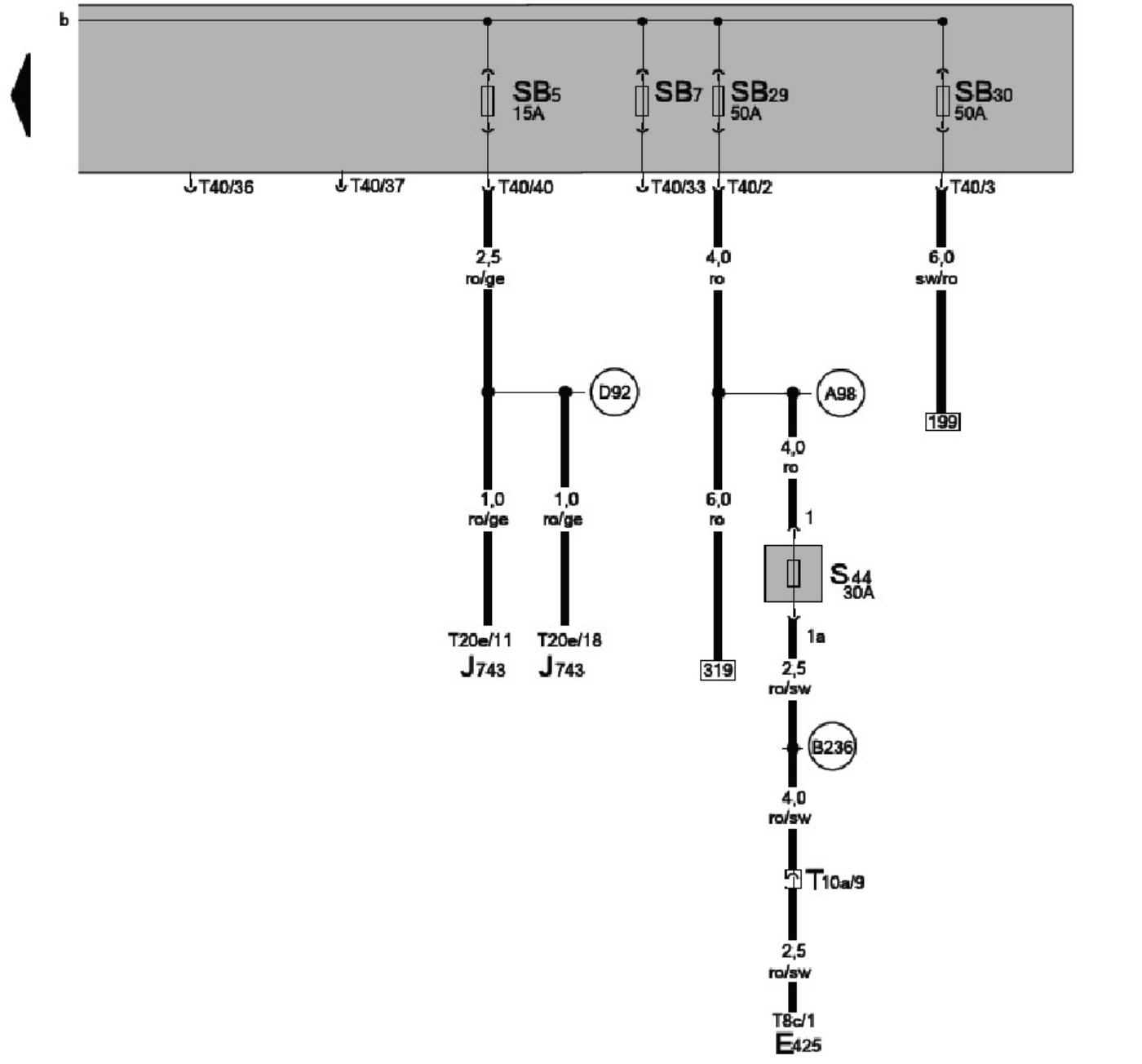

183 184 185 186 187 188 189 190 191 192 193 194 195 196  
 1K2-171150806

- blv = 蓝色
- ws = 白色
- ro = 红色
- gn = 绿色
- gr = 灰色
- ge = 黄色
- rs = 粉红色

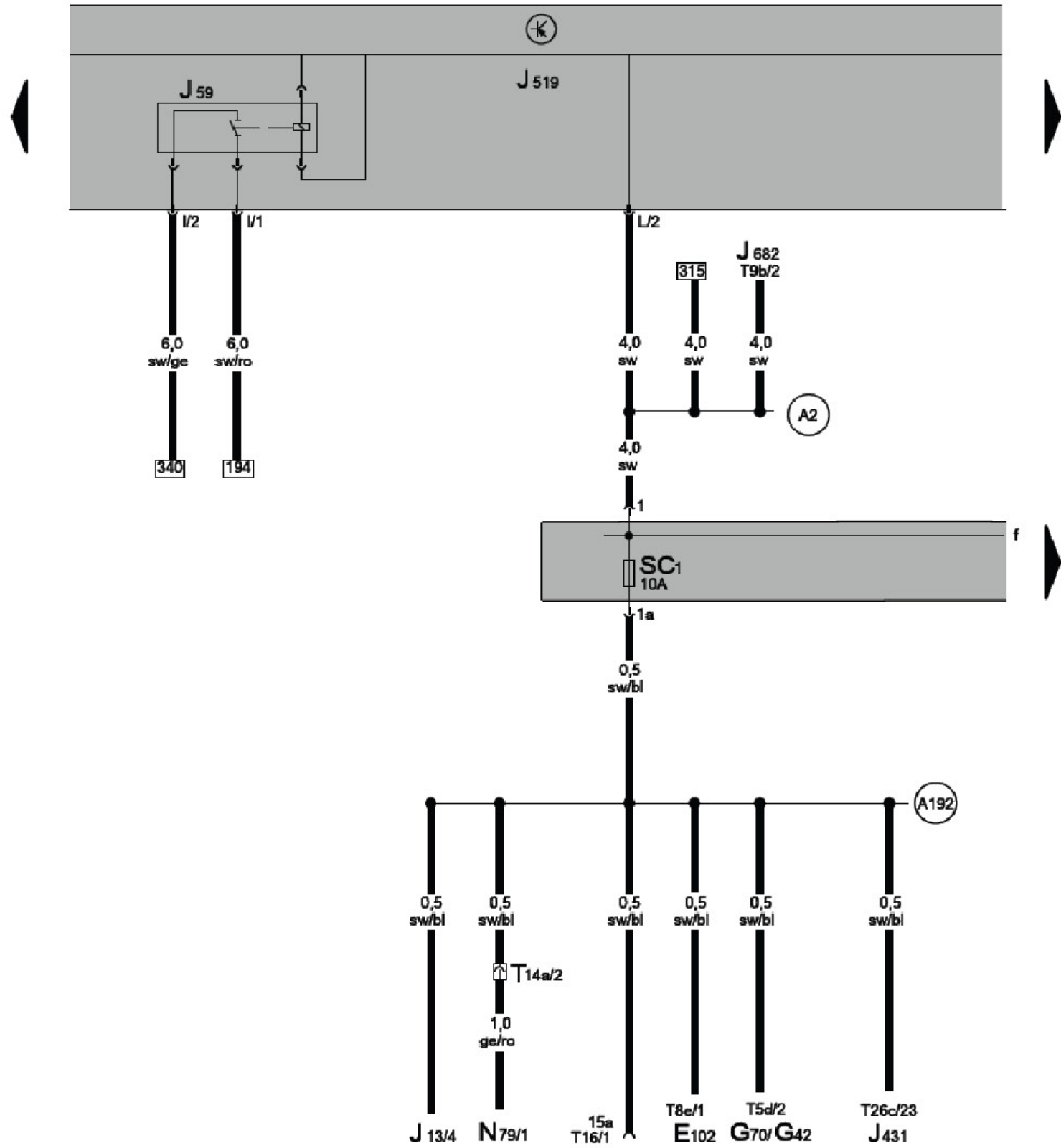

- E102
- G42
- G70
- J13
- J59
- J431
- J519
- J682
- N79
- SC1
- T5d
- T8e
- T9b

- bl/v = 藕紫色
- ws = 白色
- ro = 红色
- gn = 绿色
- gr = 灰色
- ge = 黄色
- rs = 粉红色

197 198 199 200 201 202 203 204 205 206 207 208 209 210

1K2-171160806

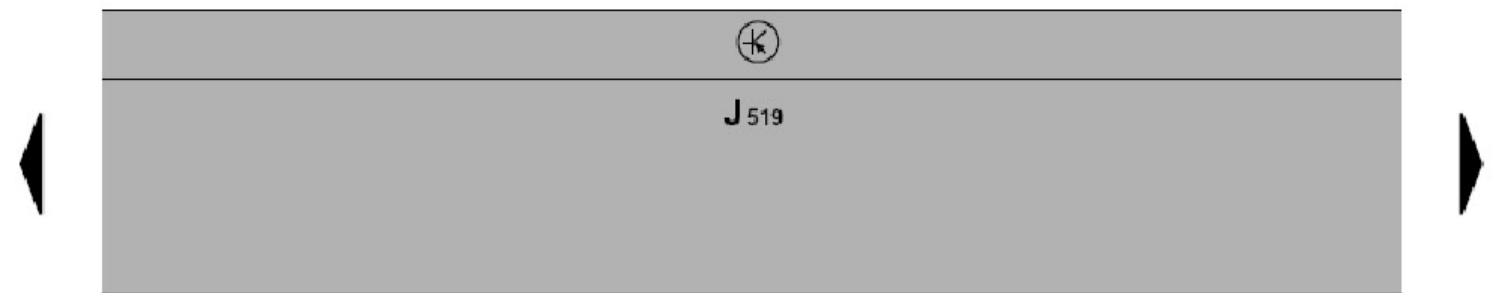

- E256
- E492
- F4
- G65
- G266
- J255
- J301
- J519
- SC4
- T2t
- T2u
- T3c
- T6z
- T6ad
- T6aj

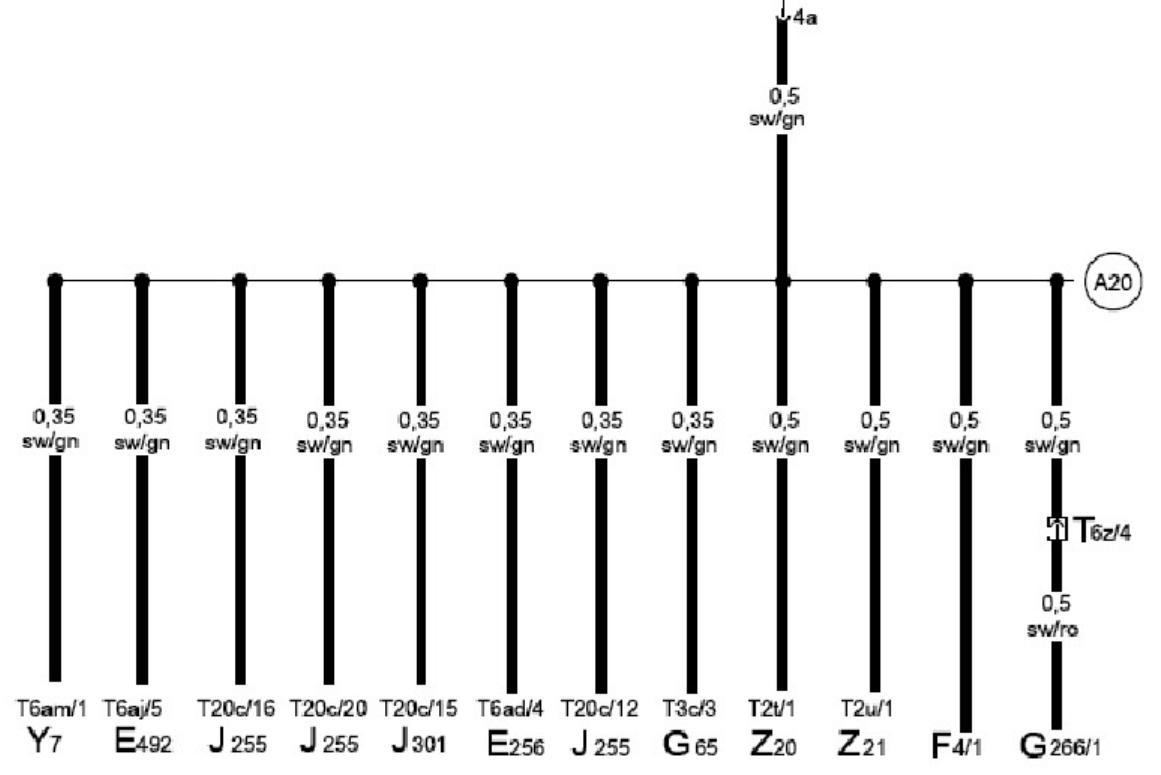
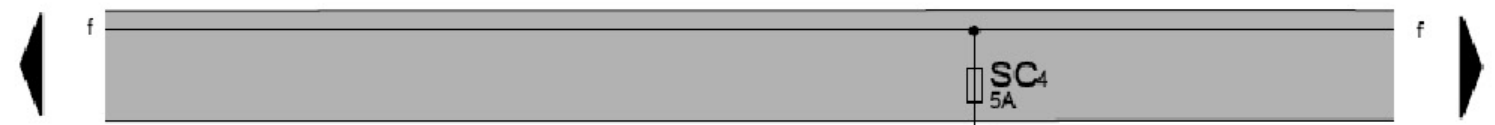

211   212   213   214   215   216   217   218   219   220   221   222   223   224

1K2-171170806

- blv = 橘黄色
- ws = 白色
- ro = 红色
- gn = 绿色
- gr = 灰色
- ge = 黄色
- rs = 粉红色



- E1
- F
- F189
- J17
- J104
- J285
- J500
- J519
- J530
- J533
- J587
- J623
- J743
- SC2
- T4y

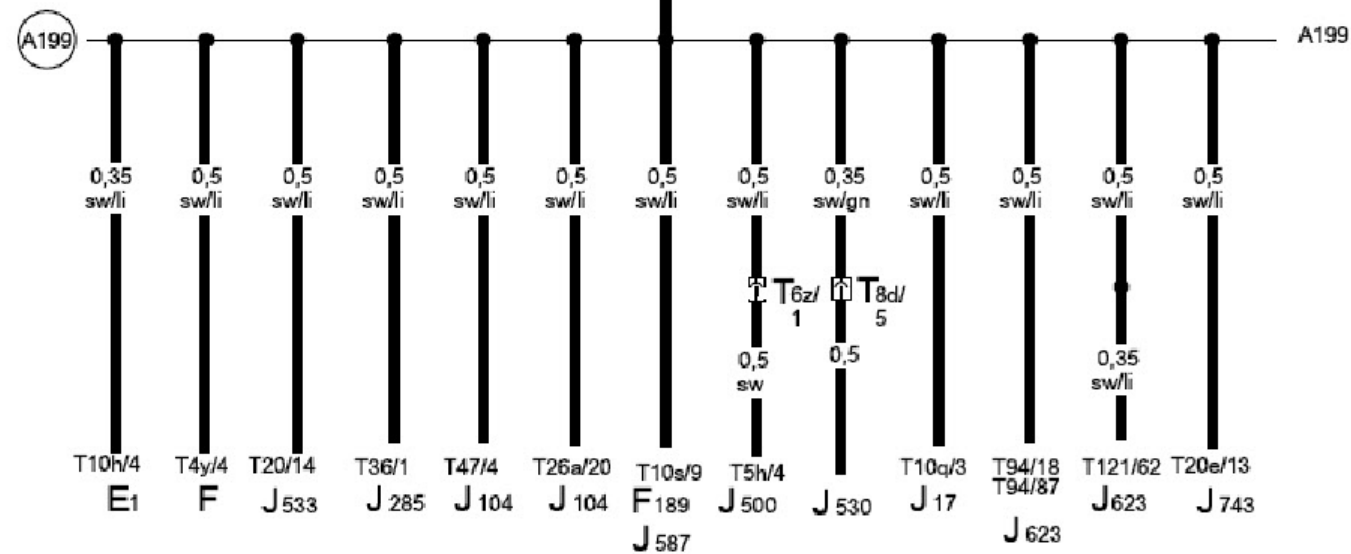
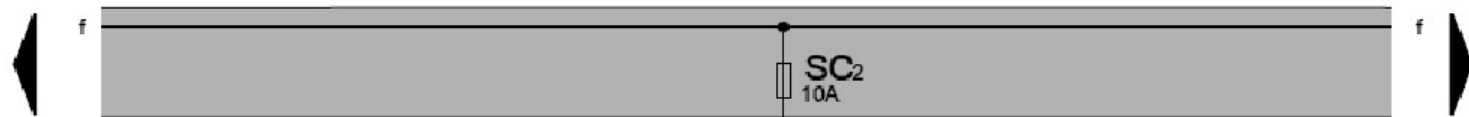

- blv = 蓝色
- ws = 白色
- ro = 红色
- gn = 绿色
- gr = 灰色
- ge = 黄色
- rs = 粉红色

225    226    227    228    229    230    231    232    233    234    235    236    237    238

1K2-171180806



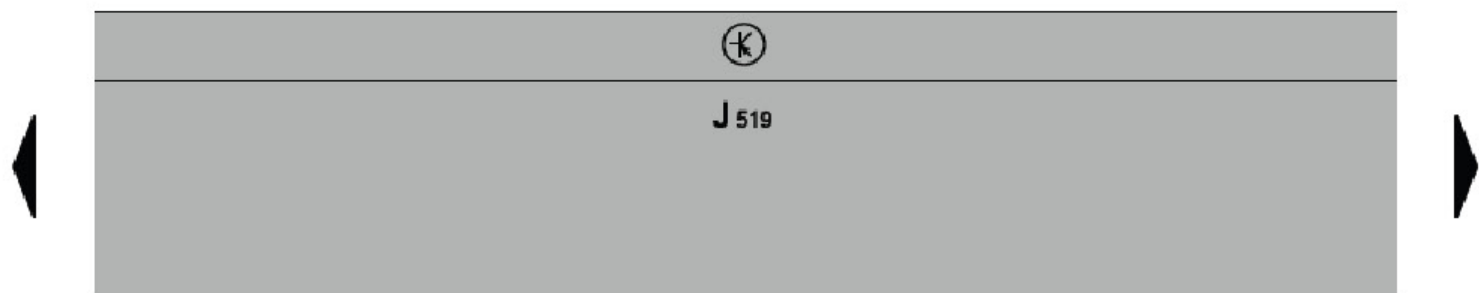

- J104
- J234
- J519
- J538
- K145
- SC3
- SC5
- SC6
- T4g
- T10i
- T10j
- T10v
- T47
- T47a
- T50

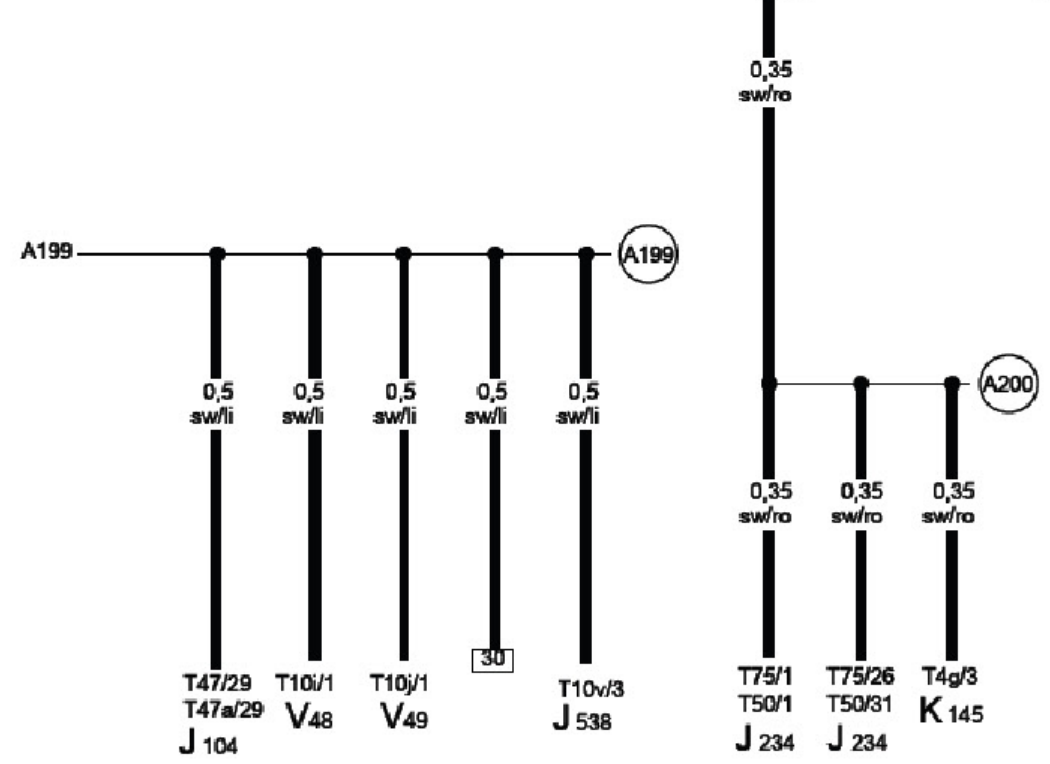
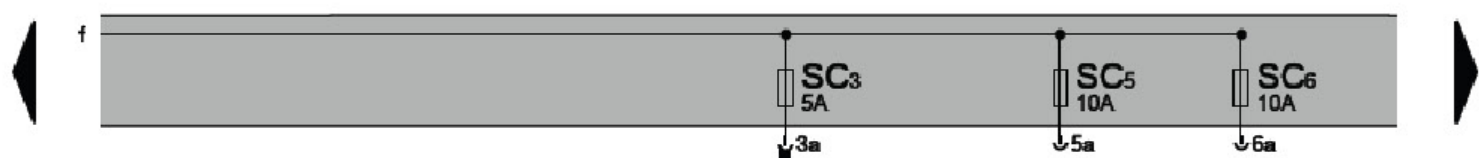

- liw = 橘黄色
- ws = 白色
- ro = 红色
- gn = 绿色
- gr = 灰色
- ge = 黄色
- rs = 粉红色

239 240 241 242 243 244 245 246 247 248 249 250 251 252  
 1K2-171190806