

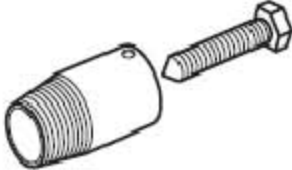



3. 专用工具

说明	图示
气门弹簧压缩工具	 T10005
气门油封拆卸钳	 T10006
铰刀	 T10034
凸轮轴油封安装工具	 T10013
凸轮轴油封安装工具	 T10015

<p>平缸保持卡具</p>	 <p>T10018</p>
<p>曲轴前油封安装工具</p>	 <p>T10032</p>
<p>活塞安装工具</p>	 <p>T10016</p>
<p>曲轴后油封更换工具</p>	 <p>T10033</p>
<p>曲轴前油封拆卸工具（小帽件）</p>	 <p>T10025</p>

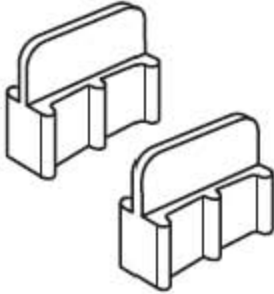
曲轴前油封拆卸工具	 <p>T10031</p>
飞轮锁止工具	 <p>T10028</p>
正时齿轮锁止工具	 <p>T10029</p>
正时齿轮固定工具	 <p>T10030</p>
凸轮轴油封拆卸工具	 <p>T10022</p>

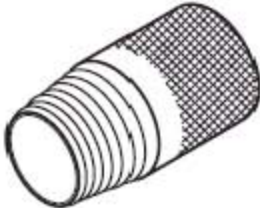
凸轮轴前油封拆卸螺栓	 T10023
发动机机油压力表	 T10001
发动机右液压悬置安装工具	 T10027
离合器液压管分解叉	 T22002
球头拆卸夹具	 T38008

下摆臂球头扩张器	 T32020
下摆臂球头分离杠杆	 T32011
下摆臂球头保护罩	 T32003
驱动轴拆卸工具	 T30001
发动机维修起吊支架	 T10007

举升支架

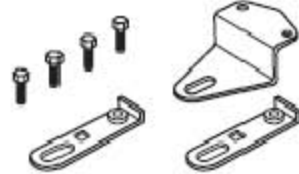

T10035

LAUNCH