

### 2.4 接地

## G100, G101

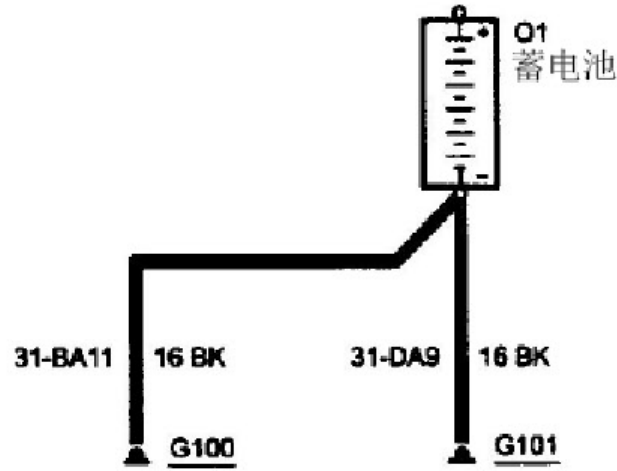

## G102, 汽油发动机

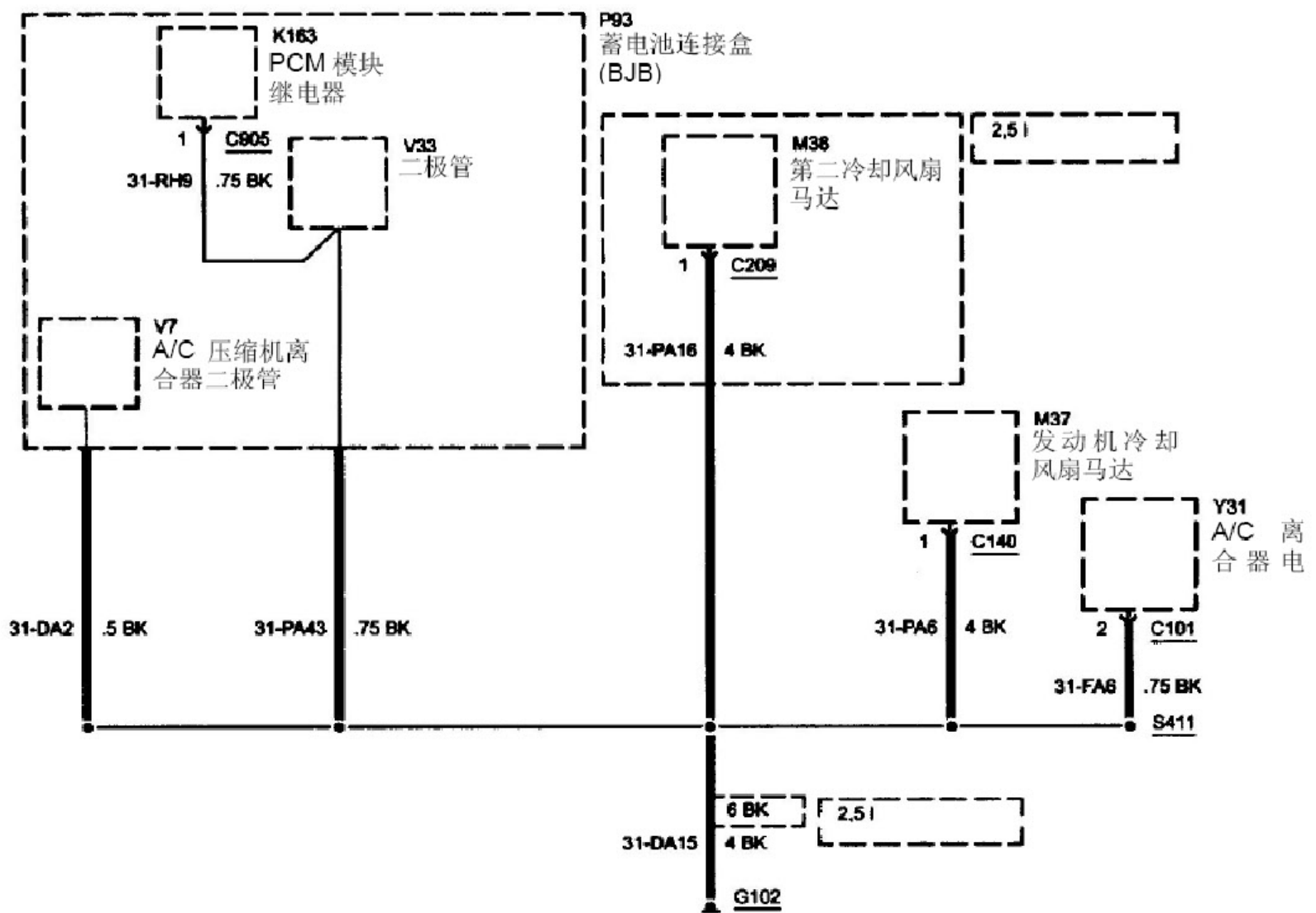

### G102, 2.0 I 柴油发动机

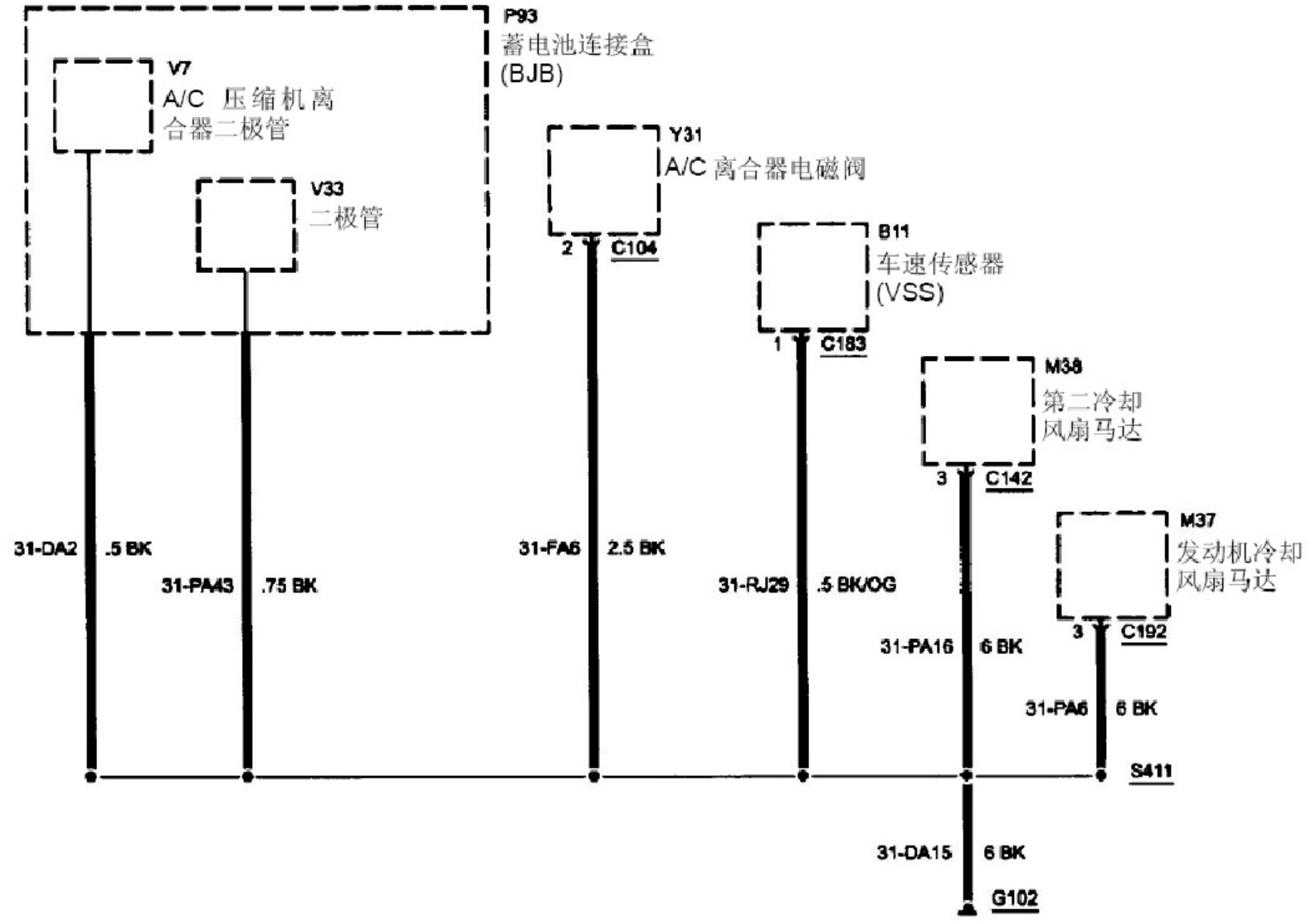

### G103

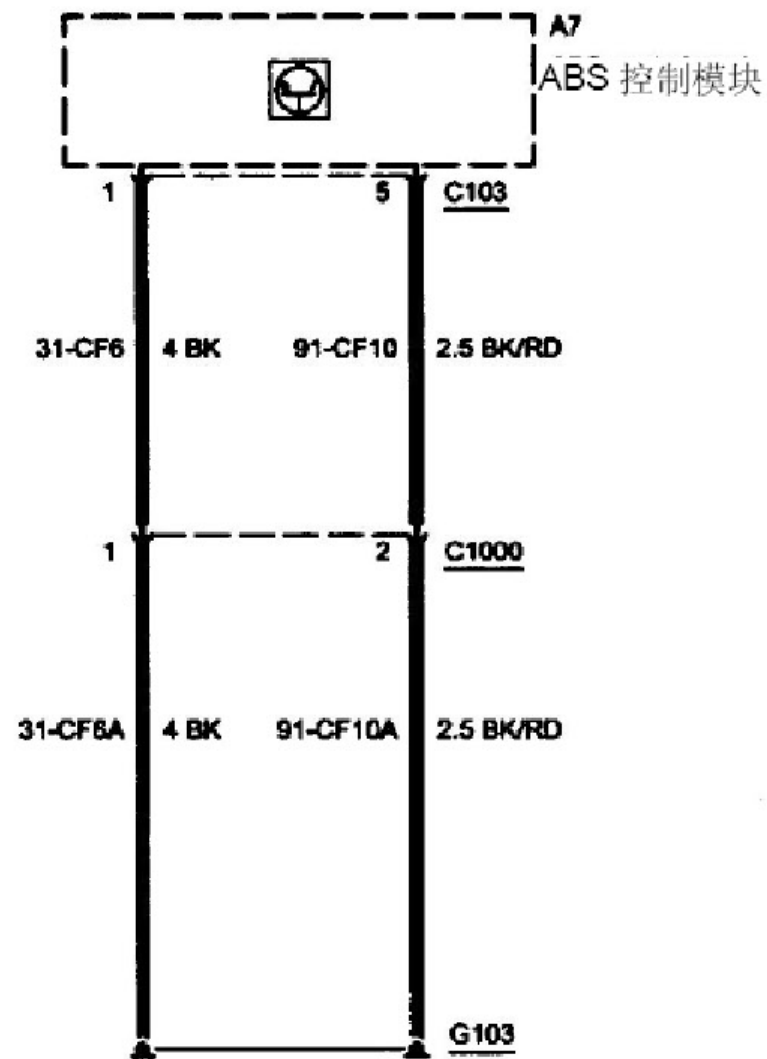

# G104

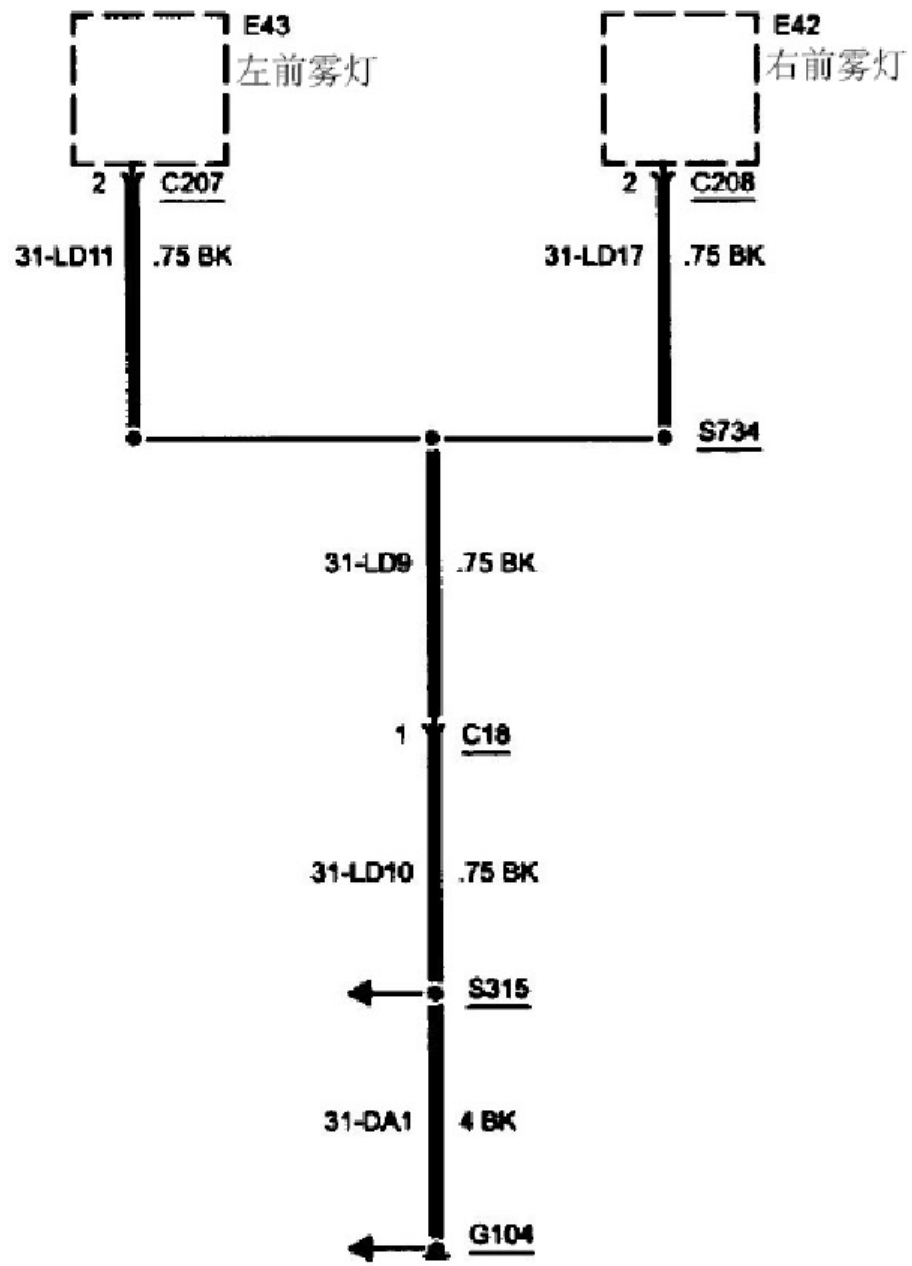

LAUNCH

### G104, 配备氙气前照灯

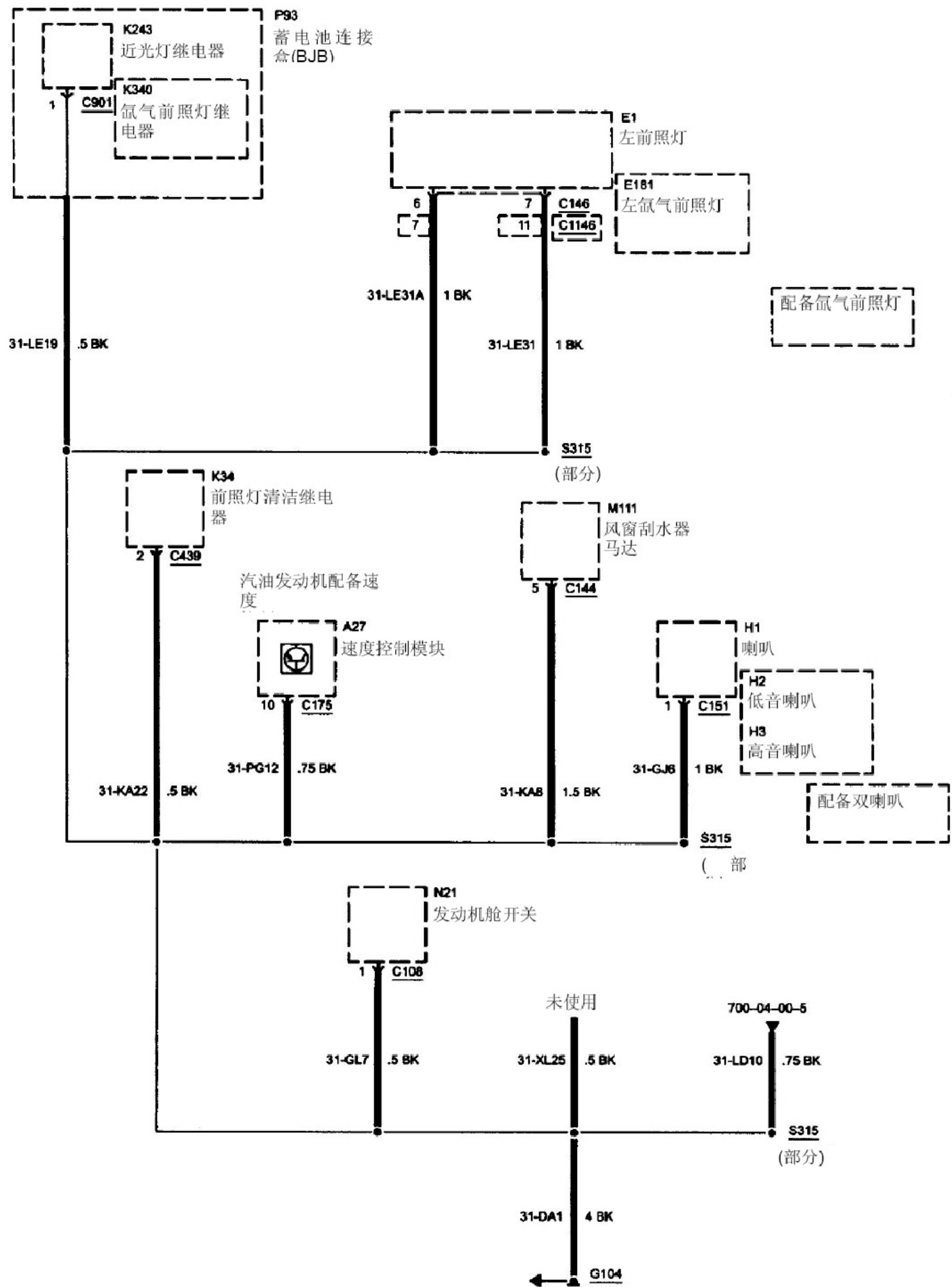

# G104

2.0 I 柴油发动机配  
备燃油式进气加热  
器

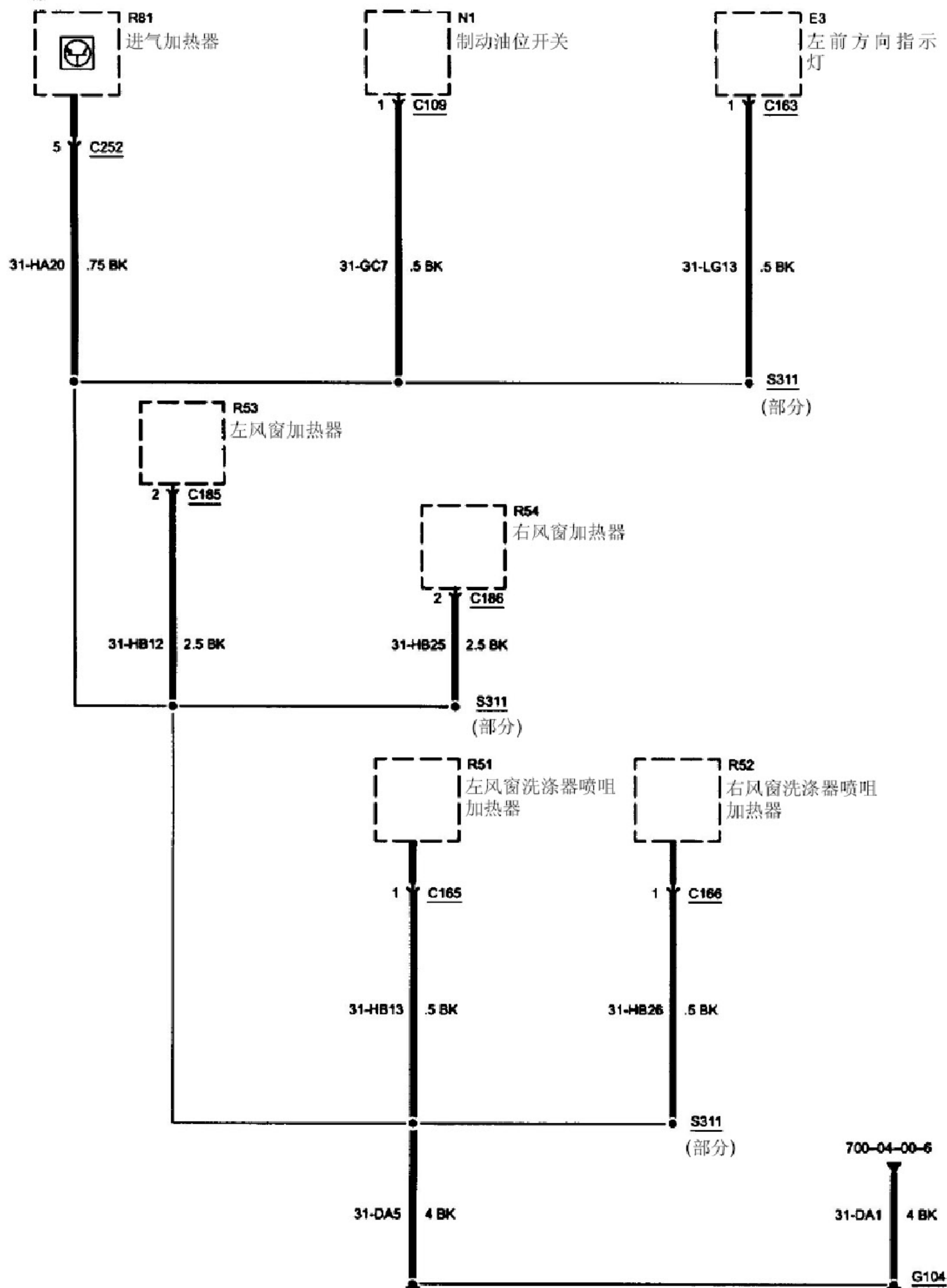

# G105

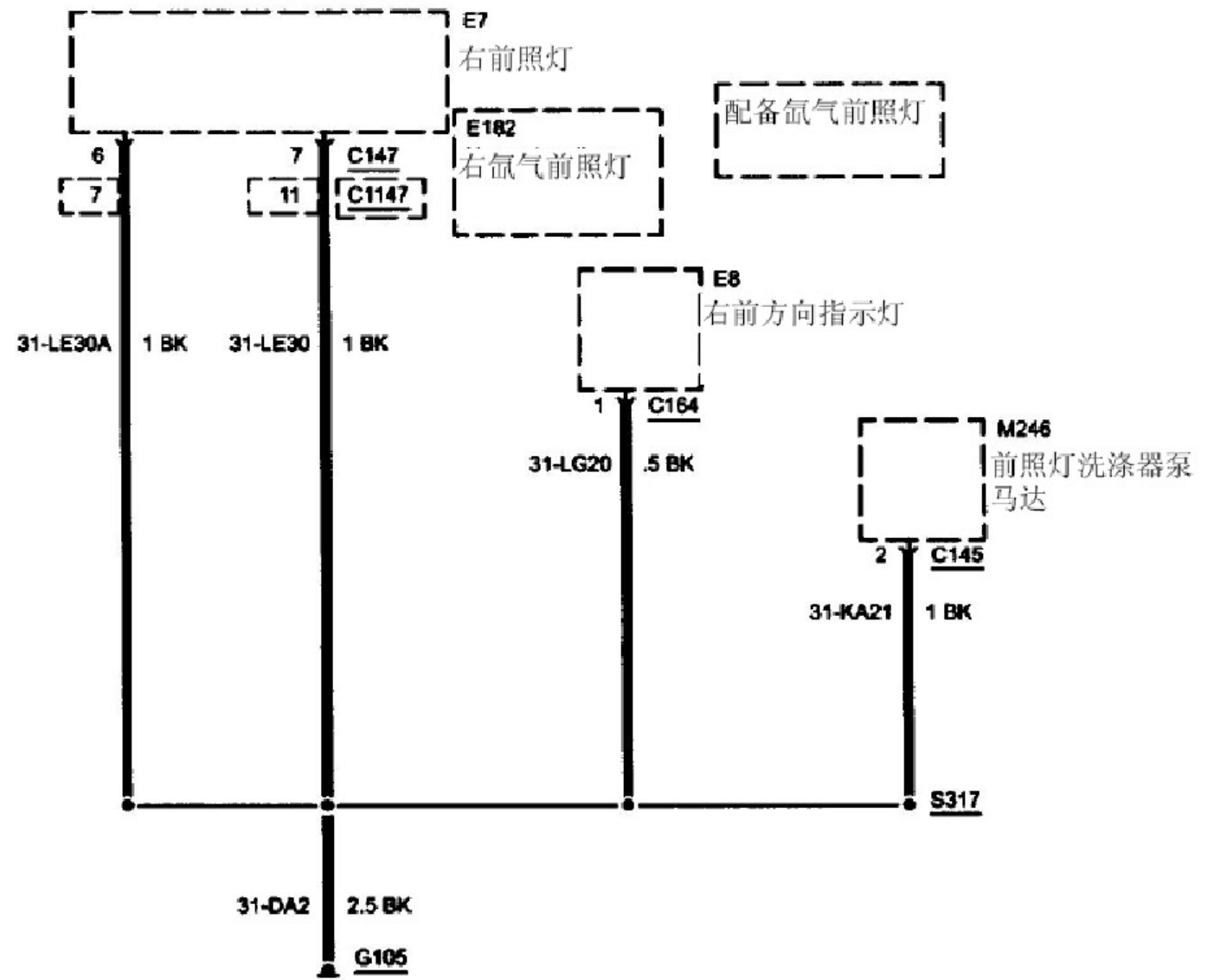

LAUNCH

G106, 1,8 I 与 2,0 I

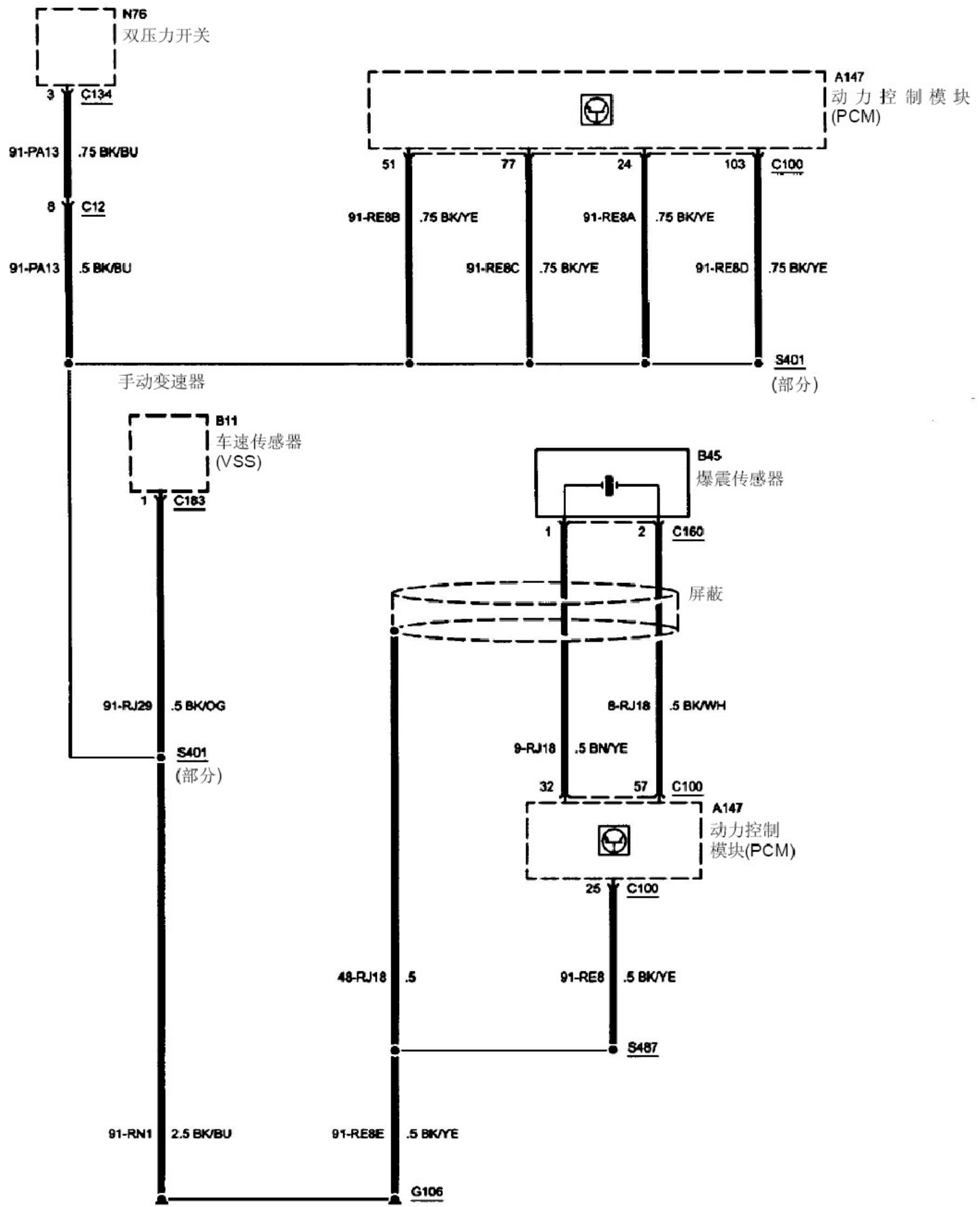

# G106, 2,5 I

