

2.2 保险丝和继电器信息

保险丝和继电器信息—中央接线盒 (CJB), 前端

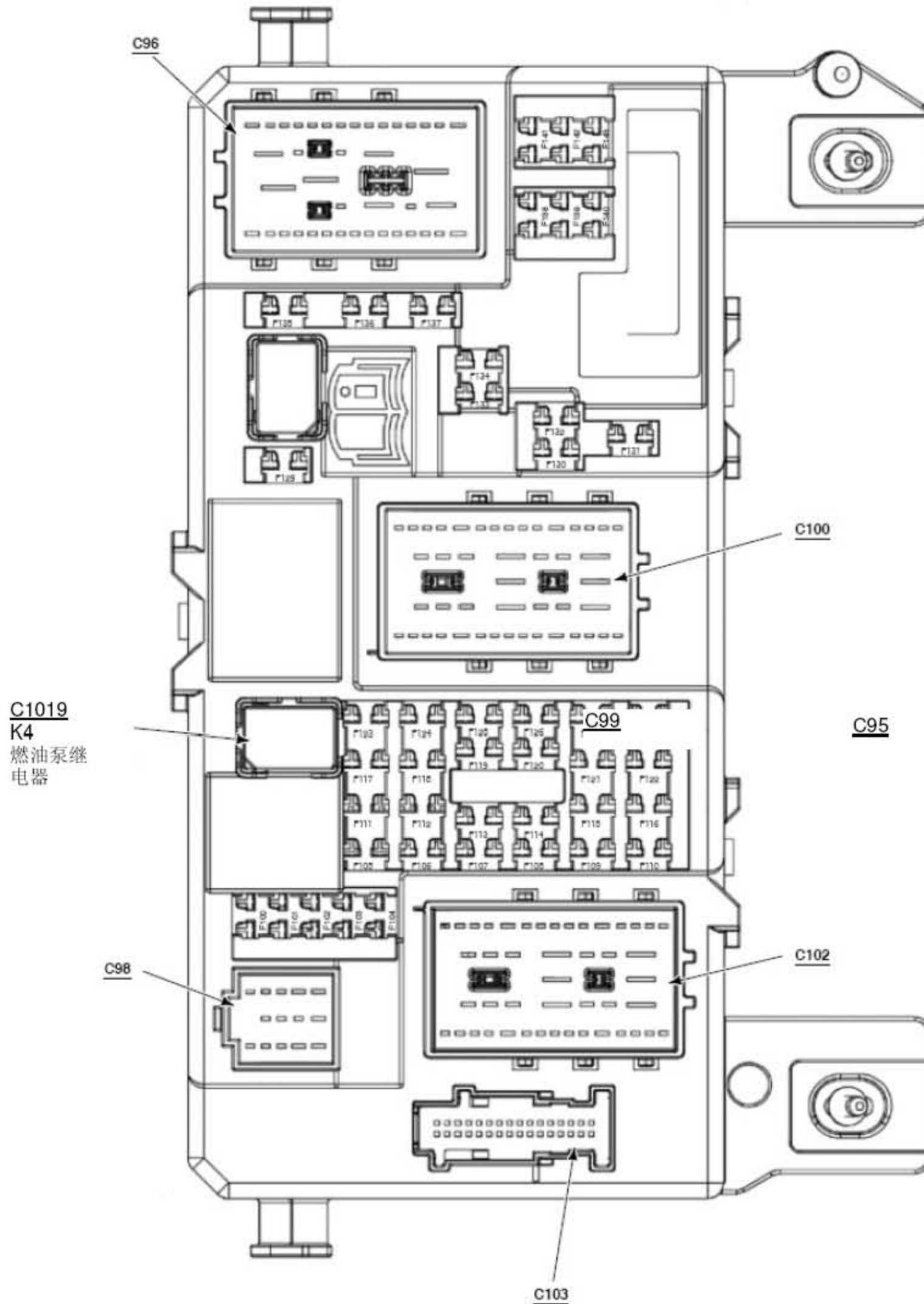

保险丝和继电器信息—中央接线盒 (CJB), 后端

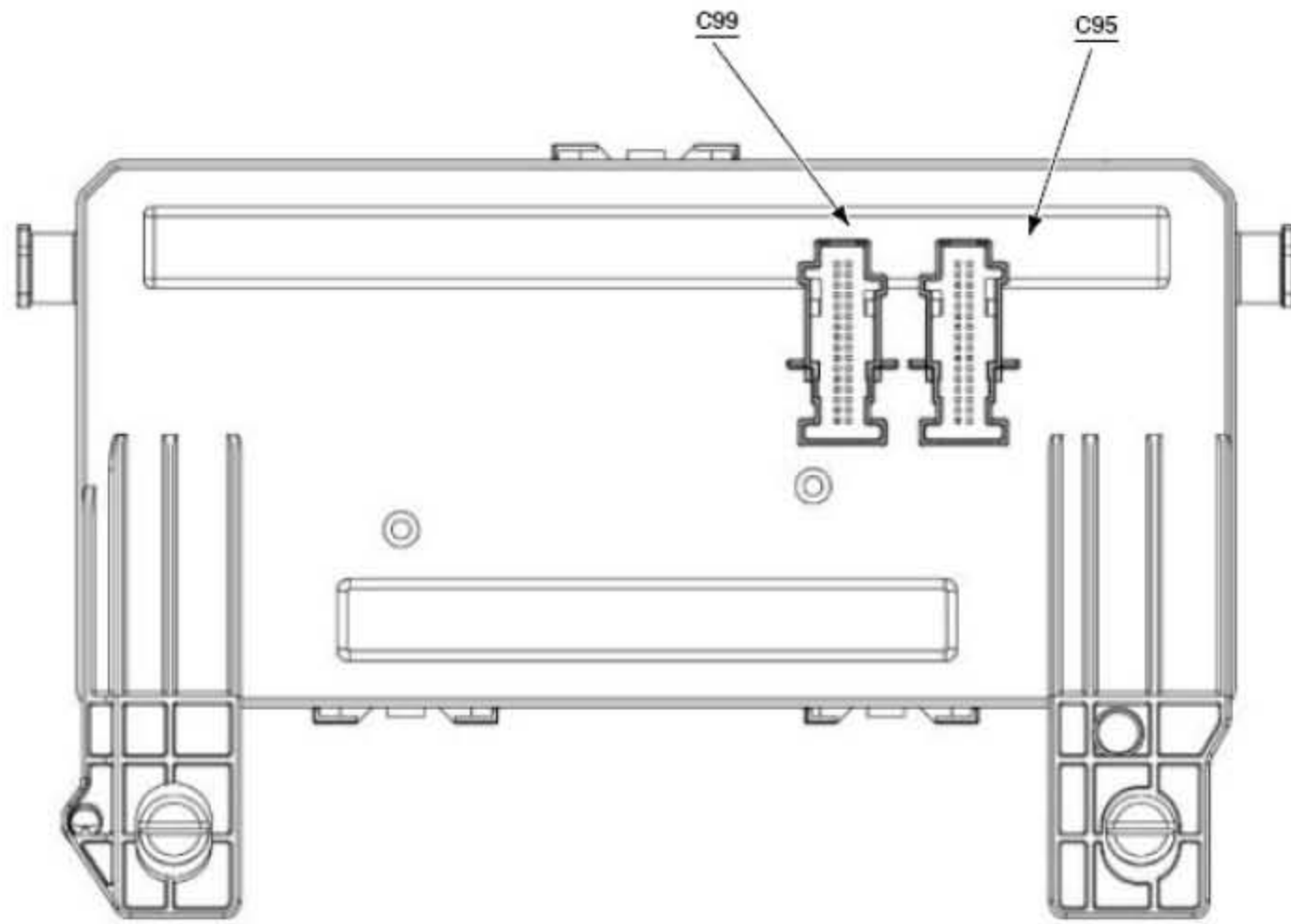

保险丝和继电器信息—蓄电池接线盒 (BJB)

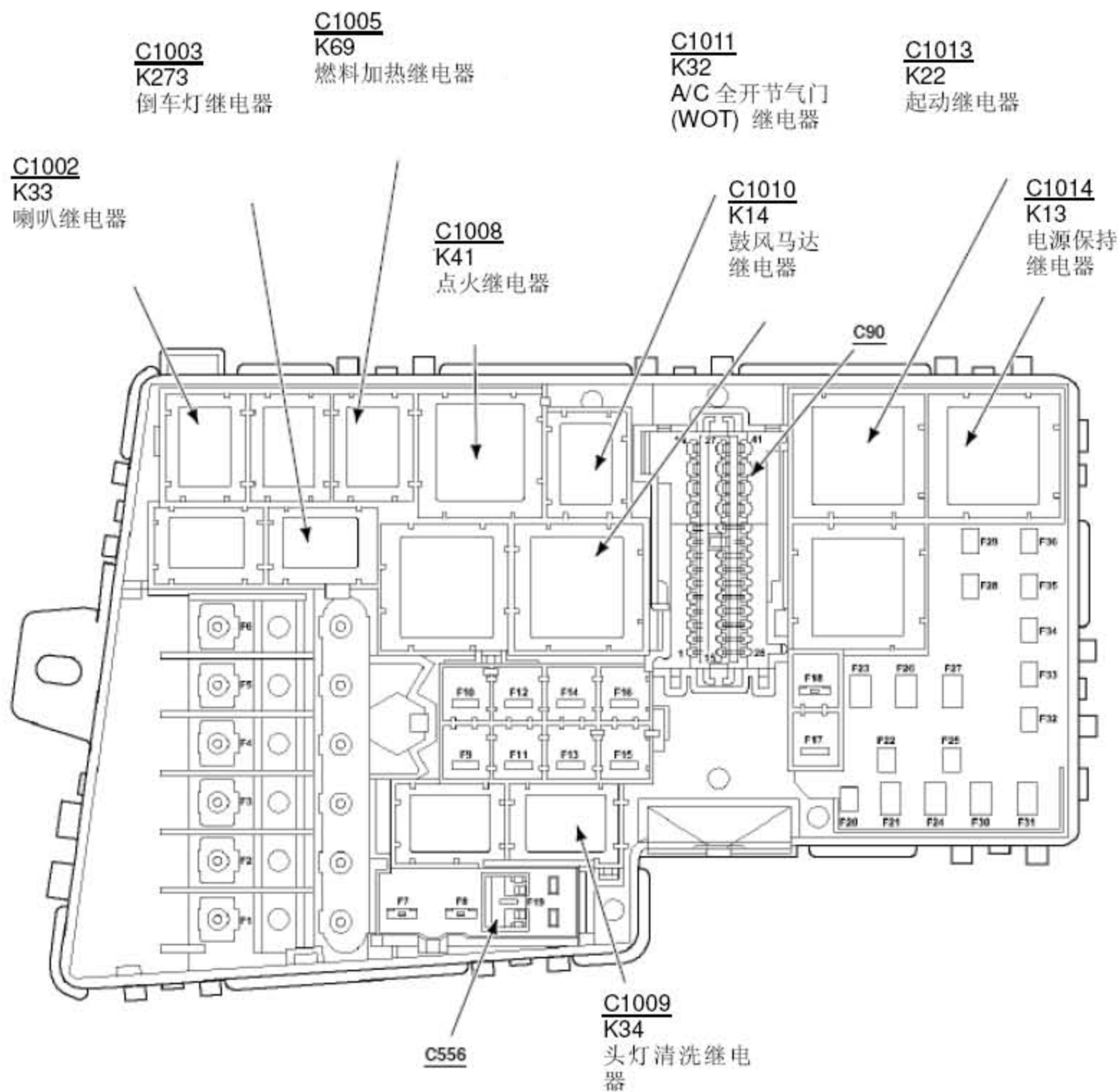

中央接线盒 (CJB)

章节	说明	保险丝号码																	
		100	101	102	103	104	105	106	107	108	109	110	111	112	113	114	115	116	117
		10A	20A	10A	10A	10A	20A	20A	10A	7.5A	20A	10A	15A	15A	10A	10A	7.5A	20A	7.5A
208-09A-00	防抱死控制																		
208-09C-00	防抱死控制-稳定辅助																		
211-02-00	动力转向																		
303-03A-00	发动机冷却-1.6L (Z6)																		
303-03B-00	发动机冷却-1.8/2.0L Duratec-HE (MI4)																		
303-03C-00	发动机冷却-2.0L Duratec-TDCi (DW) 柴油																		
303-04A-00	燃油增压和控制-1.6L (Z6)																		
303-04B-00	燃油增压和控制-1.8/2.0 L Duratec-HE(MI4)																		
303-04C-00	燃油增压和控制-2.0L Duratec-TDCi (DW) 柴油																		
303-06A-00	起动系统-1.6L (Z6)																		
303-06B-00	起动系统-1.8/2.0 L Duratec-HE(MI4)																		
303-06C-00	起动系统-2.0L Duratec-TDCi (DW) 柴油																		
303-07A-00	发动机点火-1.6L (Z6)																		
303-07B-00	预热塞系统-1.8/2.0 L Duratec-HE(MI4)																		
303-07C-00	预热塞系统-2.0L Duratec-TDCi (DW) 柴油																		
303-14A-00	电子发动机控制-1.6L (Z6)																		
303-14B-00	电子发动机控制-1.8/2.0L Duratec-HE (MI4)												●						
303-14C-00	电子发动机控制-2.0L Duratec-TDCi (DW) 柴油	●	●																
307-01-00	自动变速器	●																	
308-00-00	手动变速器	●																	
310-03-00	车速控制							●											
412-02A-00	采暖与通风	●	●					●											
412-03-00	冷气	●	●					●											
413-00-00	组合仪表与面板照明	●		●			●									●			
413-01-00	组合仪表			●			●	●							●				
413-06-00	喇叭																		
413-07-00	时钟							●					●						
413-13-00	驻车辅助	●	●																
414-02A-00	发电机和稳压器-1.6L [®]																		
414-02B-00	发电机和稳压器-1.8/2.0L Duratec-HE (MI4)																		
414-02C-00	发电机和稳压器-2.0L Duratec-TDCi (DW) 柴油																		
415-01-00	音响单元							●					●						
415-03-00	扬声器																		
417-01-00	外部照明			●			●								●	●	●	●	
417-02-00	内部照明				●		●												
418-00-00	模块通信网络							●											
419-01A-00	防盗-主动式																		
419-01B-00	防盗-被动式							●	●						●				
419-10-00	多功能电子控制模块							●				●		●				●	

中央接线盒 (CJB)

章节	说明	保险丝号码																	
		118	119	120	121	122	123	124	125	126	127	128	131	132	133	134	135	135	
		20A	25A	20A	20A	10A	7.5A	7.5A	7.5A	20A	25A	20A	15A	15A	20A	20A	20A	15A	
206-C9A-00	防抱死控制													●					
206-C9C-00	防抱死控制—稳定辅助													●					
211-02-00	动力转向																		
303-C3A-00	发动机冷却—1.6L (Z6)																		
303-C3B-00	发动机冷却—1.8/2.0L Duratec—HE (MI4)																		
303-C3C-00	发动机冷却—2.0L Duratec—TDCi (DW) 柴油																		
303-C4A-00	燃油增压和控制—1.6L (Z6)																		
303-C4B-00	燃油增压和控制—1.8/2.0 L Duratec-HE(MI4)																		
303-C4C-00	燃油增压和控制—2.0L Duratec—TDCi (DW) 柴油																		
303-C6A-00	起动系统—1.6L (Z6)																		
303-C6B-00	起动系统—1.8/2.0 L Duratec-HE(MI4)																		
303-C6C-00	起动系统—2.0L Duratec—TDCi (DW) 柴油																		
303-C7A-00	发动机点火—1.6L (Z6)																		
303-C7B-00	预热塞系统—1.8/2.0 L Duratec-HE(MI4)																		
303-C7C-00	预热塞系统—2.0L Duratec—TDCi (DW) 柴油																		
303-14A-00	电子发动机控制—1.6L (Z6)																		
303-14B-00	电子发动机控制—1.8/2.0L Duratec—HE (MI4)																		
303-14C-00	电子发动机控制—2.0L Duratec—TDCi (DW) 柴油																		
307-C1-00	自动变速器													●					
308-C0-00	手动变速器													●					
310-C3-00	左速控制																		
412-C2A-00	采暖与通风																		
412-C3-00	冷气																		
413-C0-00	组合仪表和面板照明	●	●							●						●			
413-C1-00	组合仪表																		
413-C6-00	喇叭																		
413-C7-00	时钟																		
413-13-00	驻车辅助																		
414-C2A-00	发电机和稳压器—1.6L ^{Z6}																		
414-C2B-00	发电机和稳压器—1.8/2.0L Duratec—HE (MI4)																		
414-C2C-00	发电机和稳压器—2.0L Duratec—TDCi (DW) 柴油																		
415-C1-00	音响单元																		
415-C3-00	扬声器																		
417-C1-00	外部照明							●	●					●		●	●		
417-C2-00	内部照明																●		
418-C0-00	模块通信网络																		
419-C1A-00	防盗—主动式																		
419-C1B-00	防盗—被动式																		
419-10-00	多功能电子控制模块																		

中央接线盒 (CJB)

章节	说明	保险丝号码																	
		100	101	102	103	104	105	106	107	108	109	110	111	112	113	114	115	116	117
		10A	20A	10A	10A	10A	25A	20A	10A	7.5A	20A	10A	15A	15A	10A	10A	7.5A	20A	7.5A
501-09-00	后视镜																		
501-10-00	座椅																		
501-11-00	玻璃, 窗框与机构																		
501-12-00	仪表板与中控台																		
501-14-00	把手, 锁, 开锁和进入系统																		
501-16-00	雨刷与清洗器																		
501-17-00	天窗开启面板																		
501-20A-00	安全带系统																		
501-20B-00	辅助约束系统																		

中央接线盒 (CJB)

章节	说明	保险丝号码																	
		118	119	120	121	122	123	124	125	126	127	129	131	132	133	134	135	136	
		20A	25A	20A	20A	10A	7.5A	7.5A	7.5A	20A	25A	20A	15A	15A	25A	20A	20A	15A	
501-09-00	后视镜																		
501-10-00	座椅																		
501-11-00	玻璃, 窗框与机构																		
501-12-00	仪表板与中控台																		
501-14-00	把手, 锁, 开锁与进入系统																		
501-16-00	雨刷与清洗器																		
501-17-00	天窗开启面板																		
501-20A-00	安全带系统																		
501-20B-00	辅助约束系统																		

中央接线盒 (CJB)

章节	说明	保险丝号码																	
		137	138	139	140	141	142	143											
		10A	10A	10A	10A	10A	15A	15A											
501-09-00	后视镜																		
501-10-00	座椅																		
501-11-00	玻璃, 窗框与机构																		
501-12-00	仪表板与中控台																		
501-14-00	把手, 锁, 开锁与进入系统																		
501-16-00	雨刷与清洗器																		
501-17-00	天窗开启面板																		
501-20A-00	安全带系统																		
501-20B-00	辅助约束系统																		

蓄电池接线盒 (BJB)

章节	说明	保险丝号码																
		1 80A	2 80A	3 80A	4 80A	5 80A	6 30A	7 30A	8 20A	9 20A	10 30A	11 20A	12 40A	13 20A	14 40A	15 30A	16 40A	17 30A
206-09A-00	防抱死控制							●	●									
206-09C-00	防抱死控制—稳定辅助							●	●									
211-02-00	动力转向		●															
303-03A-00	发动机冷却—1.6L (Z6)	●															●	
303-03B-00	发动机冷却—1.8/2.0L Duratec—HE (M14)	●																
303-03C-00	发动机冷却—2.0L Duratec—TDCi (DW) 柴油	●																
303-04A-00	燃油增压和控制—1.6L (Z6) ¹																	
303-04B-00	燃油增压和控制—1.8/2.0 L Duratec-HE(M14)																	
303-04C-00	燃油增压和控制—2.0L Duratec—TDCi (DW) 柴油																	
303-06A-00	起动系统—1.6L (Z6)												●		●			
303-06B-00	起动系统—1.8/2.0 L Duratec-HE(M14)												●		●			
303-06C-00	起动系统—2.0L Duratec—TDCi (DW) 柴油												●		●			
303-07A-00	发动机点火—1.6L (Z6)																	
303-07B-00	预热塞系统—1.8/2.0 L Duratec-HE(M14)																	
303-07C-00	预热塞系统—2.0L Duratec—TDCi (DW) 柴油						●											
303-14A-00	电子发动机控制—1.6L (Z6)										●		●					
303-14B-00	电子发动机控制—1.8/2.0L Duratec—HE (M14)										●		●					
303-14C-00	电子发动机控制—2.0L Duratec—TDCi (DW) 柴油										●		●					
307-01-00	自动变速器												●					
308-00-00	手动变速器												●					
310-03-00	车速控制												●					
412-02A-00	采暖与通风											●	●					
412-03-00	冷气											●	●					
413-00-00	组合仪表和面板照明												●					
413-01-00	组合仪表																	
413-06-00	喇叭																	
413-07-00	时钟																	
413-13-00	驻车辅助																	
414-02A-00	发电机与稳压器—1.6L(Z6)																	
414-02B-00	发电机与稳压器—1.8/2.0L Duratec—HE (M14)																	
414-02C-00	发电机与稳压器—2.0L Duratec—TDCi (DW) 柴油																	
415-01-00	音响单元																	
415-03-00	扬声器																	
417-01-00	外部照明		●															
417-02-00	内部照明																	
418-00-00	模块通信网络																	
419-01A-00	防盗—主动式																	
419-01B-00	防盗—被动式																	
419-10-00	多功能电子控制模块												●					

蓄电池接线盒 (BJB)

章节	说明	保险丝号码																
		19	20	21	22	23	24	25	26	27	28	29	30	31	32	33	34	35
		10A	15A	20A	10A	30A	15A	10A	10A	10A	10A	10A	3A	10A	10A	10A	10A	10A
206-09A-00	防抱死控制	●																
206-09C-00	防抱死控制-稳定辅助	●																
211-02-00	动力转向			●														
303-03A-00	发动机冷却-1.5L (Z6)																	
303-03B-00	发动机冷却-1.8/2.0L Duratec-HE (M14)																	
303-03C-00	发动机冷却-2.0L Duratec-TDCi (DW) 柴油																	
303-04A-00	燃油增压和控制-1.6L (Z6)															●	●	●
303-04B-00	燃油增压和控制-1.8/2.0 L Duratec-HE (M14)																●	
303-04C-00	燃油增压和控制-2.0L Duratec-TDCi (DW) 柴油						●	●									●	●
303-06A-00	起动系统-1.6L (Z6)																	
303-06B-00	起动系统-1.8/2.0 L Duratec-HE (M14)																	
303-06C-00	起动系统-2.0L Duratec-TDCi (DW) 柴油																	
303-07A-00	发动机点火-1.6L (Z6)																●	
303-07D-00	预热塞系统-1.8/2.0 L Duratec-HE (M14)																	●
303-07C-00	预热塞系统-2.0L Duratec-TDCi (DW) 柴油										●							●
303-14A-00	电子发动机控制-1.6L (Z6)															●	●	●
303-14B-00	电子发动机控制-1.8/2.0L Duratec-HE (M14)															●	●	●
303-14C-00	电子发动机控制-2.0L Duratec-TDCi (DW) 柴油															●	●	●
307-01-00	自动变速器																	
308-00-00	手动变速器									●								
210-02-00	车速控制																	
412-02A-00	采暖与通风																	
412-03-00	冷气										●							●
413-00-00	组合仪表和面板照明																	
413-01-00	组合仪表																	
113-06-00	喇叭	●																
113-07-00	时钟																	
413-13-00	驻车辅助																	
414-02A-00	发电机与稳压器-1.6L (Z6)																	
414-02B-00	发电机与稳压器-1.8/2.0L Duratec-HE (M14)																	
414-02C-00	发电机与稳压器-2.0L Duratec-TDCi (DW) 柴油																	
415-01-00	音响单元																	
415-03-00	扬声器																	
417-01-00	外部照明									●								
417-02-00	内部照明																	
418-00-00	模块通信网络																	
113-01A-00	防盗-主动式																	
413-01D-00	防盗-被动式																	
113-10-00	多功能电子控制模块																	

蓄电池接线盒 (BJB)

章节	说明	保险丝号码																	
		1	2	3	4	5	6	7	8	9	10	11	12	13	14	15	16	17	
		30A	30A	30A	30A	30A	30A	30A	20A	20A	20A	30A	20A	40A	20A	40A	30A	40A	30A
501-09-00	后视镜																		
501-10-00	座椅																		
501-11-00	玻璃, 窗框与机构											●							
501-12-00	仪表板与中控台																		
501-14-00	把手, 锁, 开锁与进入系统											●							
501-16-00	雨刷与清洗器		●																
501-17-00	天窗开启面板																		
501-20A-00	安全带系统																		
501-20B-00	辅助约束系统																		
		1	2	3	4	5	6	7	8	9	10	11	12	13	14	15	16	17	
		30A	30A	30A	30A	30A	30A	30A	20A	20A	20A	30A	20A	40A	20A	40A	30A	40A	30A

蓄电池接线盒 (BJB)

章节	说明	保险丝号码																	
		19	20	21	22	23	24	25	26	27	28	29	30	31	32	33	34	35	36
		10A	15A	20A	10A	30A	15A	10A	10A	10A	10A	15A	5A	10A	10A	10A	10A	15A	10A
501-09-00	后视镜																		
501-10-00	座椅																		
501-11-00	玻璃, 窗框与机构																		
501-12-00	仪表板与中控台																		
501-14-00	把手, 锁, 开锁与进入系统																		
501-16-00	雨刷与清洗器																		
501-17-00	天窗开启面板																		
501-20A-00	安全带系统																		
501-20B-00	辅助约束系统																		
		19	20	21	22	23	24	25	26	27	28	29	30	31	32	33	34	35	36
		10A	15A	20A	10A	30A	15A	10A	10A	10A	10A	15A	5A	10A	10A	10A	10A	15A	10A

辅助保险丝

章节	说明	保险丝号码	
		1000	150A
206-09A-00	防抱死控制		
206-00C-00	防抱死控制—稳定辅助		
211-02-00	动力转向		
303-03A-00	发动机冷却—1.6L (Z6)		
303-03R-00	发动机冷却—1.8/2.0L Duratec—HE (M14)		
303-03C-00	发动机冷却—2.0L Duratec—TDCi (DW) 柴油		
303-04A-00	燃油增压和控制—1.6L (Z6)		
303-04B-00	燃油增压和控制—1.8/2.0 L Duratec-HE(M14)		
303-04C-00	燃油增压和控制—2.0L Duratec—TDCi (DW) 柴油		
303-06A-00	起动系统—1.6L (Z6)	●	
303-06B-00	起动系统—1.8/2.0 L Duratec-HE(M14)	●	
303-06C-00	起动系统—2.0L Duratec—TDCi (DW) 柴油	●	
303-07A-00	发动机点火—1.6L (Z6)		
303-07B-00	预热塞系统—1.8/2.0 L Duratec-HE(M14)		
303-07C-00	预热塞系统—2.0L Duratec—TDCi (DW) 柴油		
303-14A-00	电子发动机控制—1.6L (Z6)		
303-14B-00	电子发动机控制—1.8/2.0L Duratec—HE (M14)		
303-14C-00	电子发动机控制—2.0L Duratec—TDCi (DW) 柴油		
307-01-00	自动变速器		
308-00-00	手动变速器		
310-03-00	车速控制		
412-02A-00	采暖与通风		
412-03-00	冷气		
413-00-00	组合仪表和面板照明		
413-01-00	组合仪表		
413-06-00	喇叭		
413-07-00	时钟		
413-13-00	驻车辅助		
414-02A-00	发电机与稳压器—1.6L (Z6)	●	
414-02B-00	发电机与稳压器—1.8/2.0L Duratec—HE (M14)	●	
414-02C-00	发电机与稳压器—2.0L Duratec—TDCi (DW) 柴油	●	
415-01-00	音响单元		
415-03-00	扬声器		
417-01-00	外部照明		
417-02-00	内部照明		
418-00-00	模块通信网络		
419-01A-00	防盗—主动式		
419-01B-00	防盗—被动式		
419-10-00	多功能电子控制模块		
		1000	
		150A	

辅助保险丝

		保险丝号码	
		1000	
		150A	
章节	说明		
501-00-00	后视镜		
501-10-00	座椅		
501-11-00	玻璃, 窗框与机构		
501-12-00	仪表板与中控台		
501-14-00	把手, 锁, 开锁与进入系统		
501-16-00	雨刷与清洗器		
501-17-00	天窗开启面板		
501-20A-00	安全带系统		
501-20B-00	辅助约束系统		
		1000	
		150A	

LAUNCH

保险丝细节—F1, F2

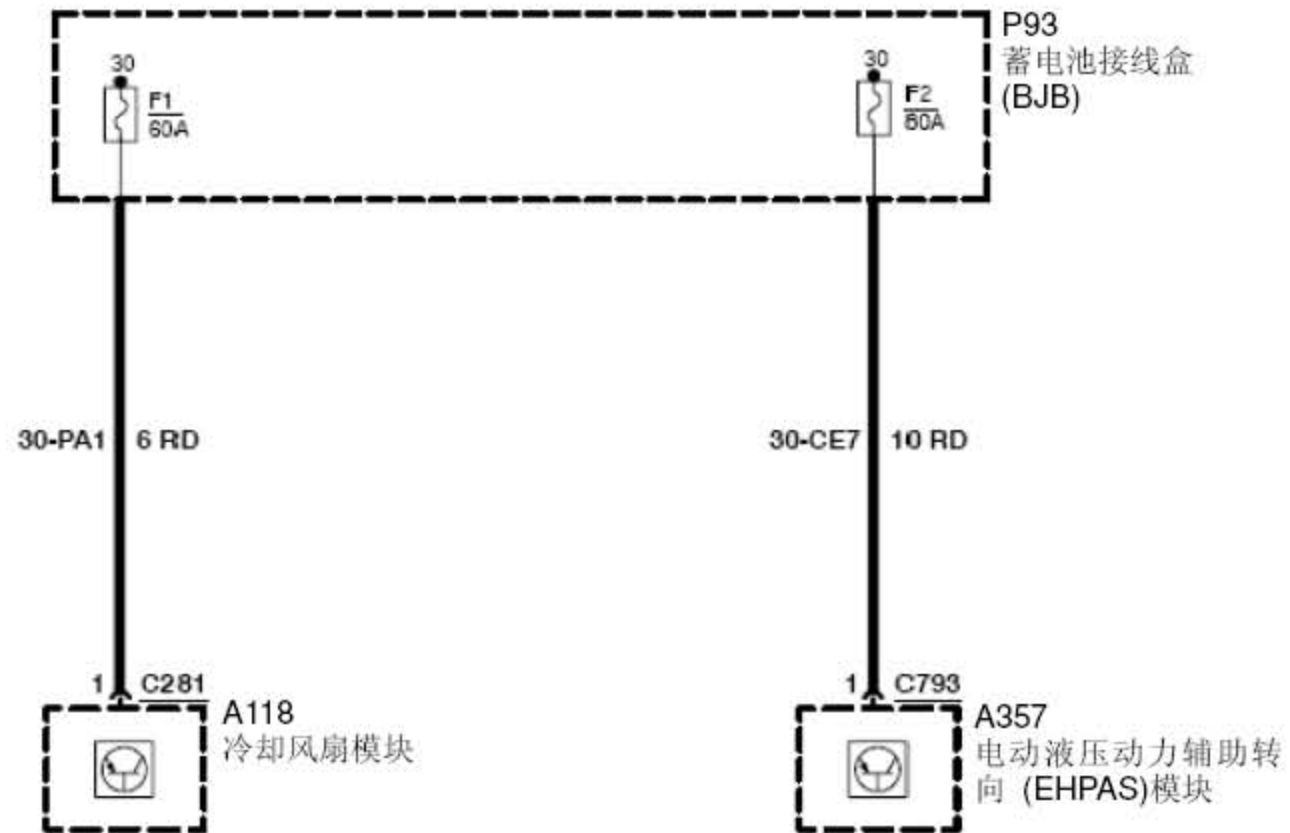

保险丝细节—F3

700-
2

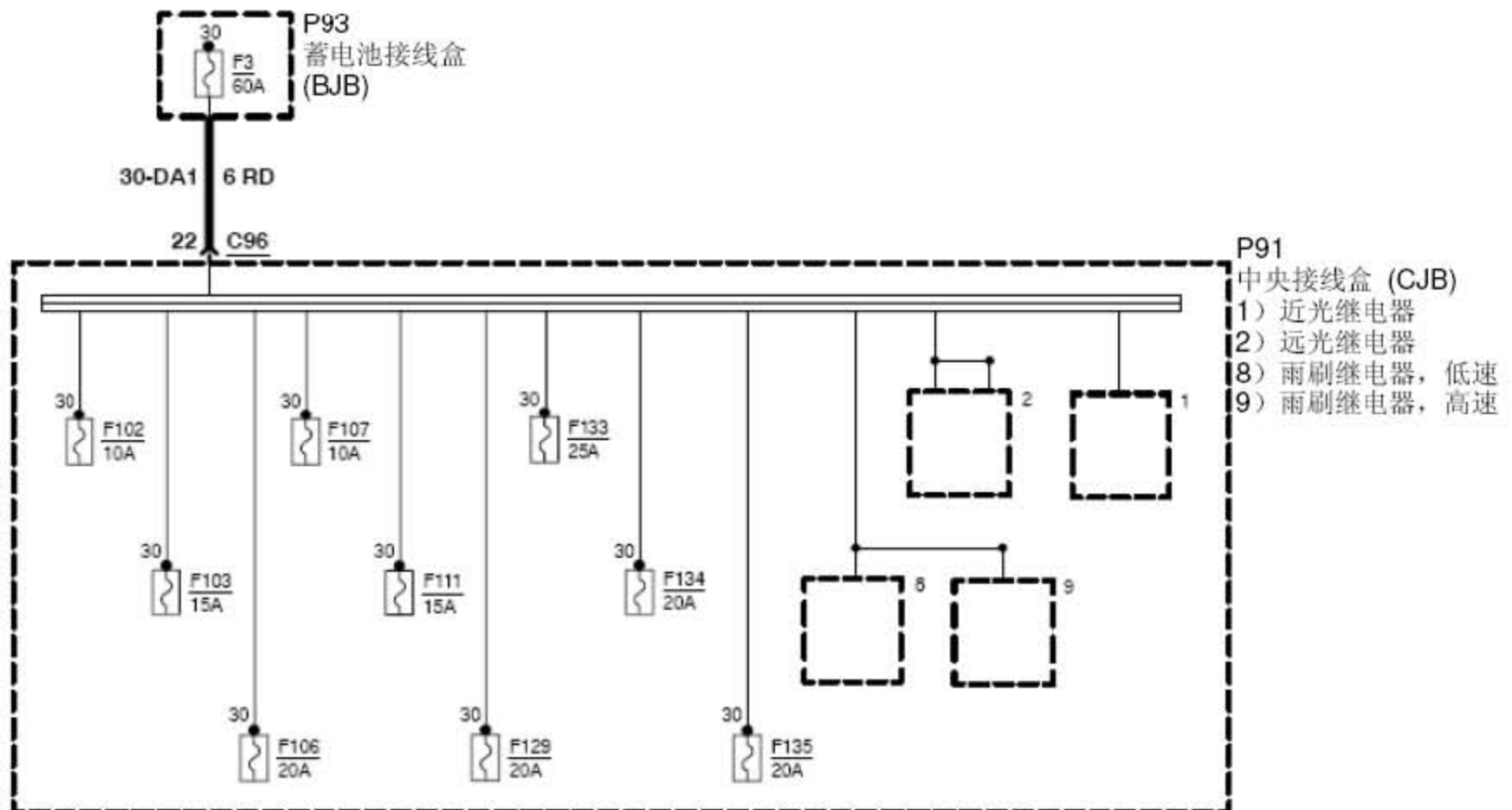

保险丝细节—F4

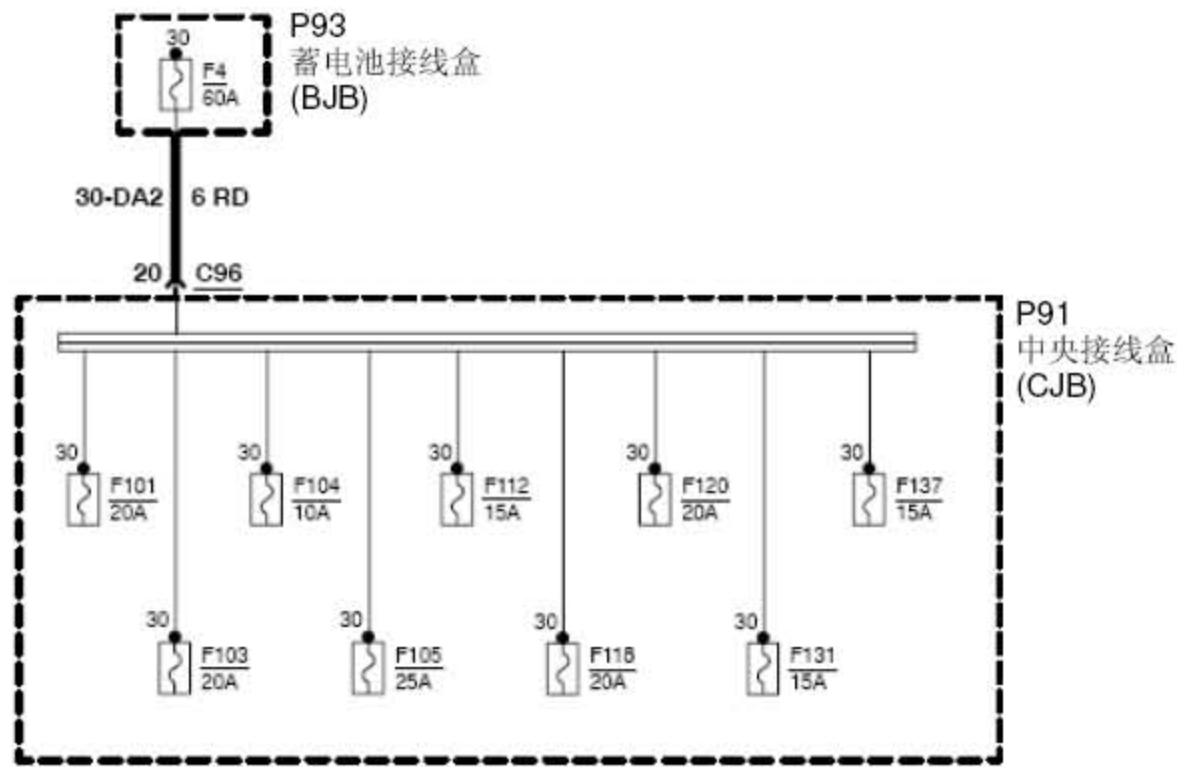

保险丝细节—F6, F7, F8

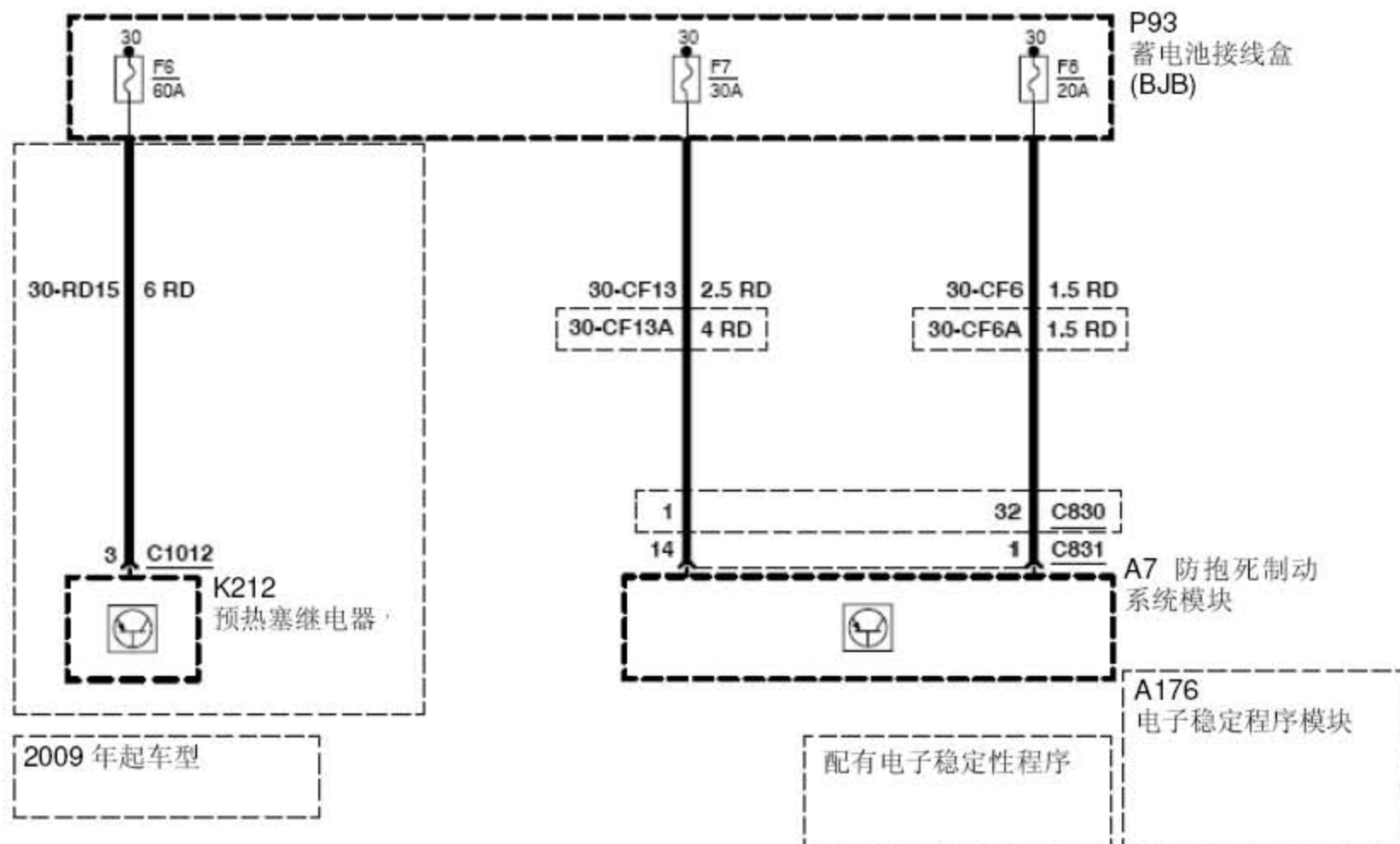

保险丝细节—F9

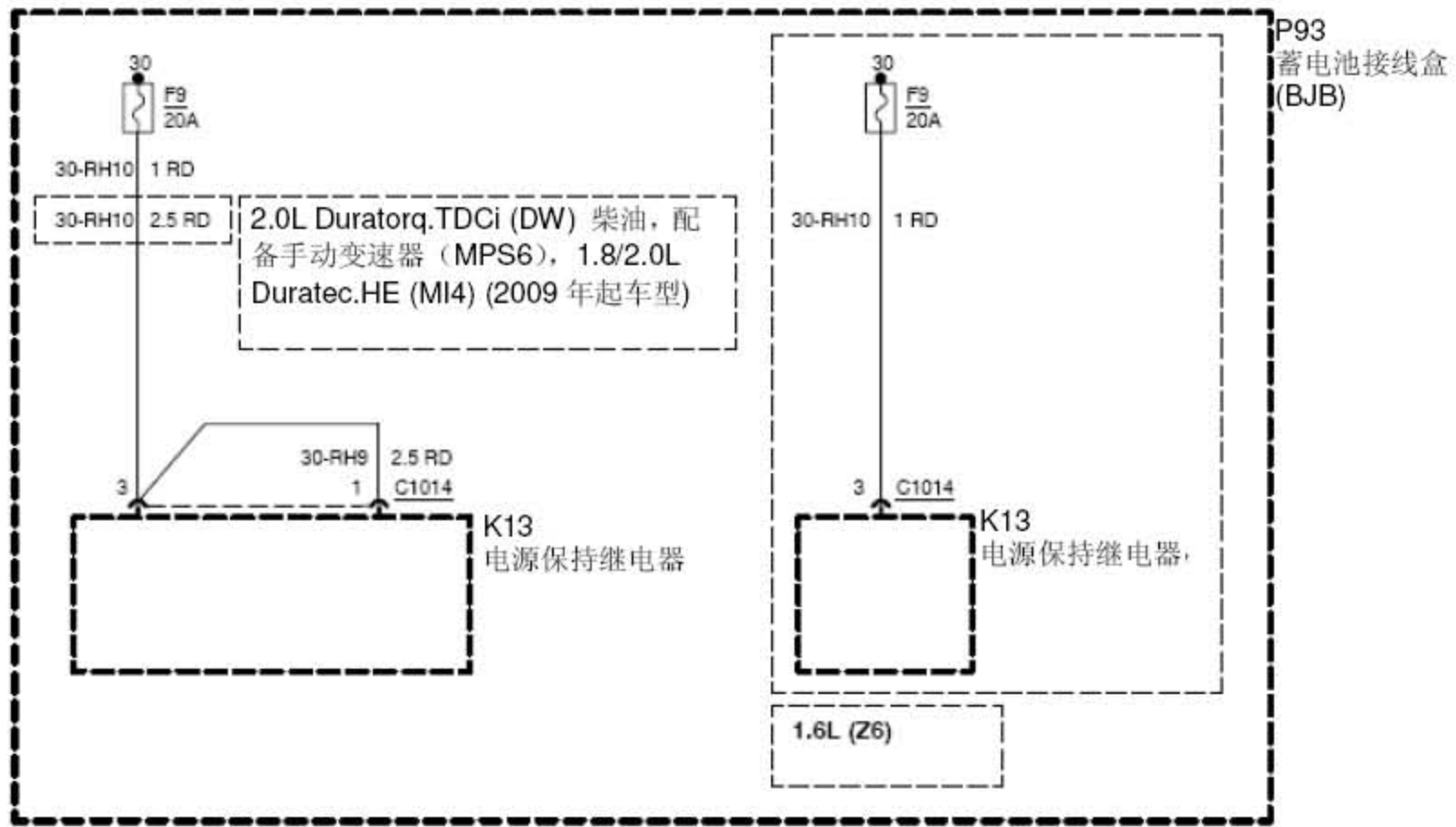

保险丝细节—F10, 2009 年前车型

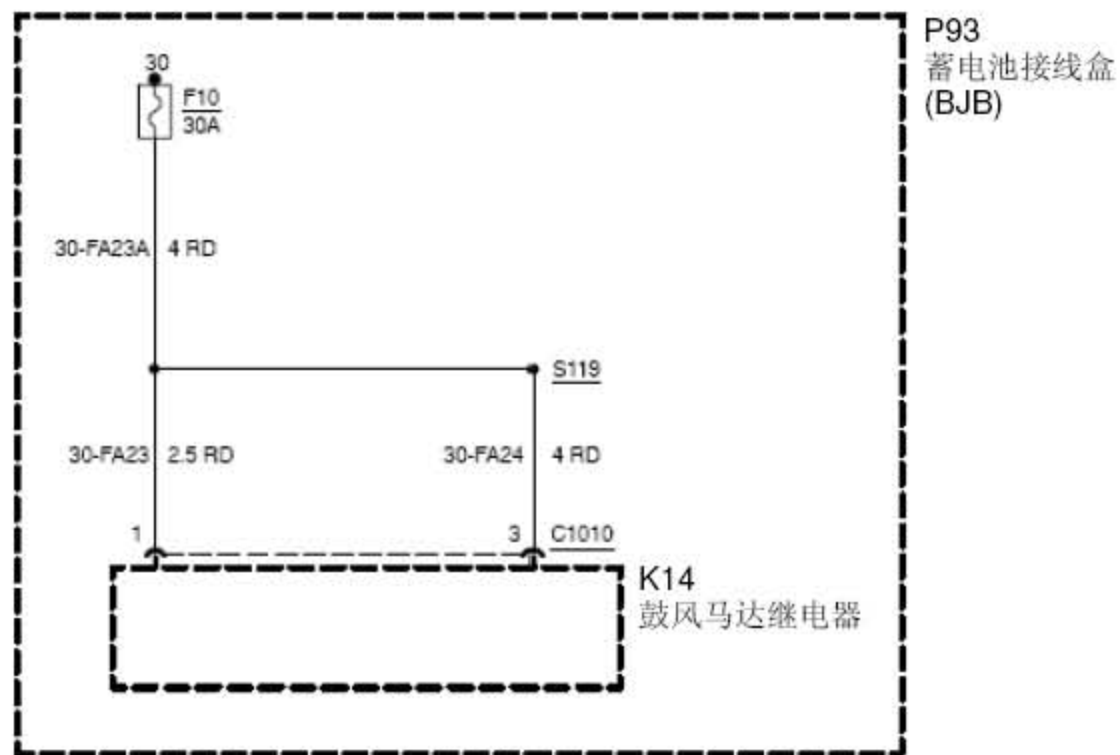

保险丝细节—F10, 2009 年起车型

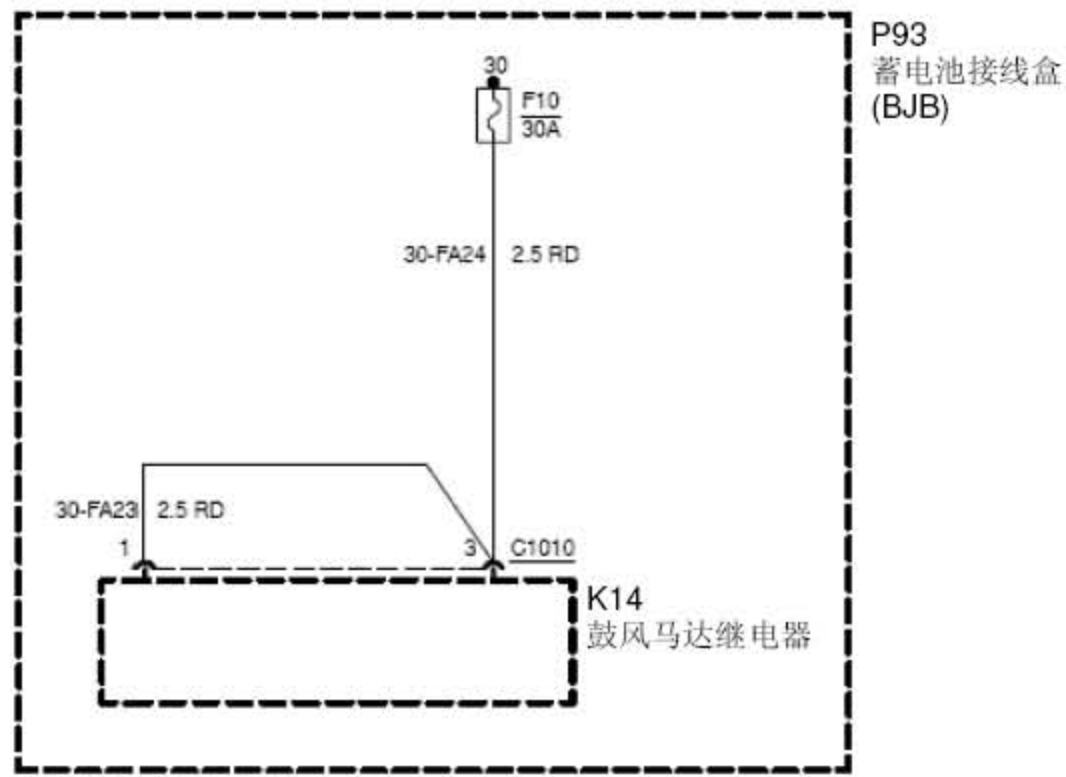

保险丝细节—F11

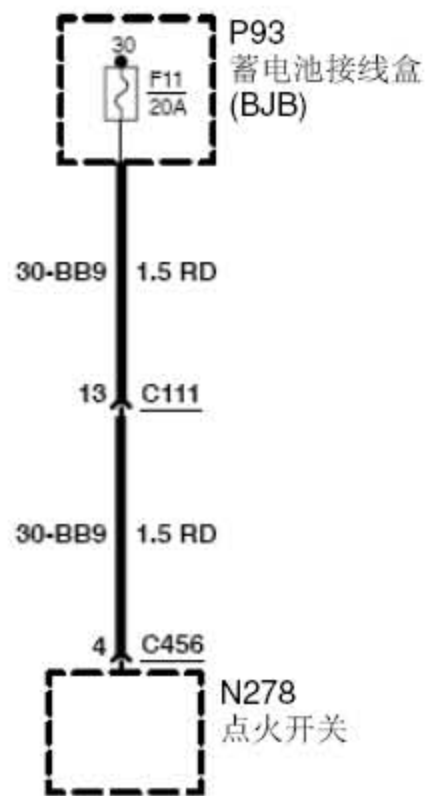

保险丝细节—F12

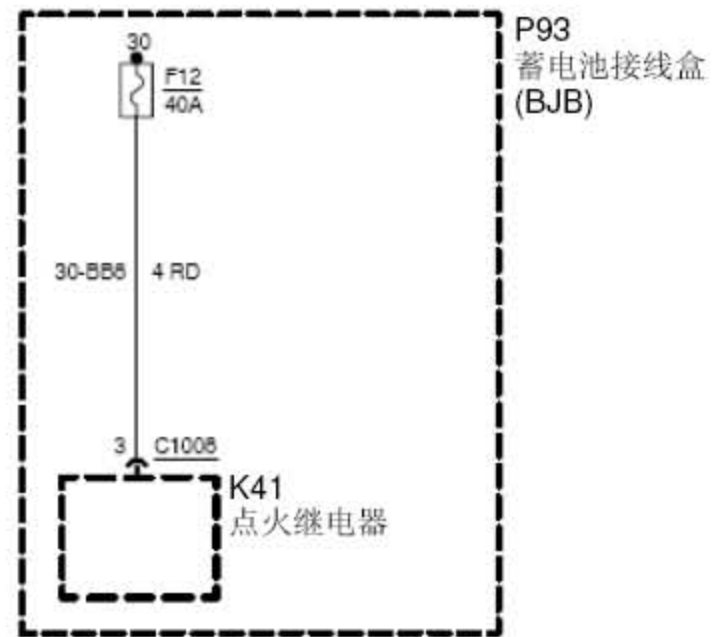

保险丝细节—F13

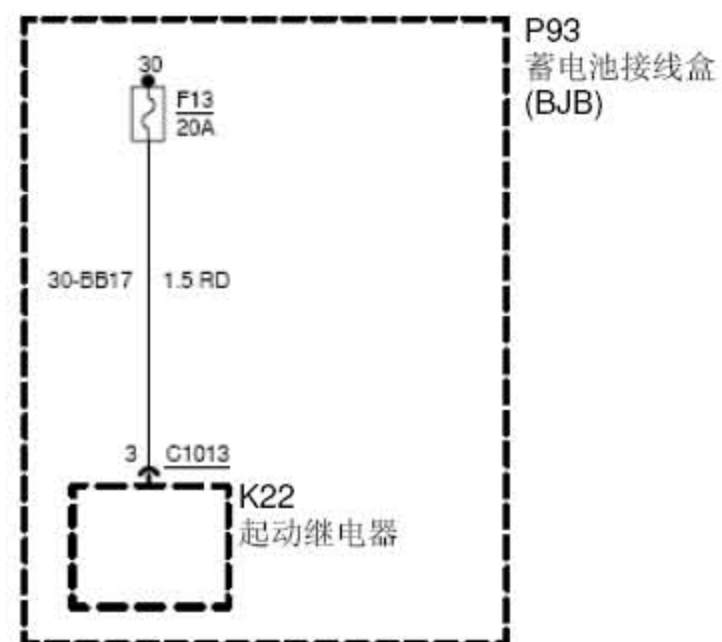

保险丝细节—F19

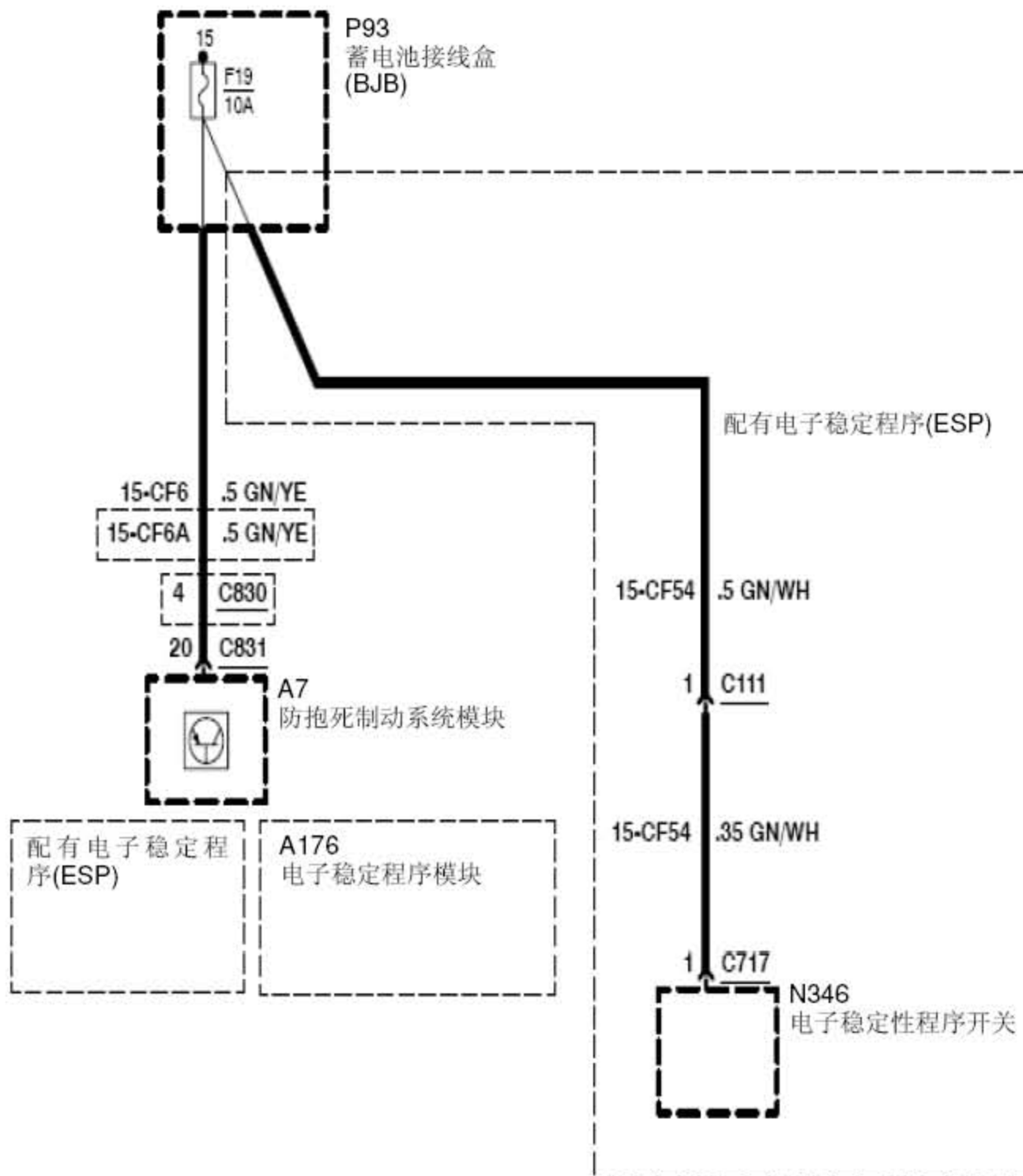

保险丝细节—F20, F22

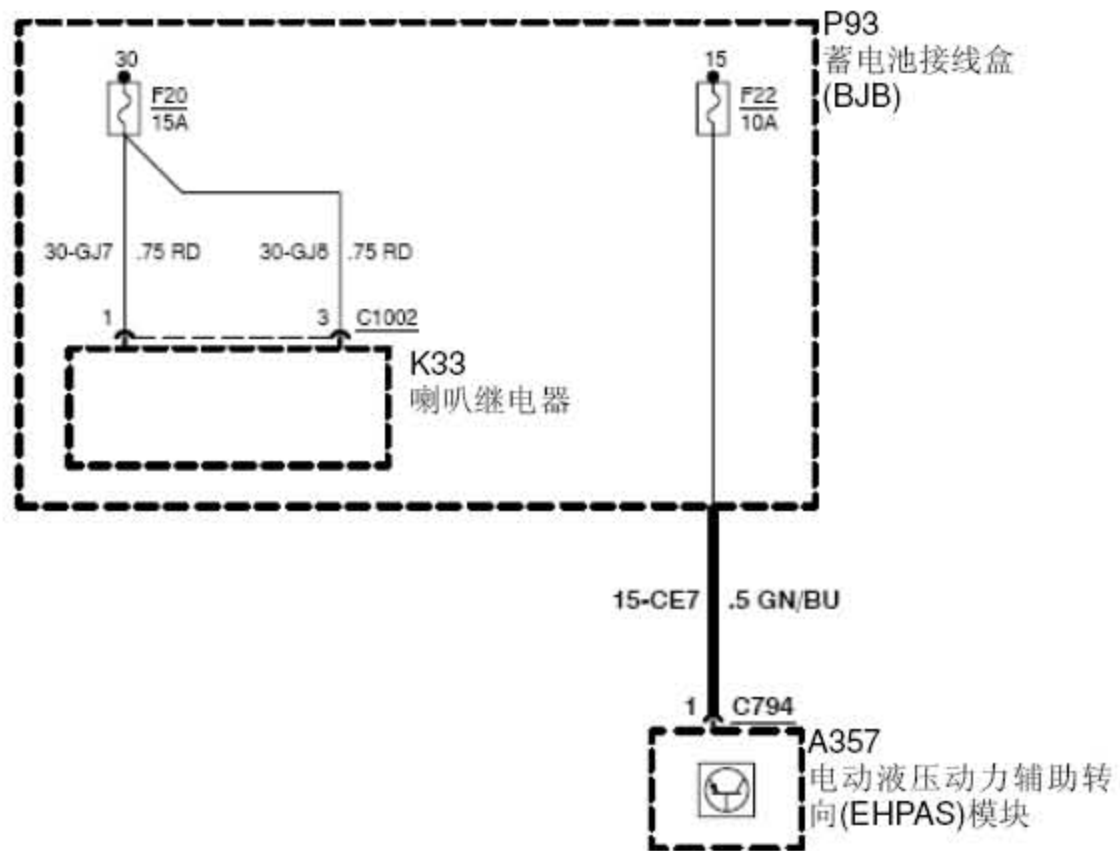

保险丝细节—F24

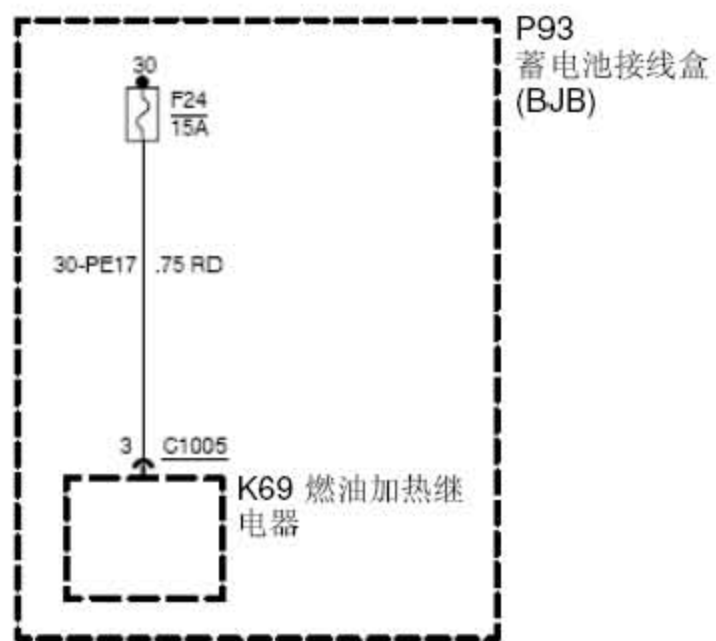

保险丝细节—F25, 不含2.0L Duratorq—TDCi (DW) 柴油手动变速器

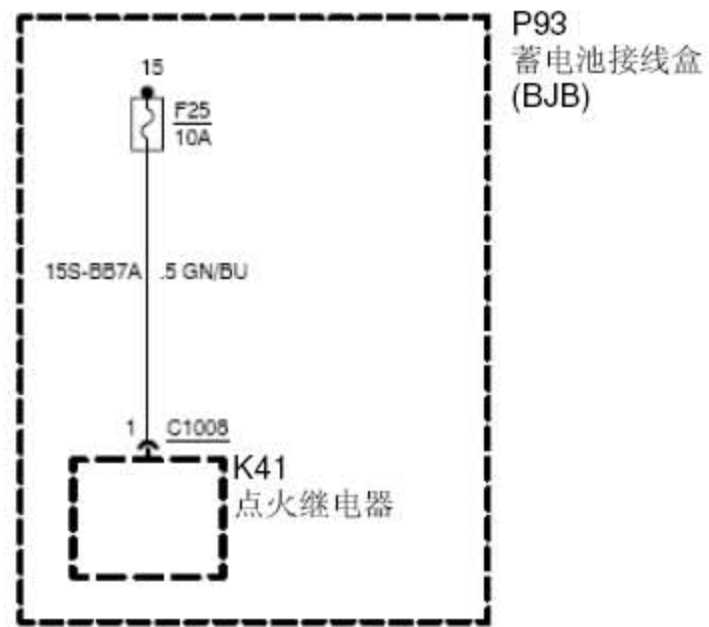

LAUNCH

保险丝细节—F25, 不含2.0L Duratorq—TDCi (DW) 柴油自动变速器

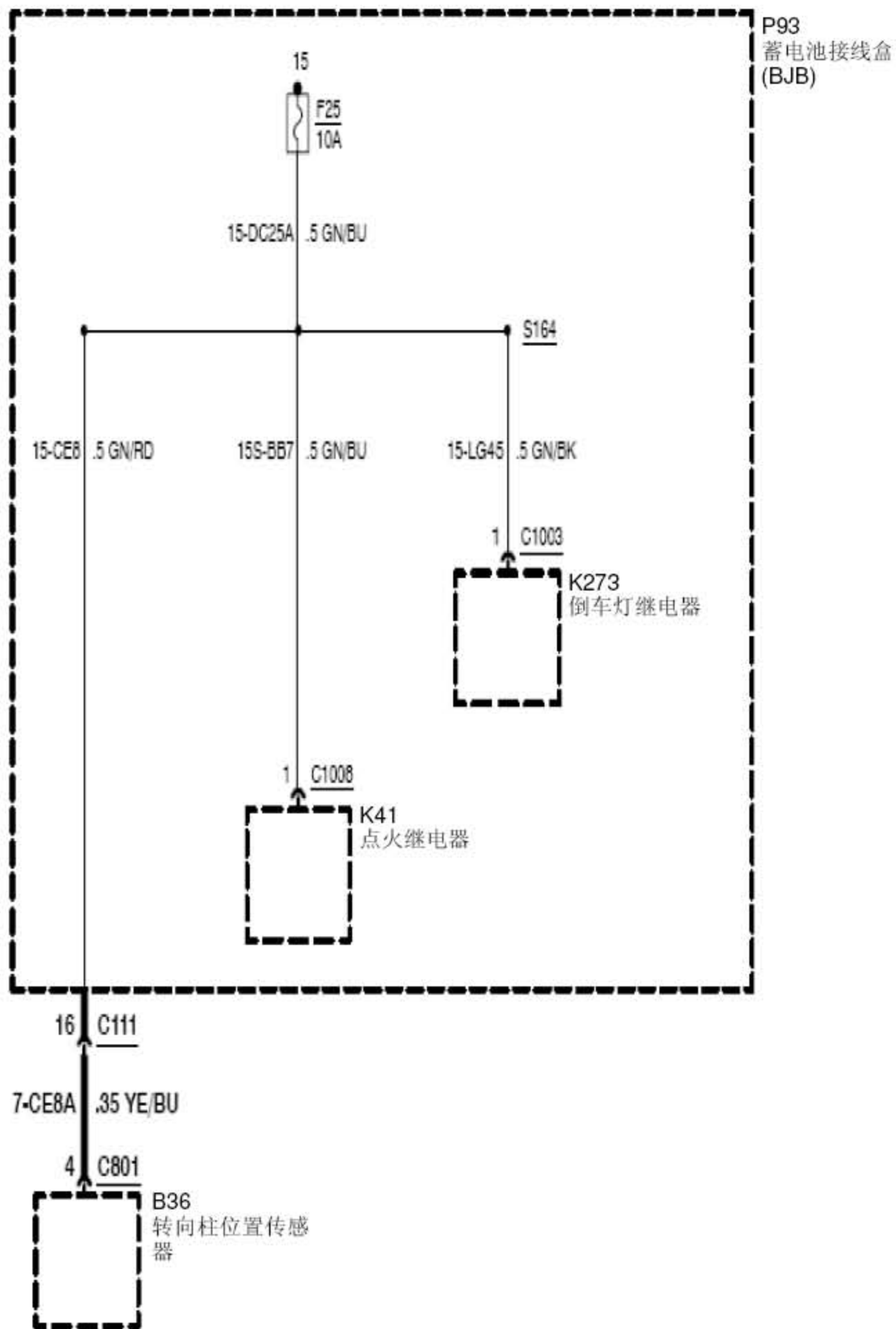

保险丝细节—F25, 2.0L Duratorq—TDCi (DW) 柴油

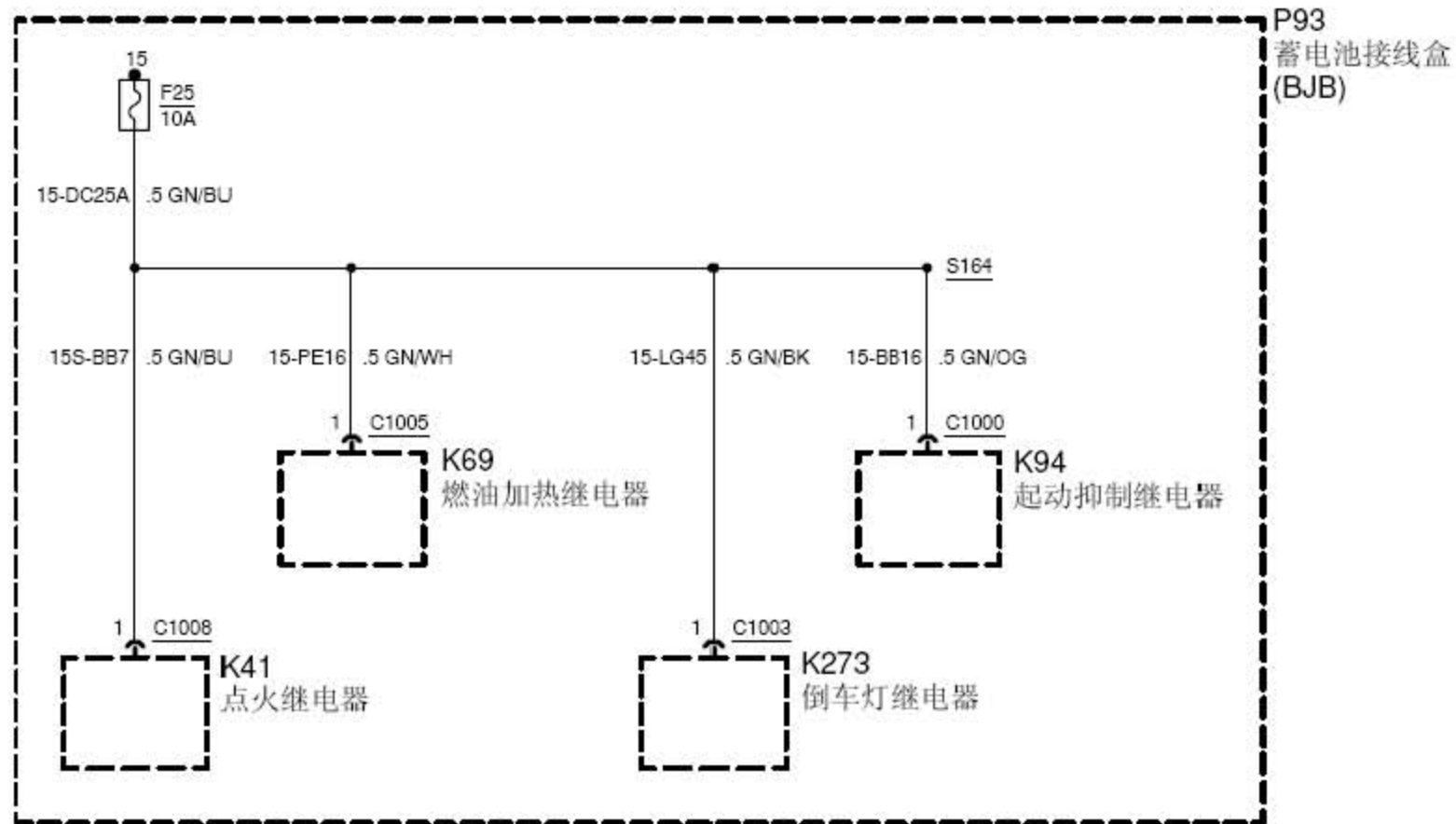

保险丝细节—F25, F26, F28

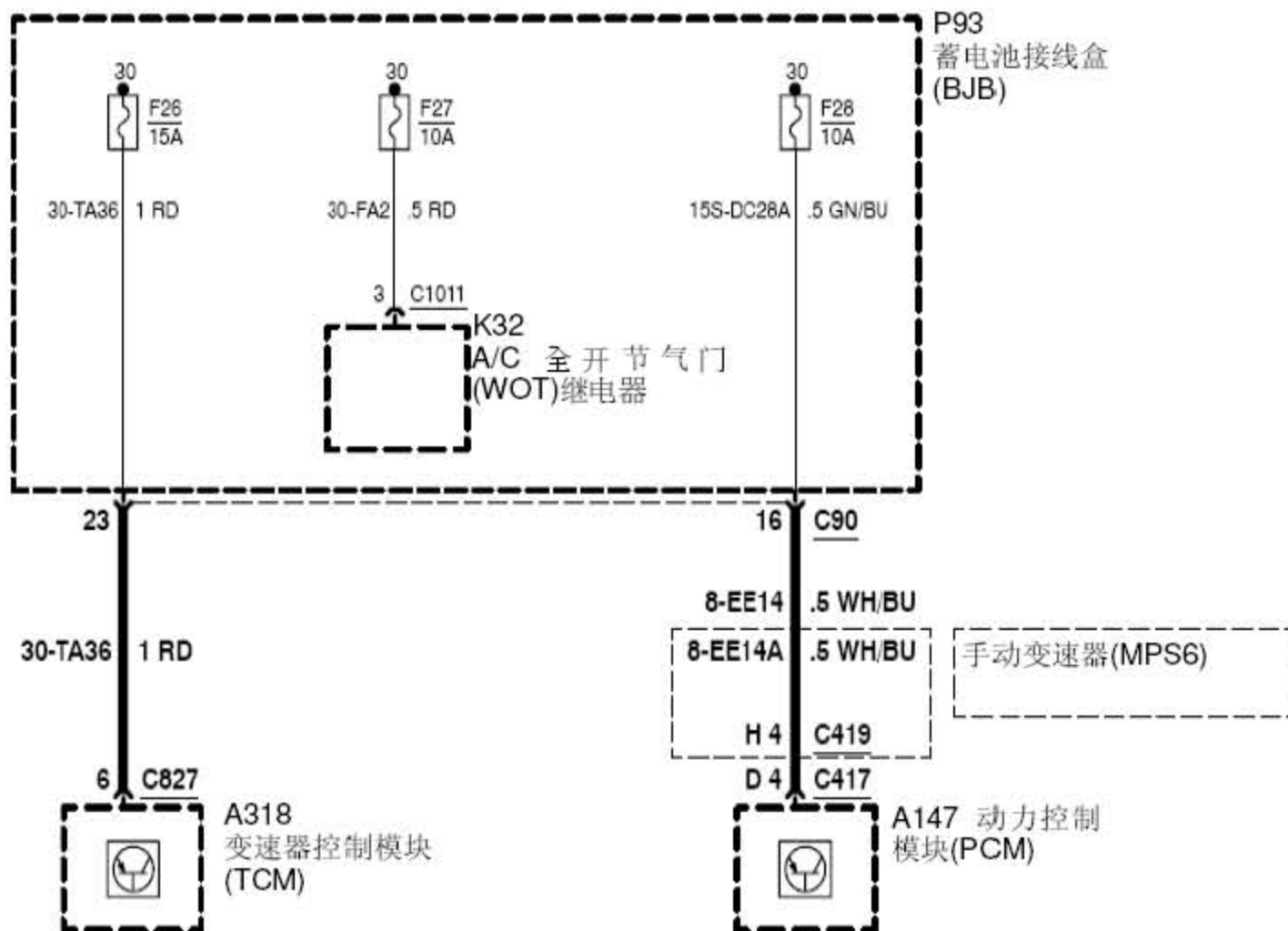

保险丝细节—F30, 1.6L (Z6), 1.8/2.0L Duratec-HE (MI4) 自动变速器

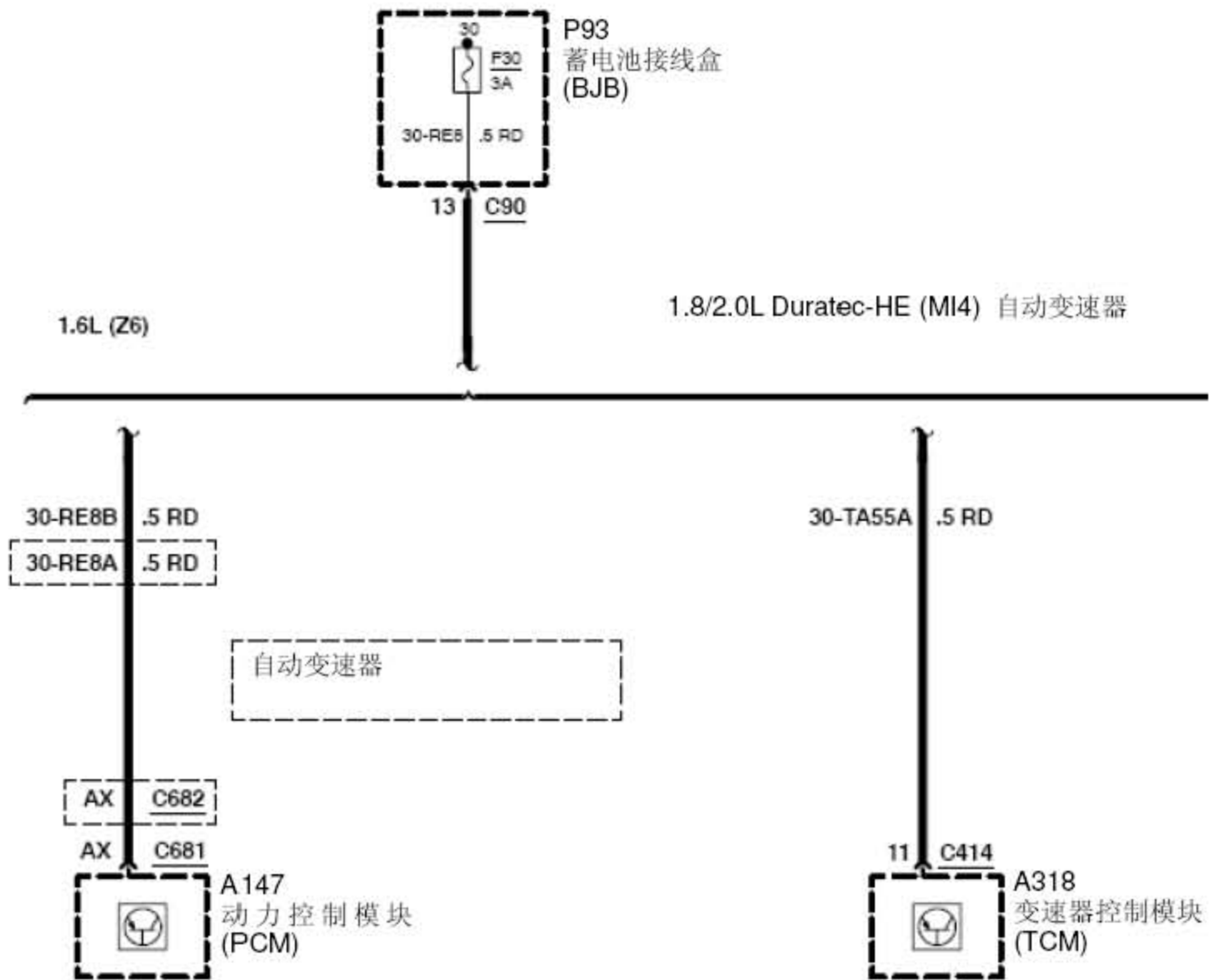

保险丝细节—F30, 2.0L Duratorq.TDCi (DW) 柴油

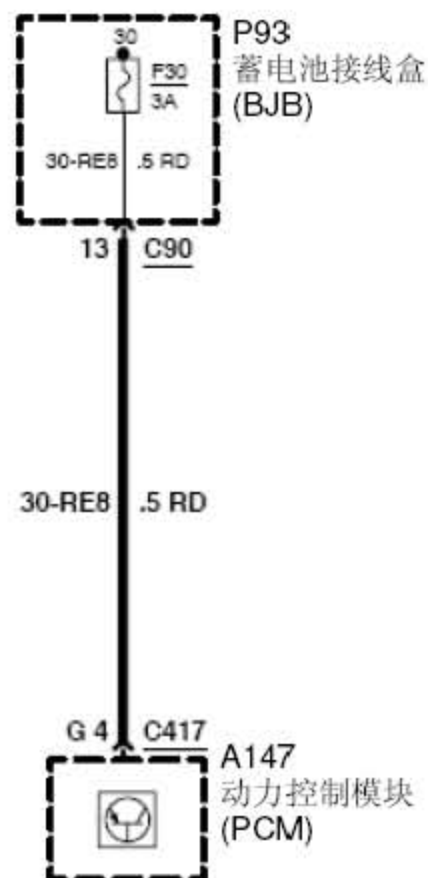

保险丝细节—F31, 不含1.6L (Z6)

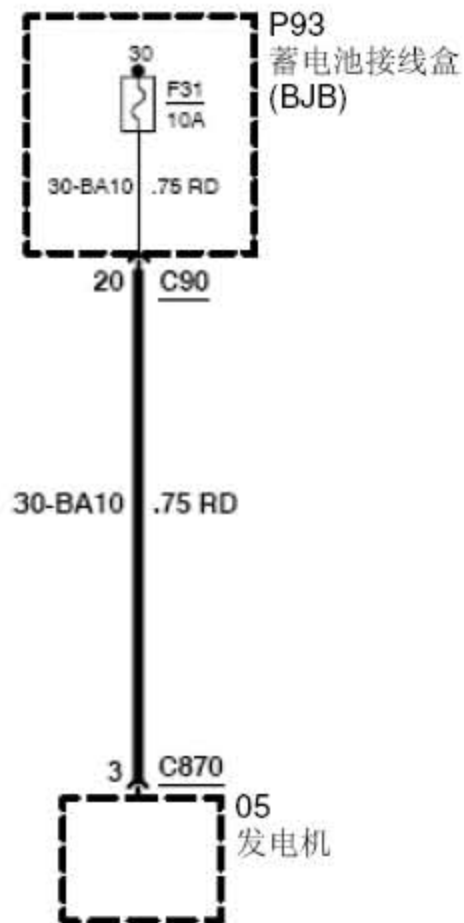

保险丝细节—F32, 自动变速器

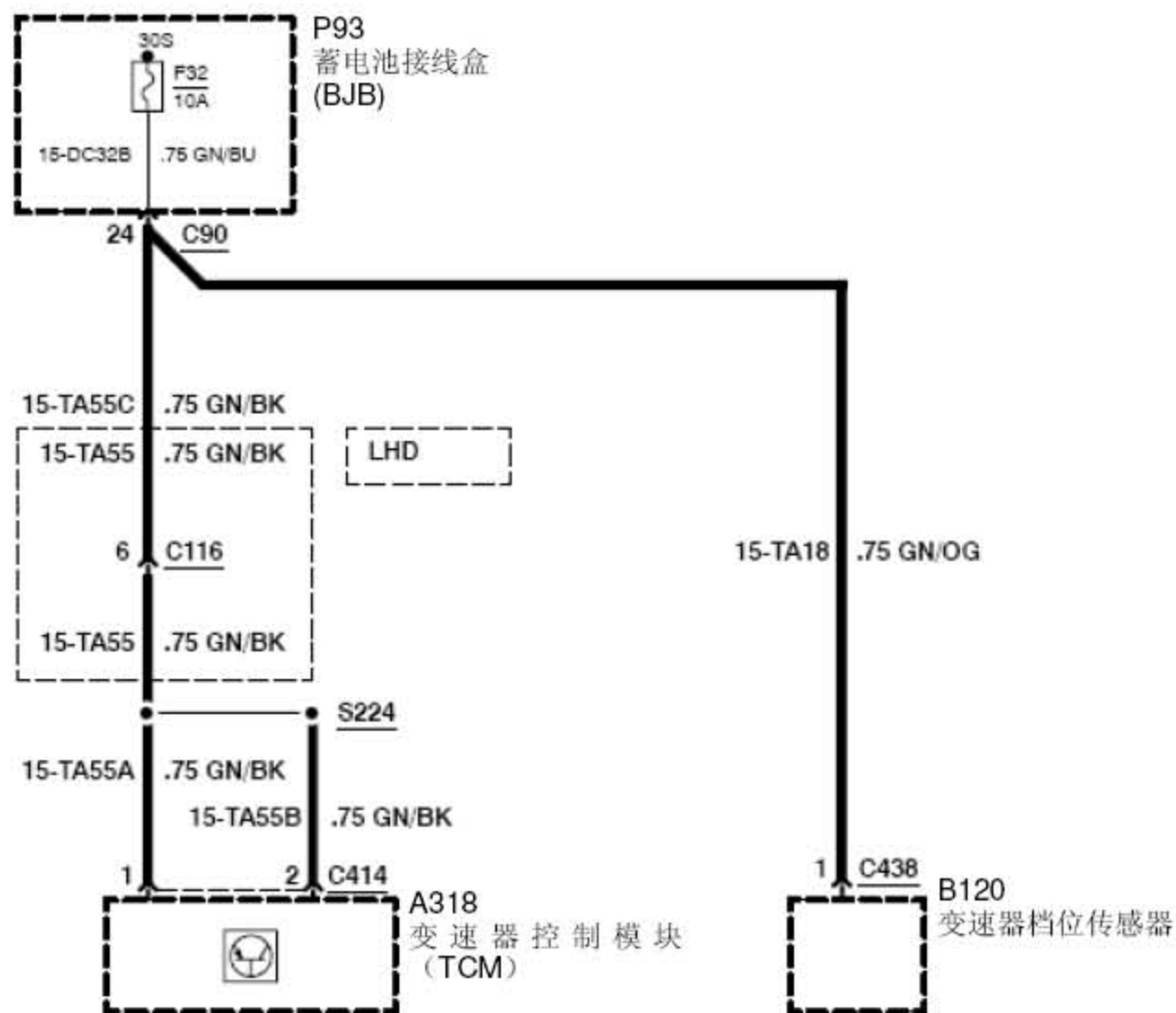

保险丝细节—F32, F33, 1.6L (Z6)

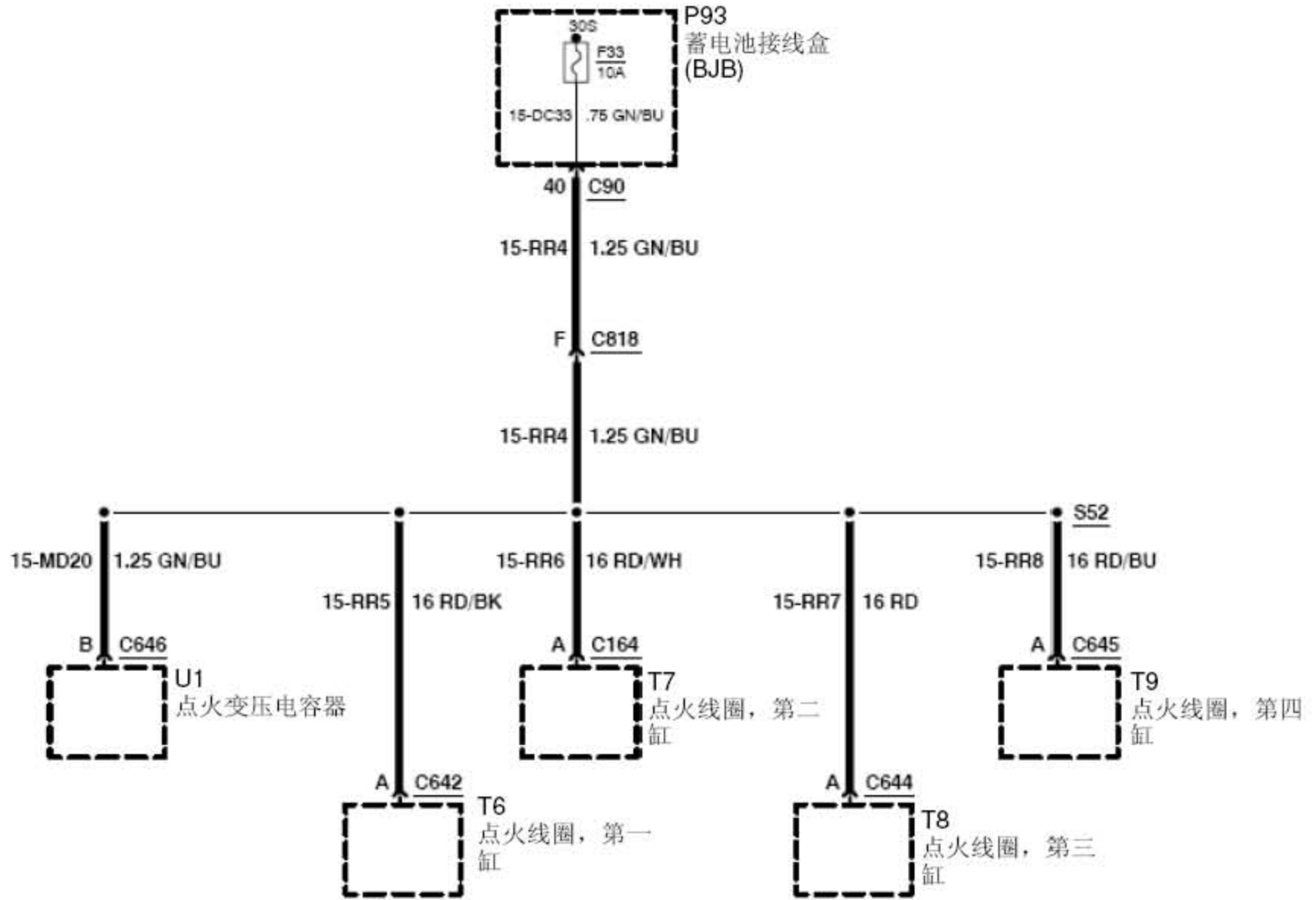

保险丝细节—F33, 1.8/2.0L Duratec-HE (MI4)

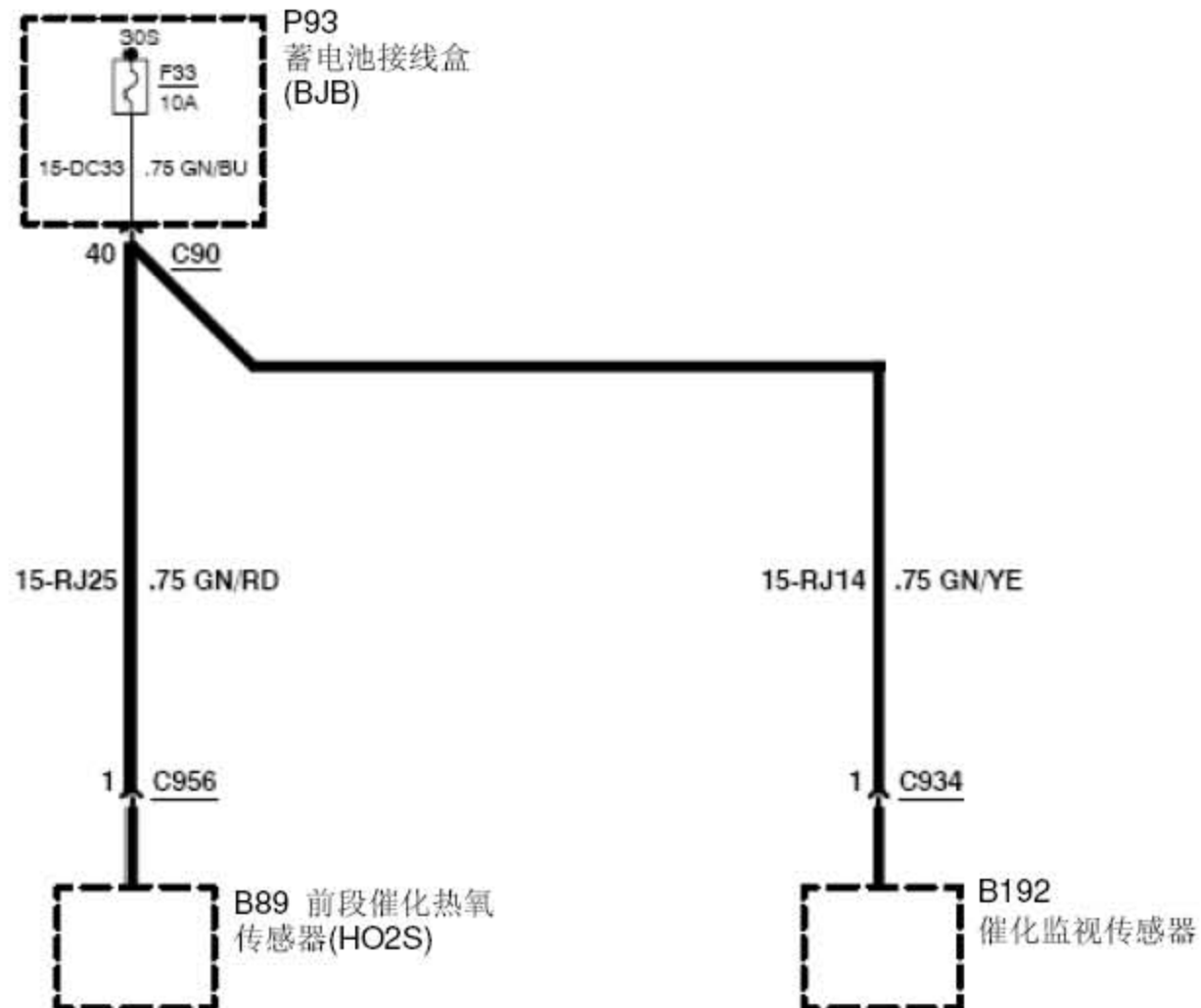

保险丝细节—F33, 2.0L Duratorq-TDCi (DW) 柴油

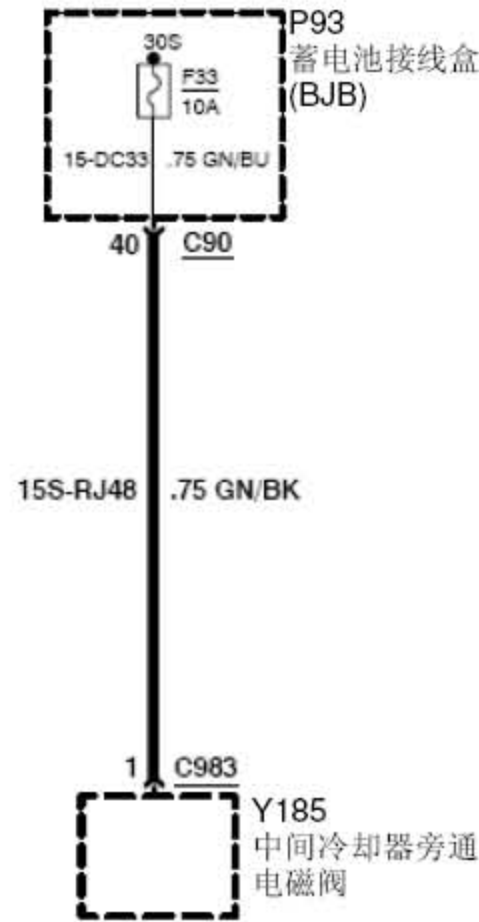

保险丝细节—F34, 1.6L (Z6)

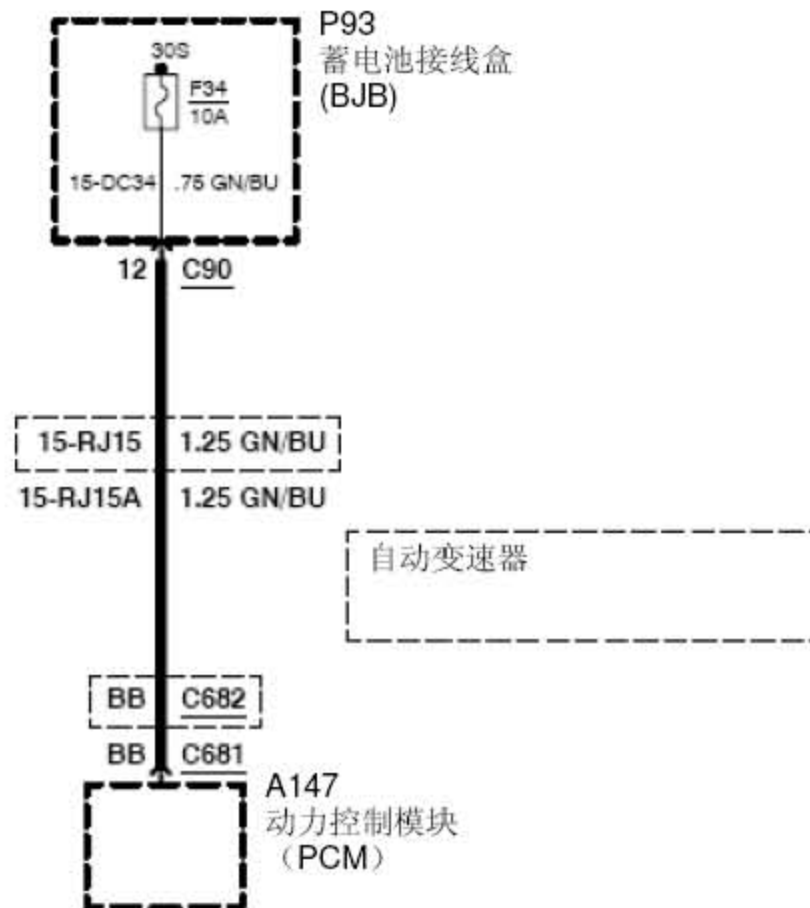

保险丝细节—F34, 1.8/2.0L Duratec-HE (MI4)

70

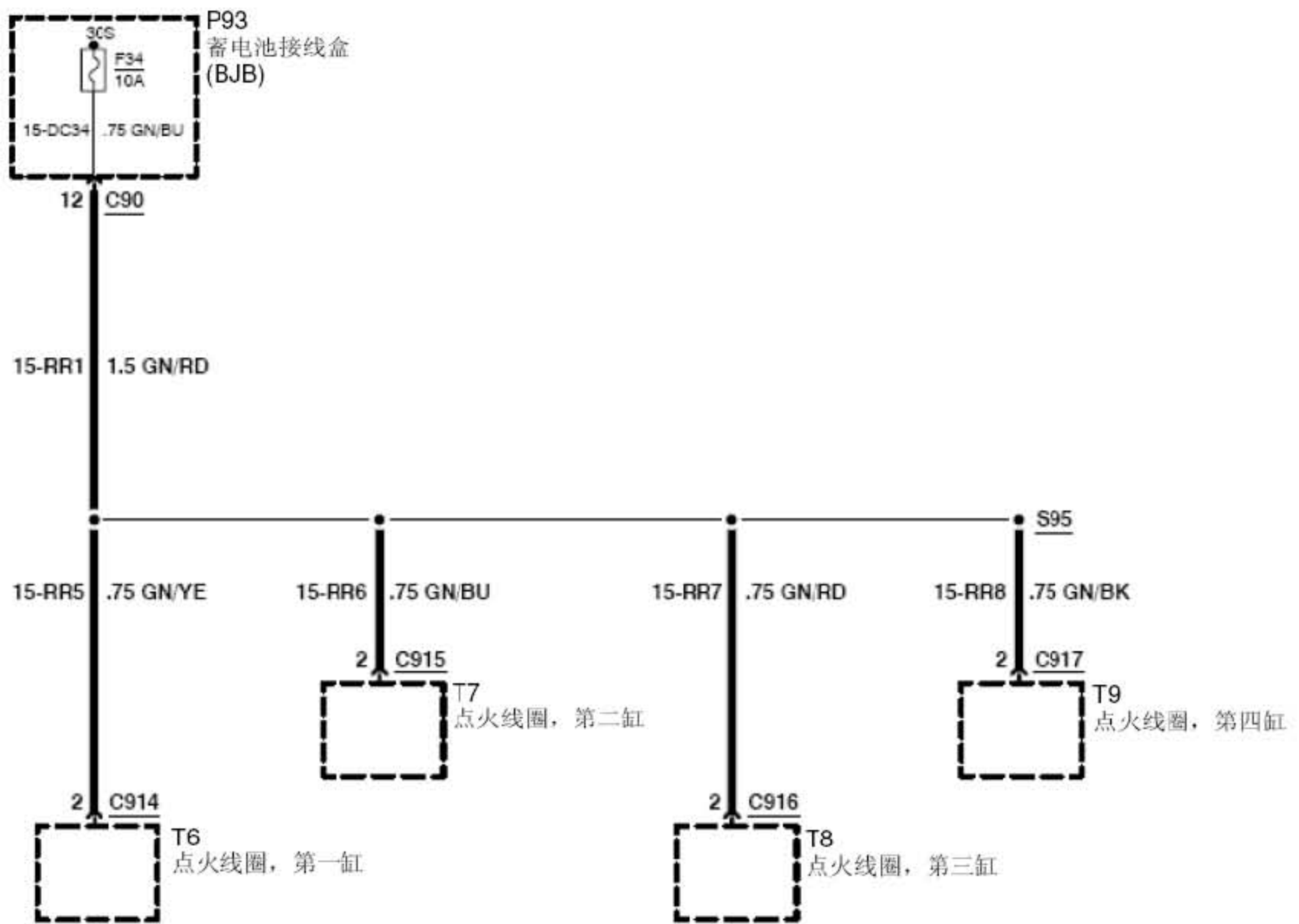

保险丝细节—F34, 2.0L Duratorq-TDCi (DW) 柴油

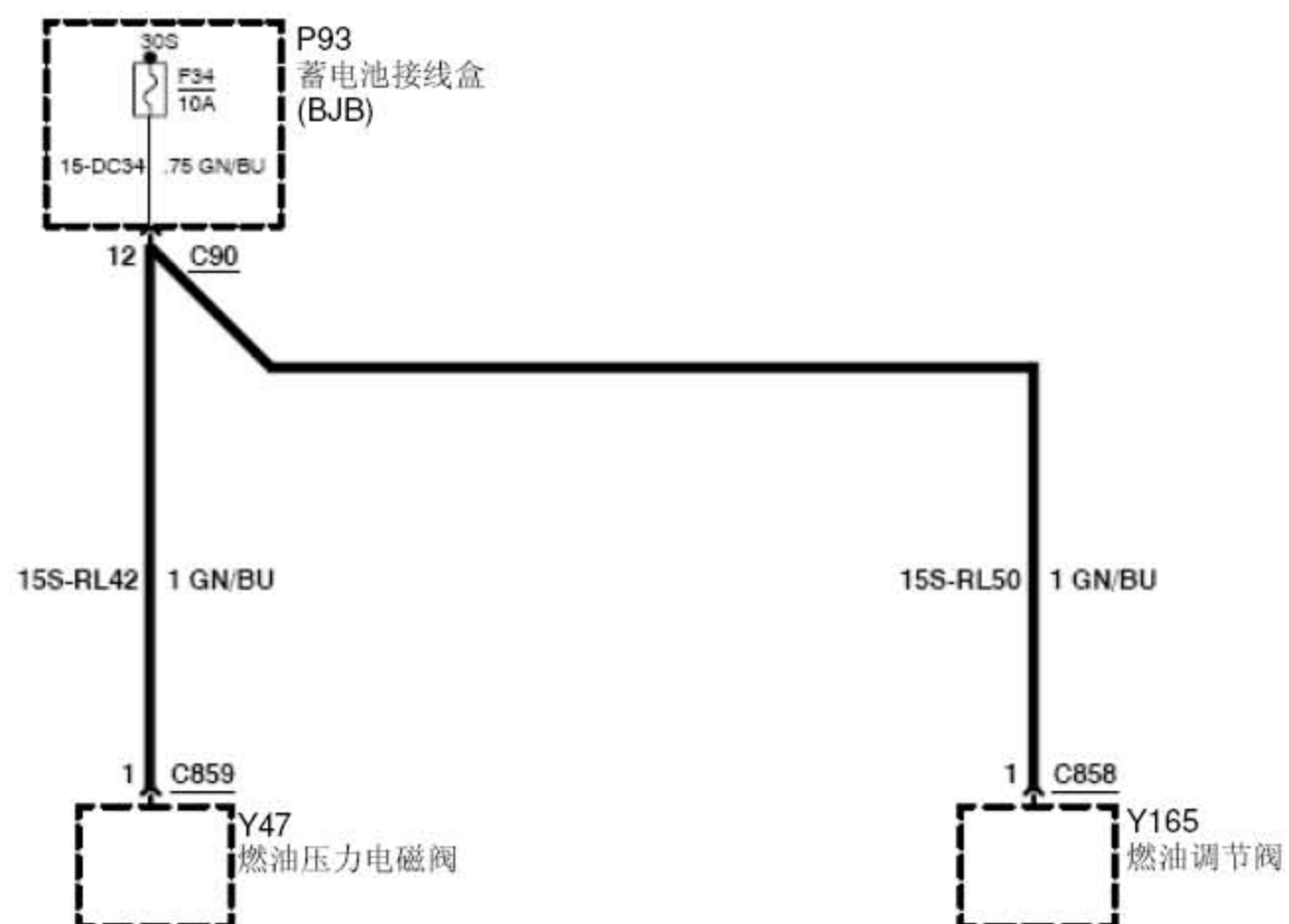

保险丝细节—F35, 1.6L (Z6)

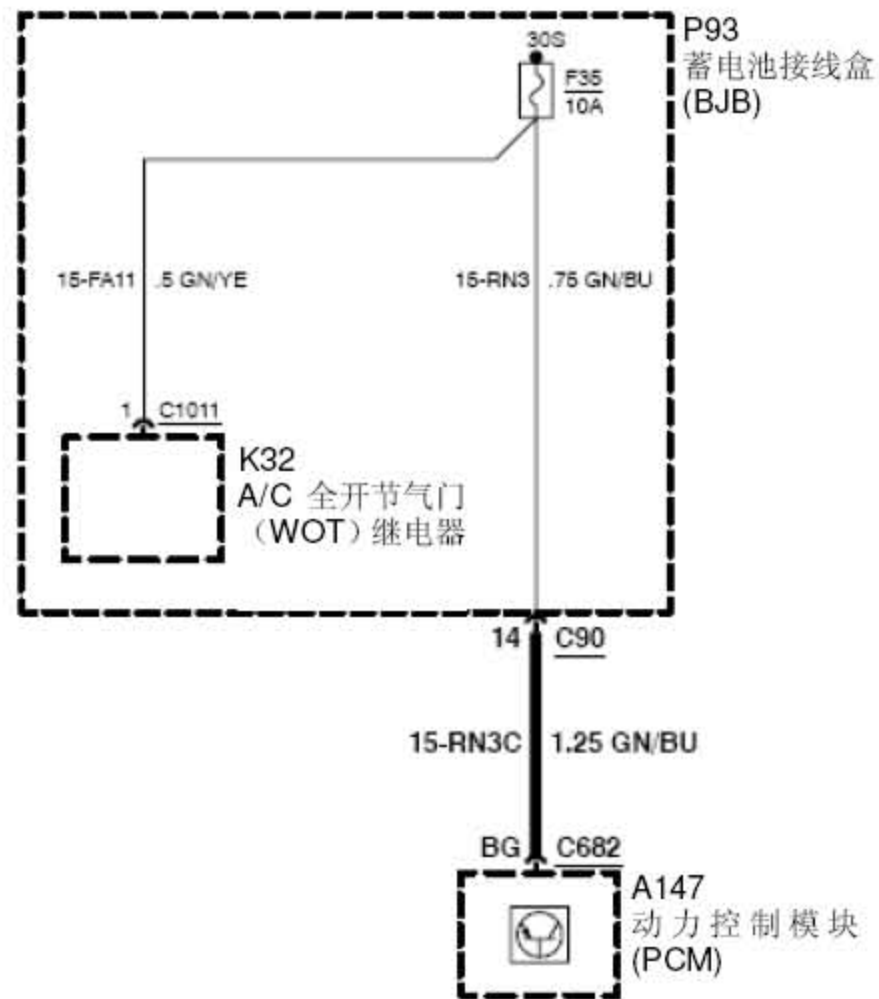

LAUNCH

保险丝细节—F35, 1.8/2.0L Duratec-HE (MI4)

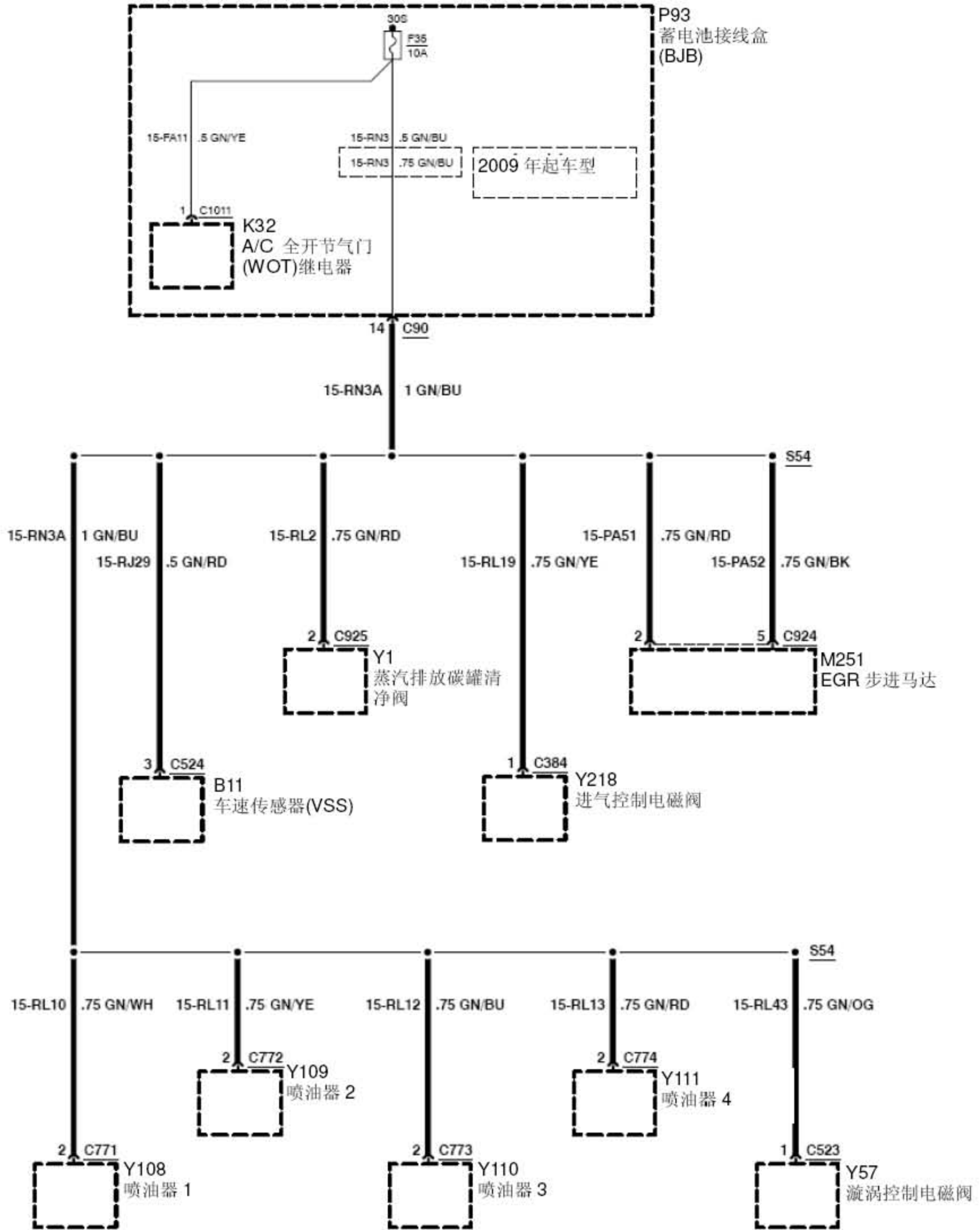

保险丝细节—F35, 2.0L Duratorq.TDCi (DW) 柴油

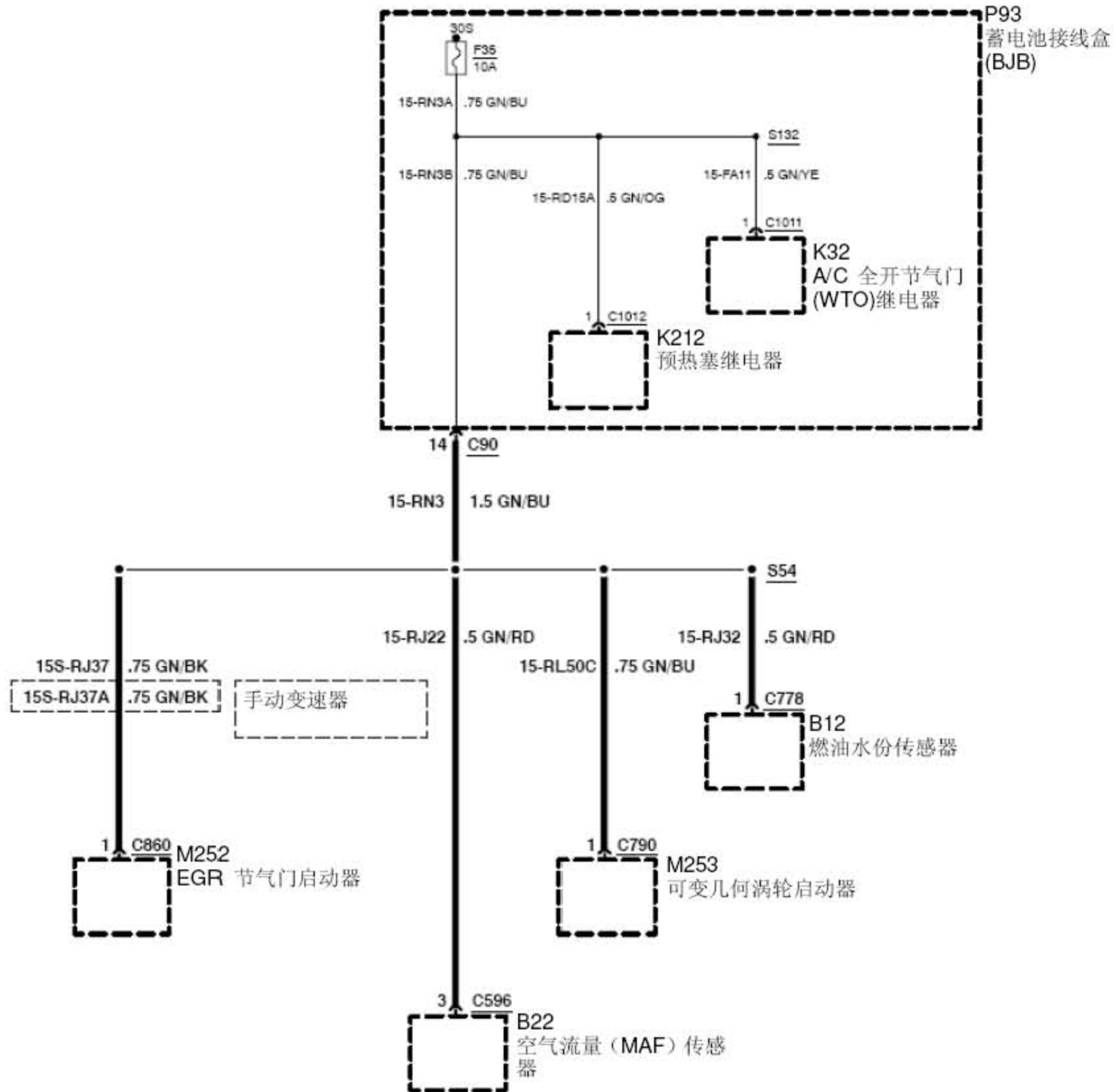

保险丝细节—F36, 1.6L (Z6)

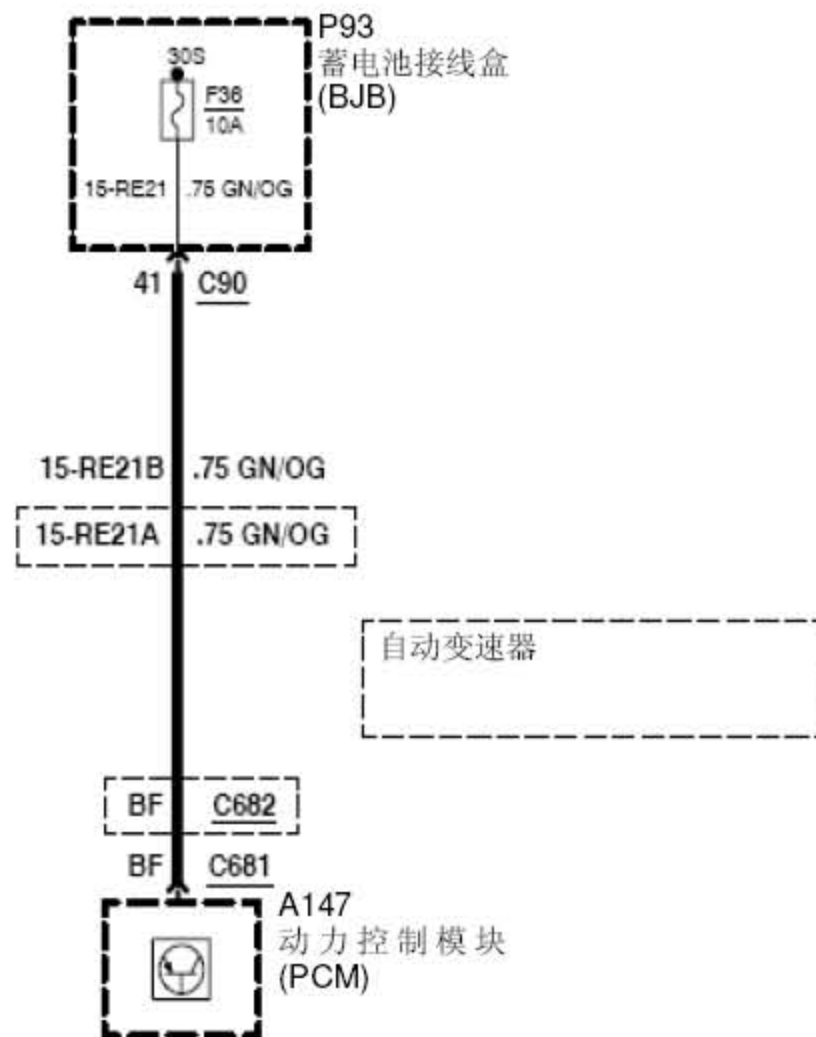

保险丝细节—F36, 1.8/2.0L Duratec-HE (MI4)

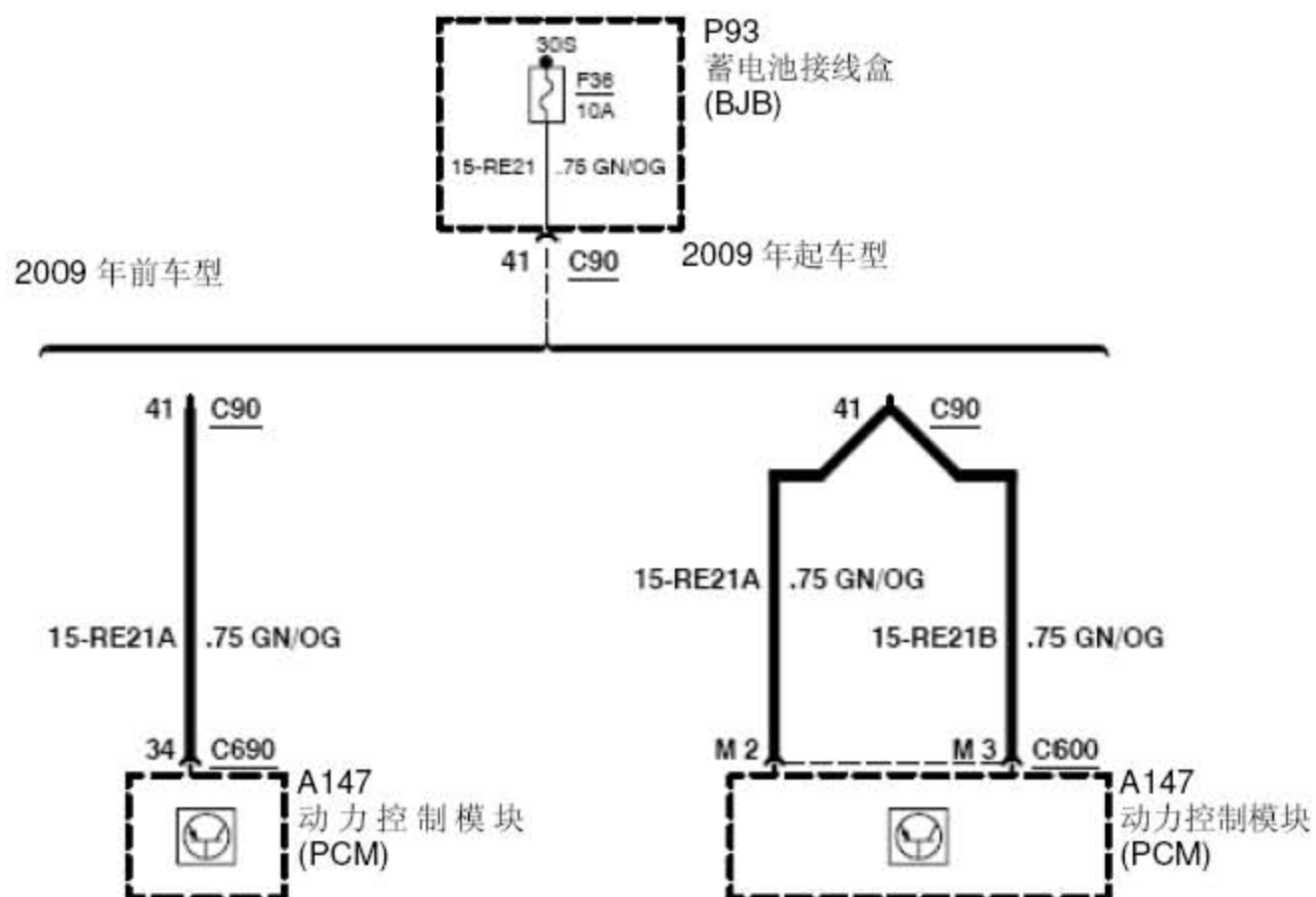

保险丝细节—F36, 2.0L Duratorq-TDCi (DW) Diesel

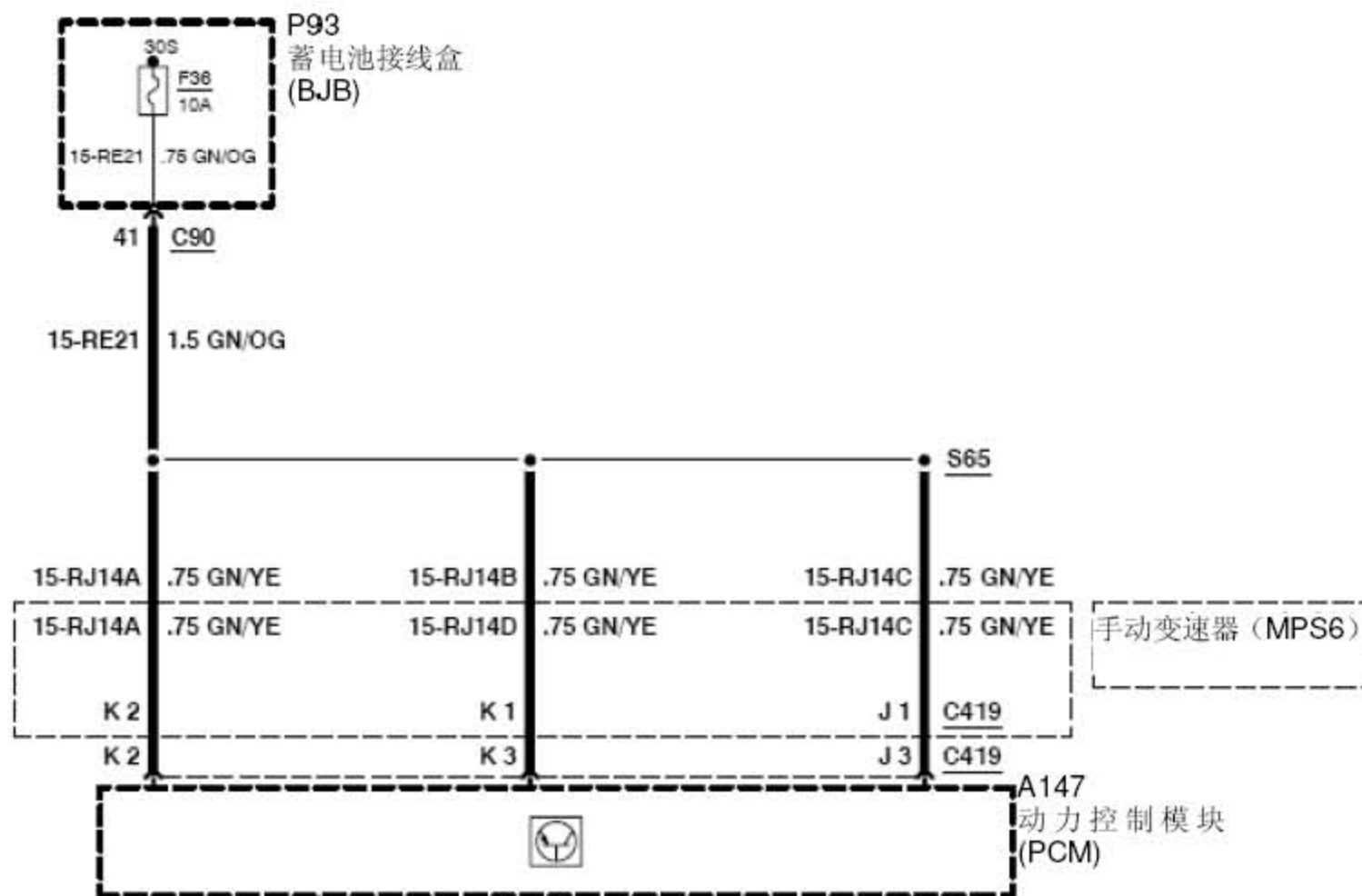

LAUNCH

保险丝细节—F100

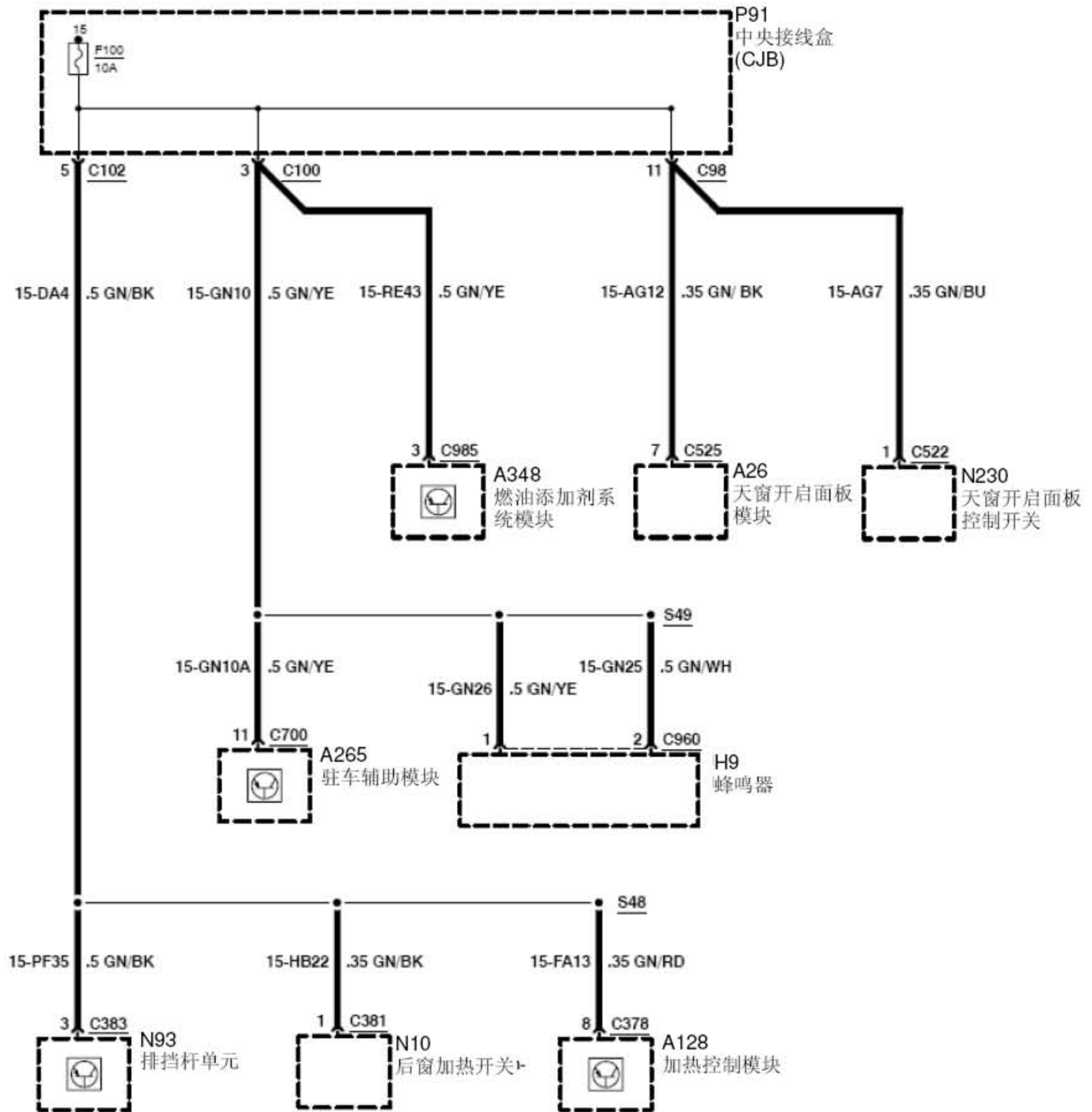

保险丝细节—F101

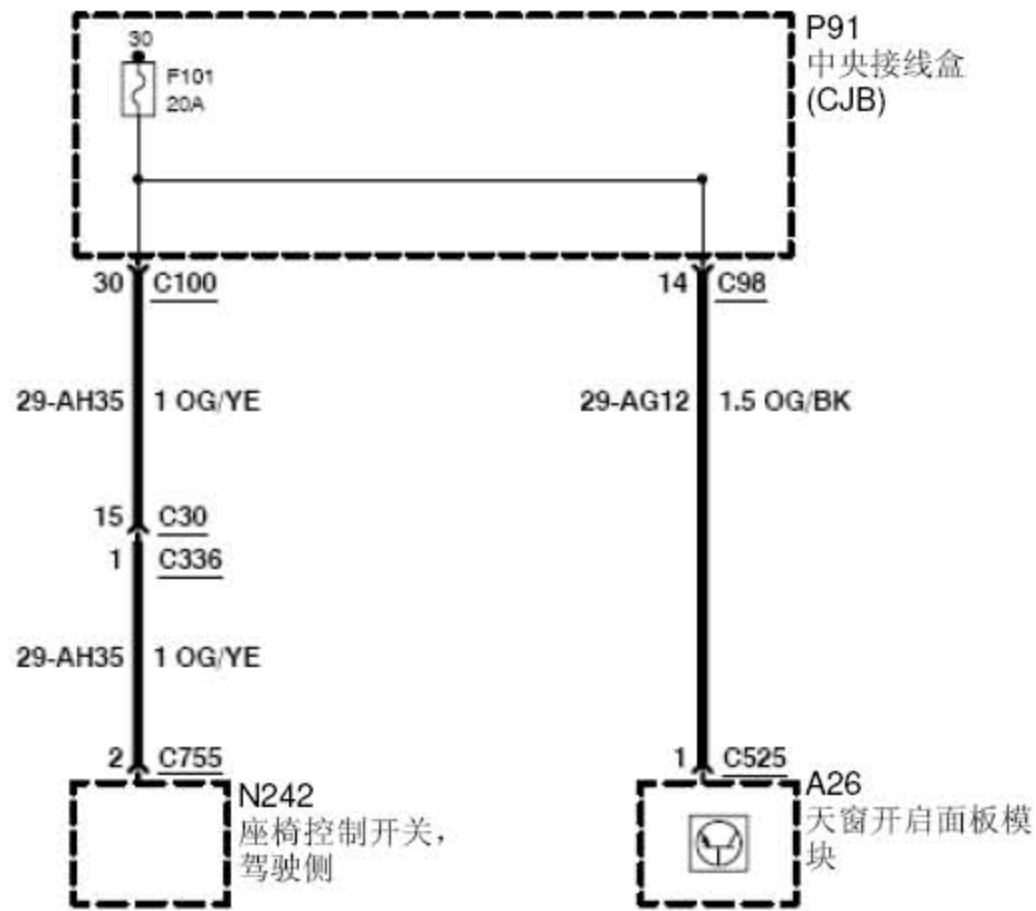

LAUNCH

保险丝细节—F102, F103, F104

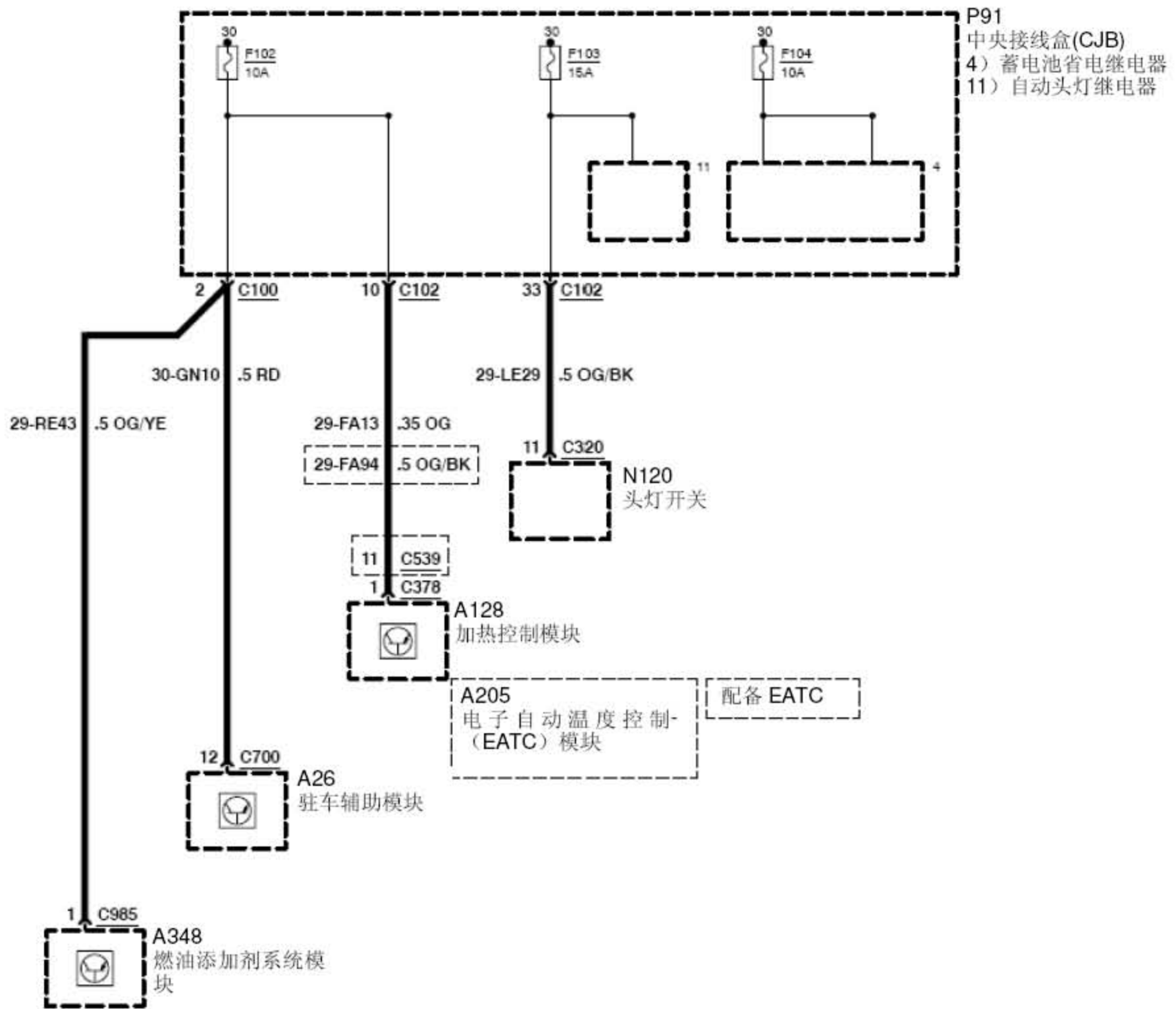

保险丝细节—F105, F106, 107

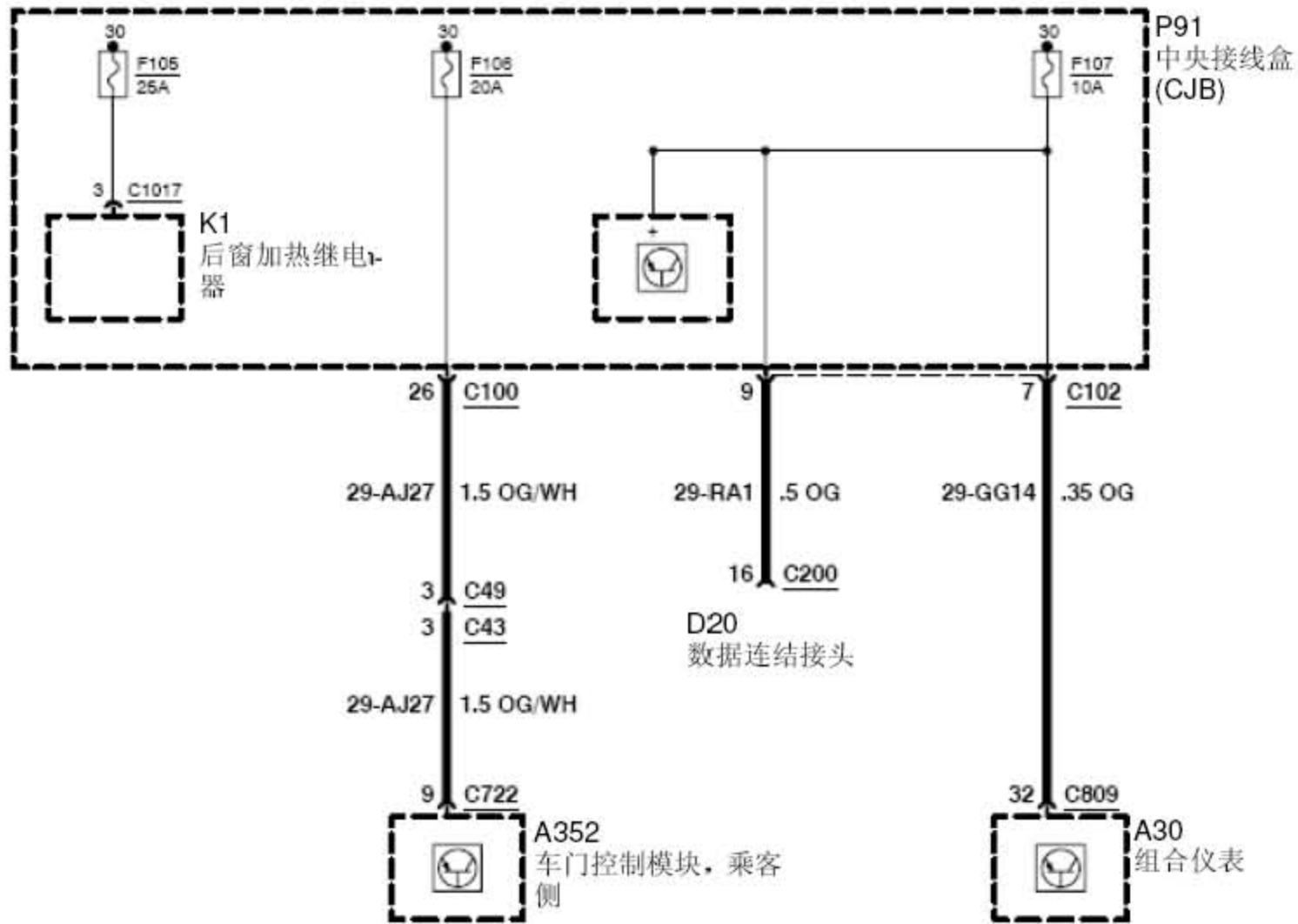

LAUNCH

保险丝细节 - F108

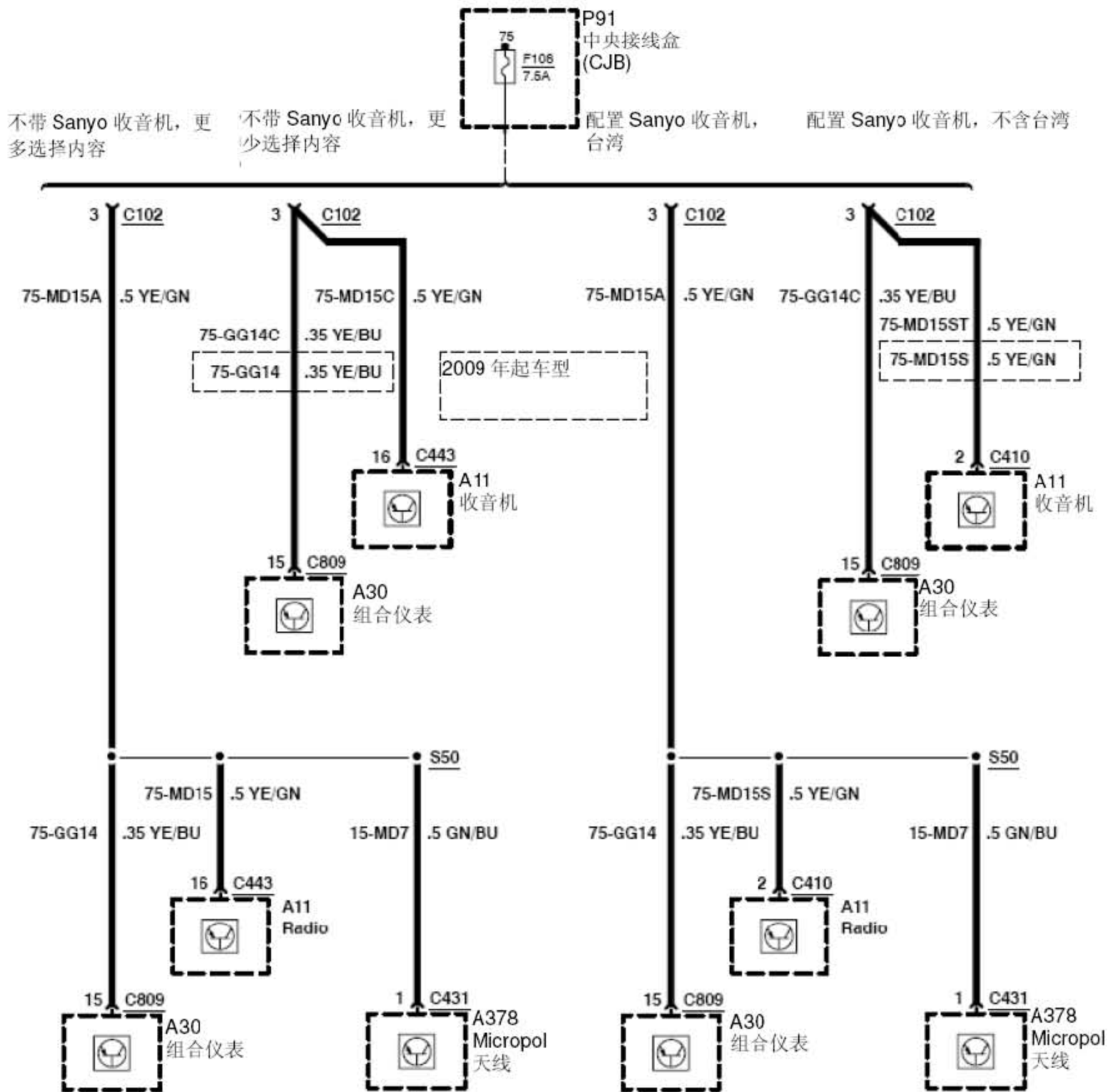

不带 Sanyo 收音机, 更多选择内容

不带 Sanyo 收音机, 更少选择内容

配置 Sanyo 收音机, 台湾

配置 Sanyo 收音机, 不含台湾

2009 年起车型

保险丝细节—F109



保险丝细节—F111

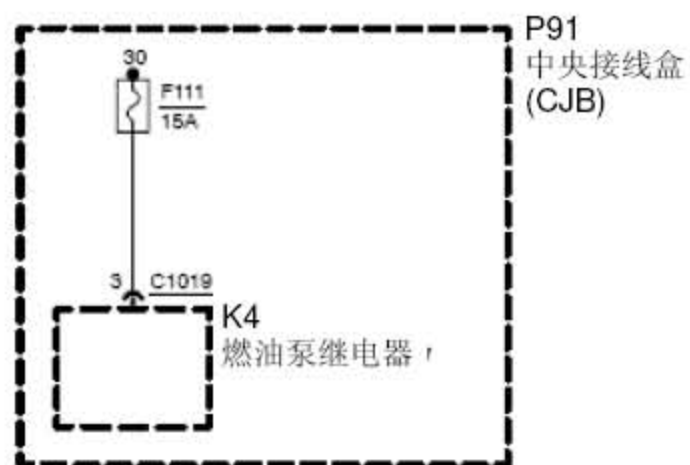

保险丝细节—F112

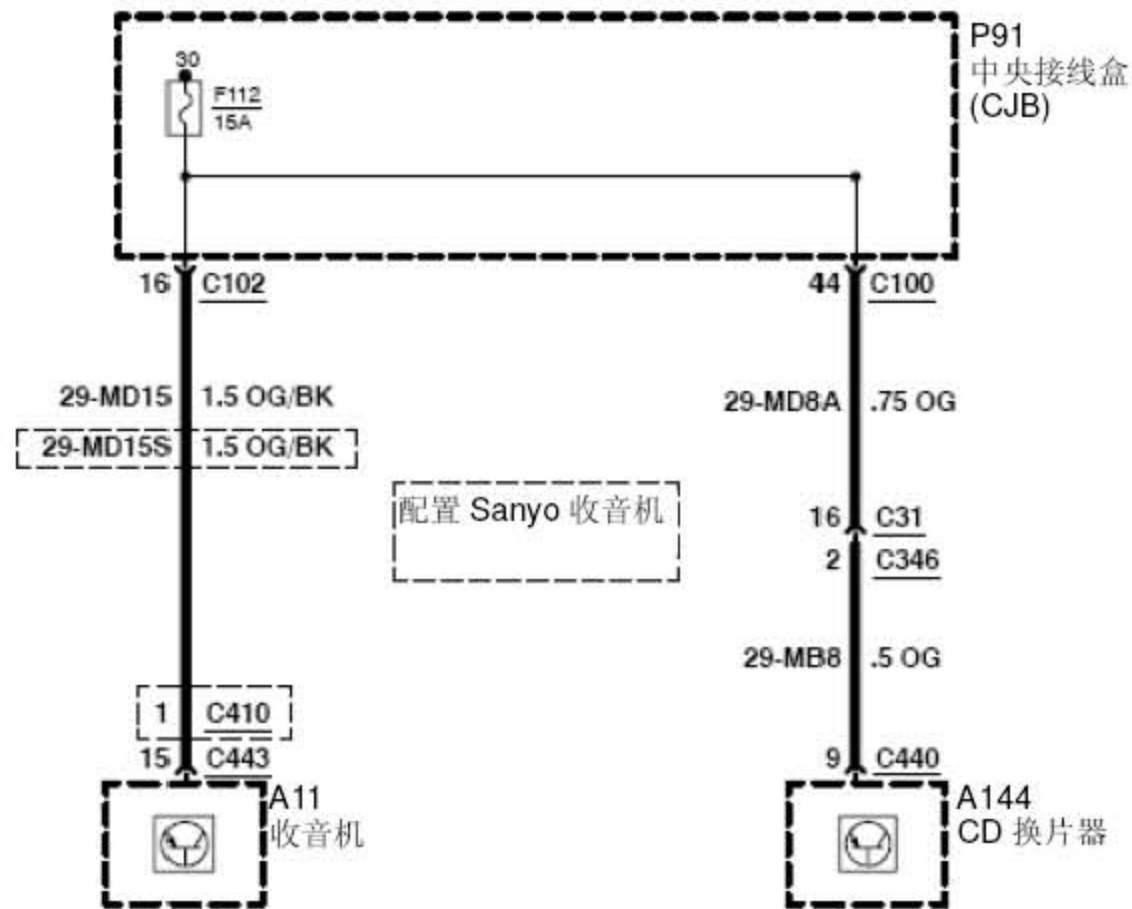

保险丝细节—F114, F115

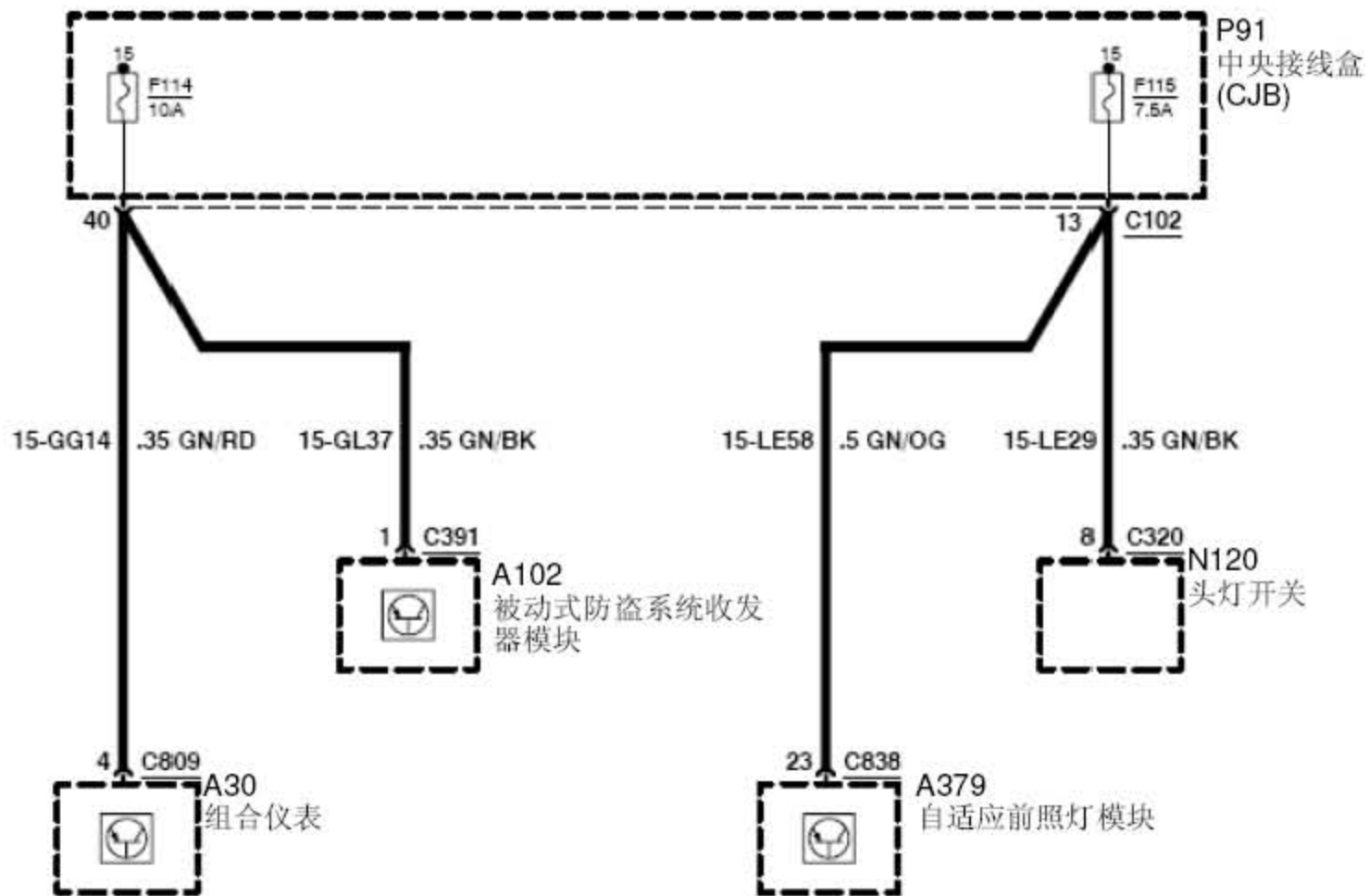

保险丝细节—F116

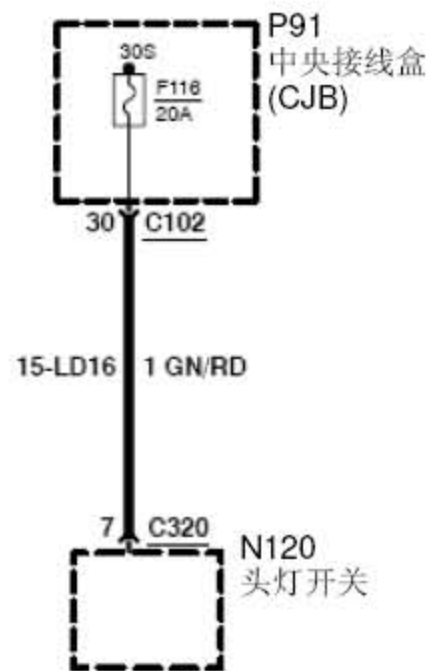

保险丝细节—F117

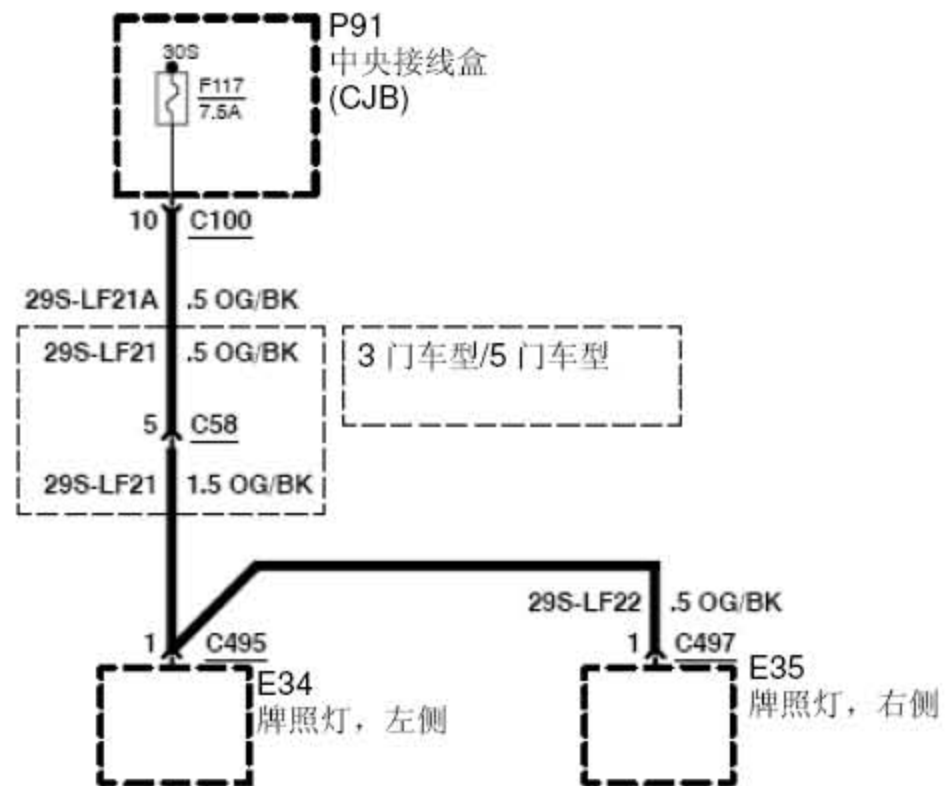

保险丝细节—F118, F120



保险丝细节—F122

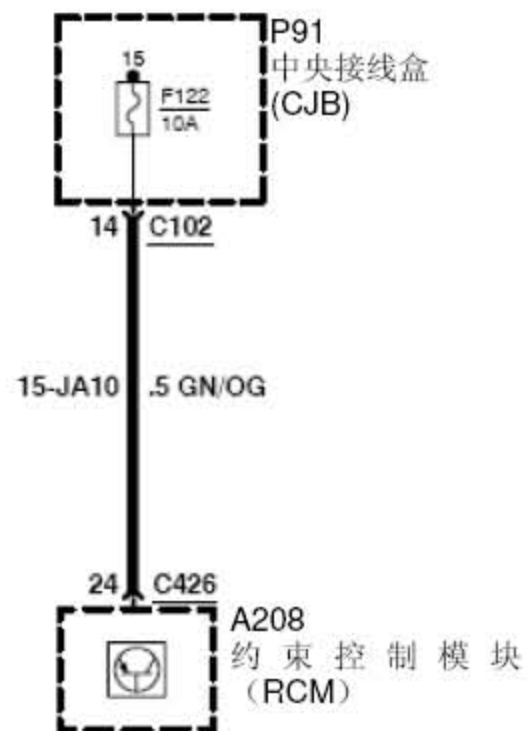

保险丝细节—F124

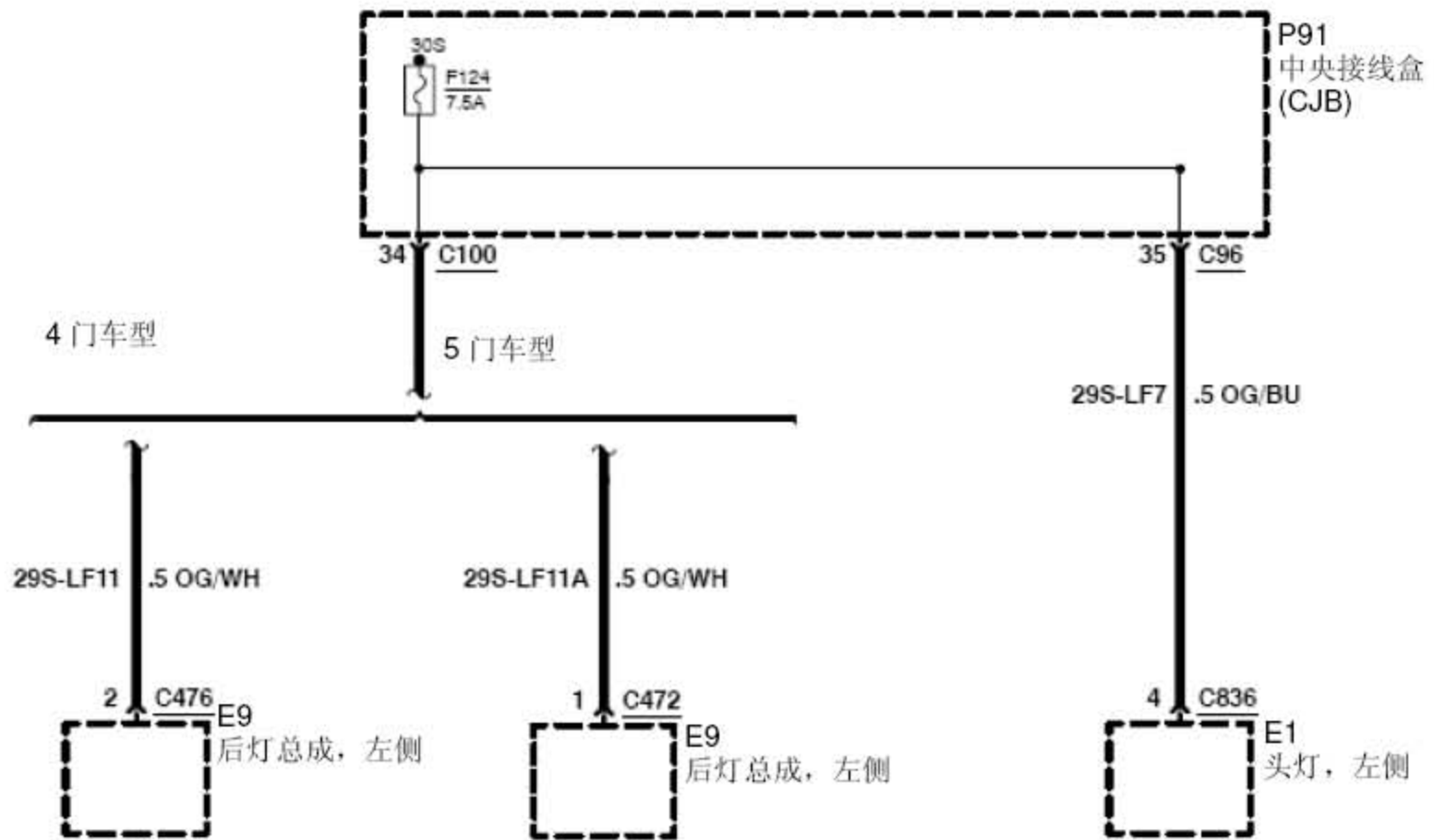

保险丝细节—F125

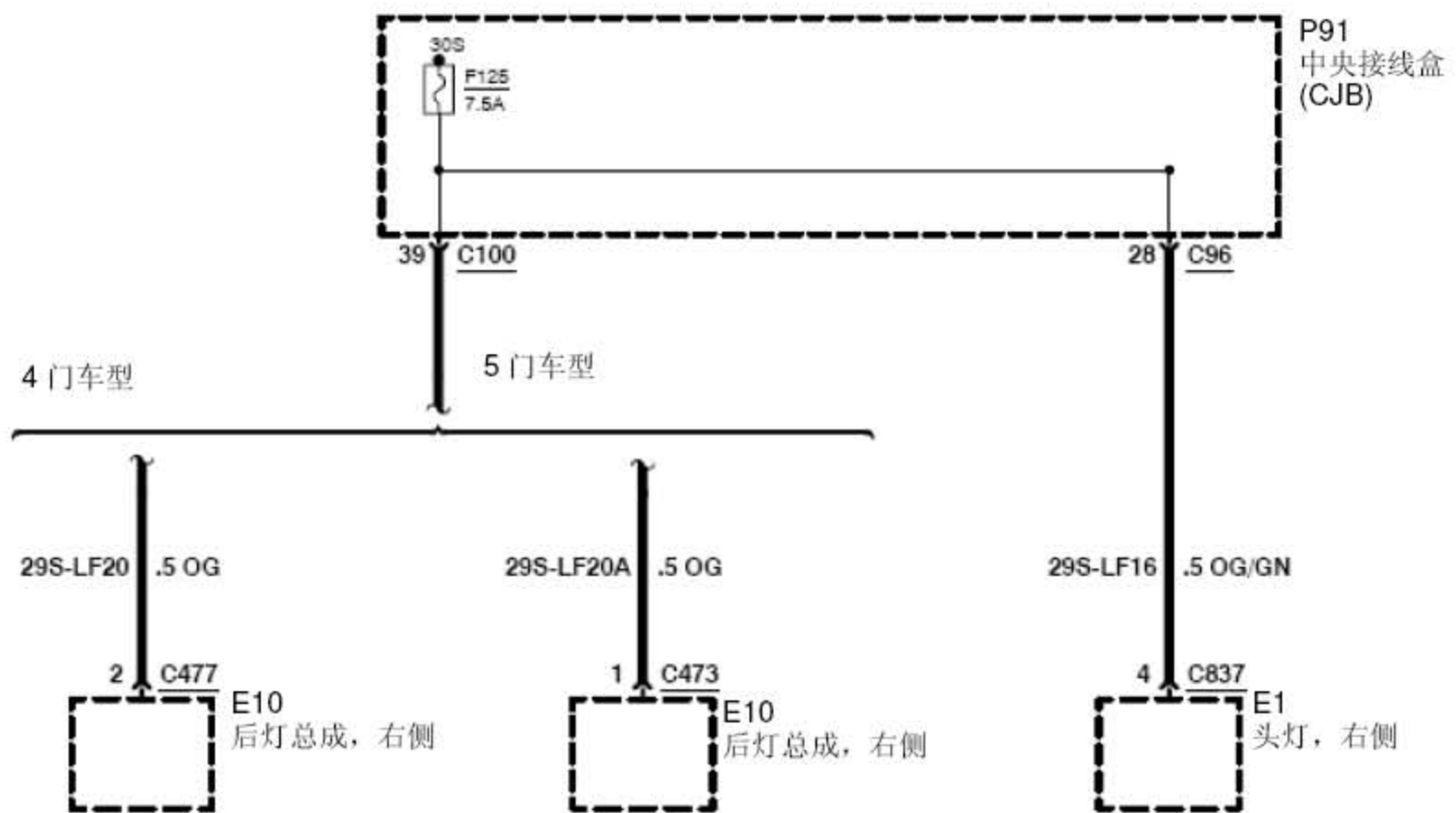

保险丝细节—F127

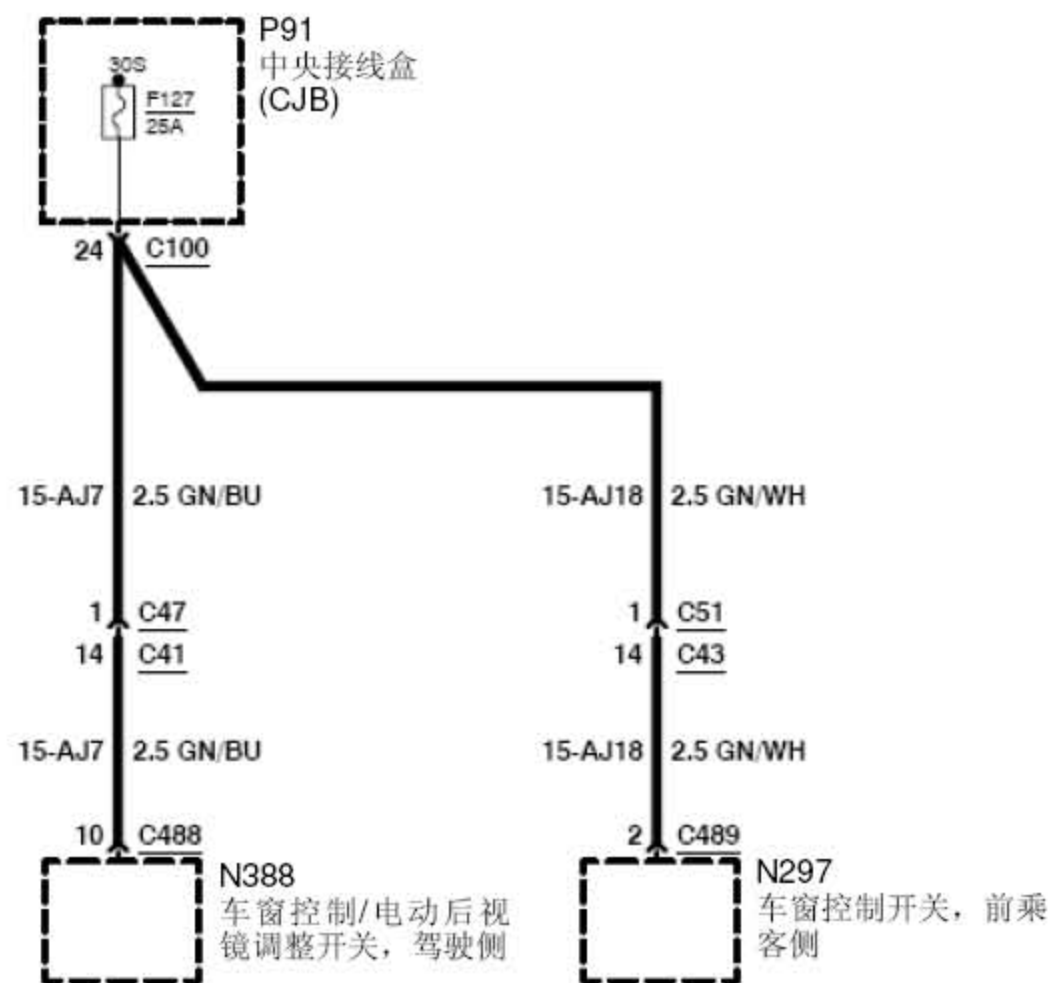

保险丝细节—F129

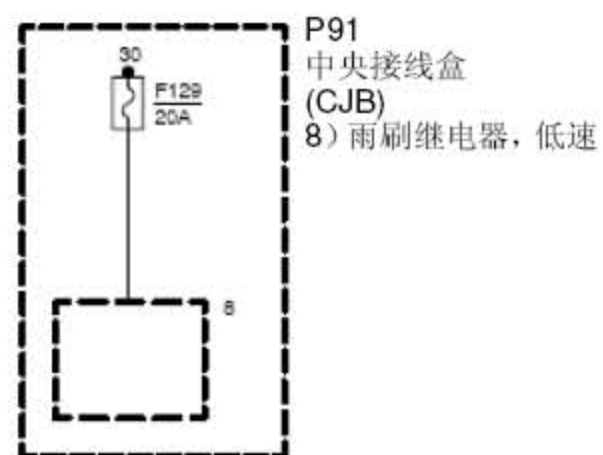

保险丝细节—F131

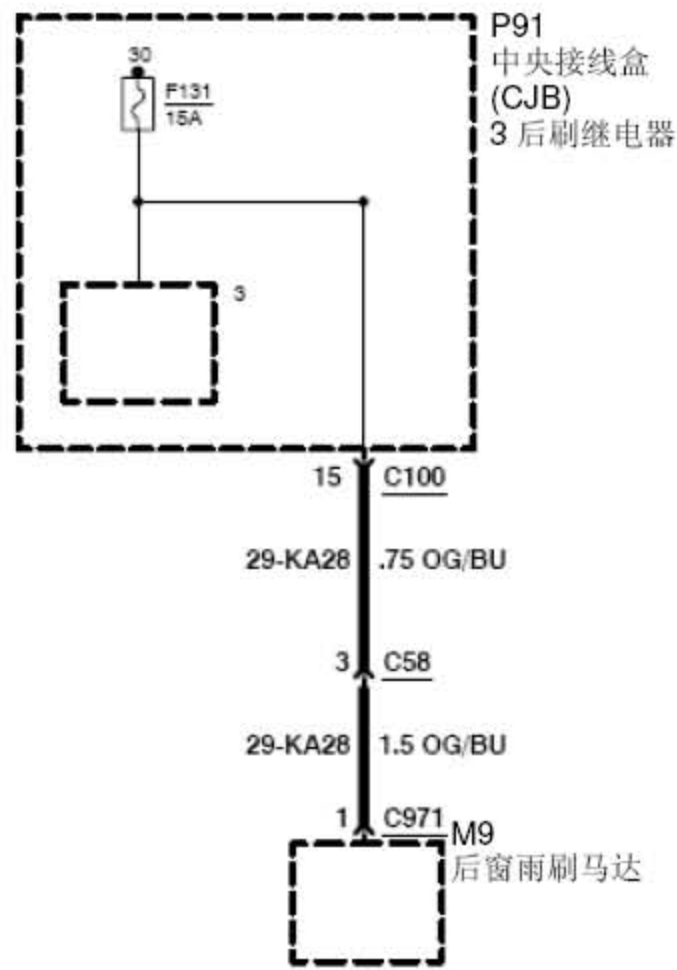

保险丝细节—F132

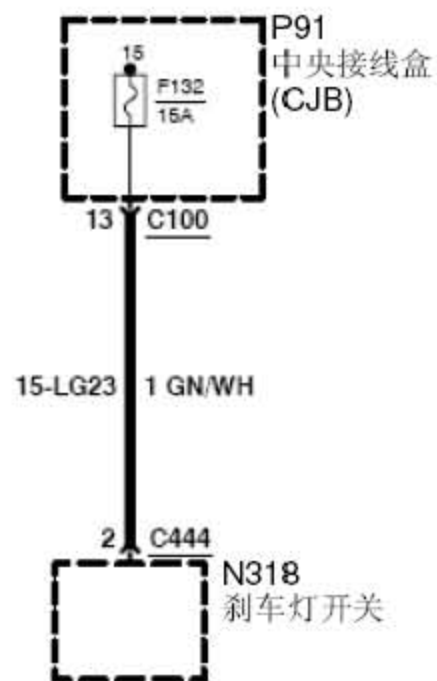

保险丝细节—F133, F134

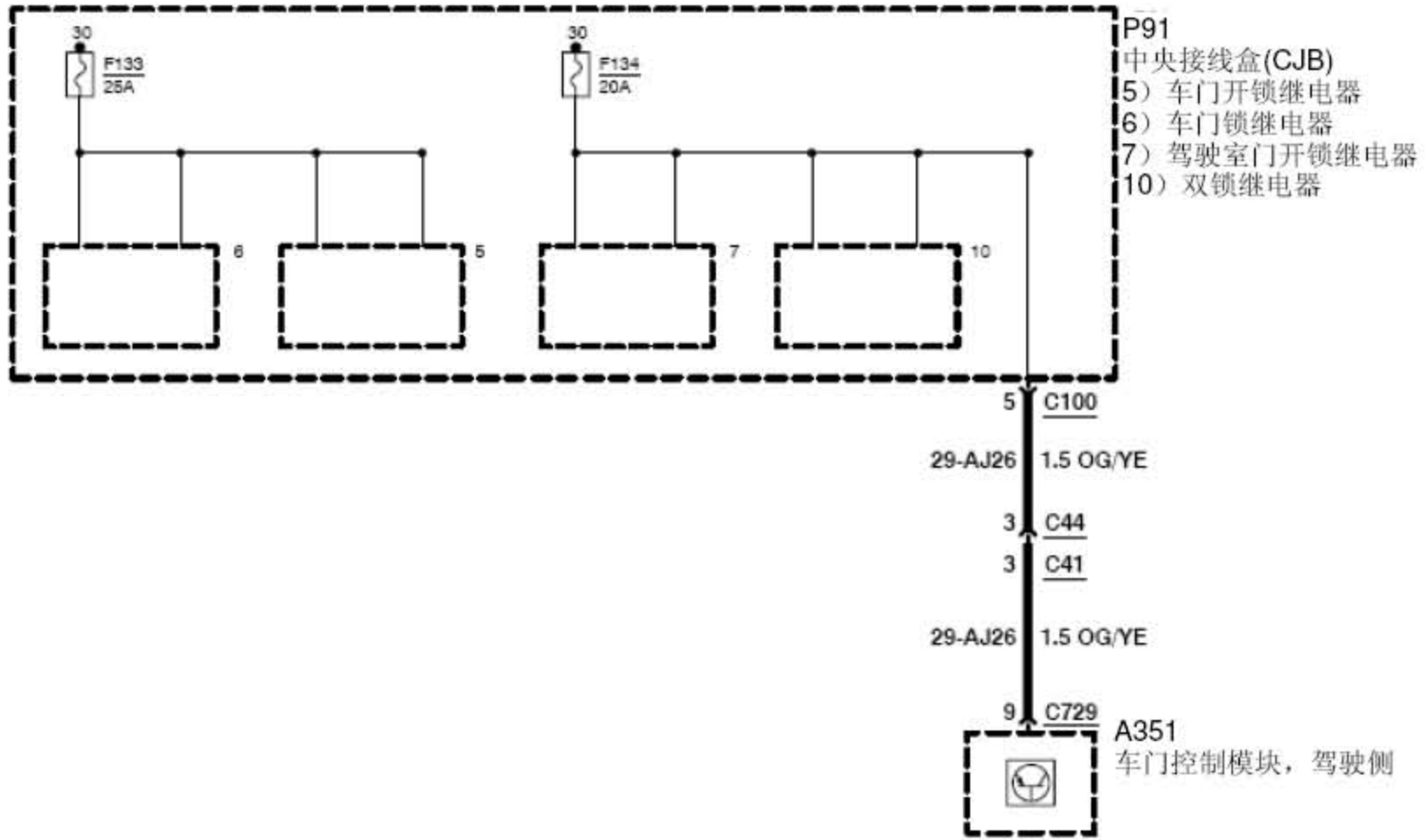

保险丝细节—F135, 136

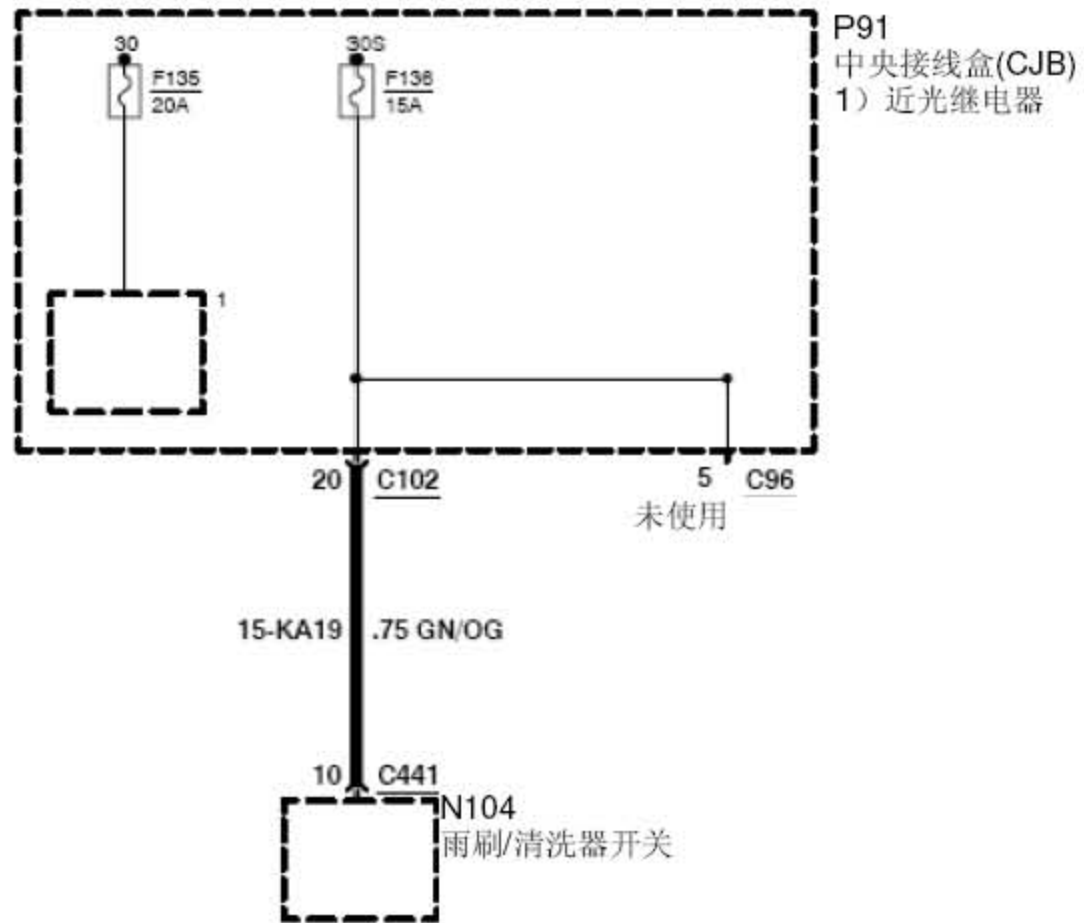

保险丝细节—F137

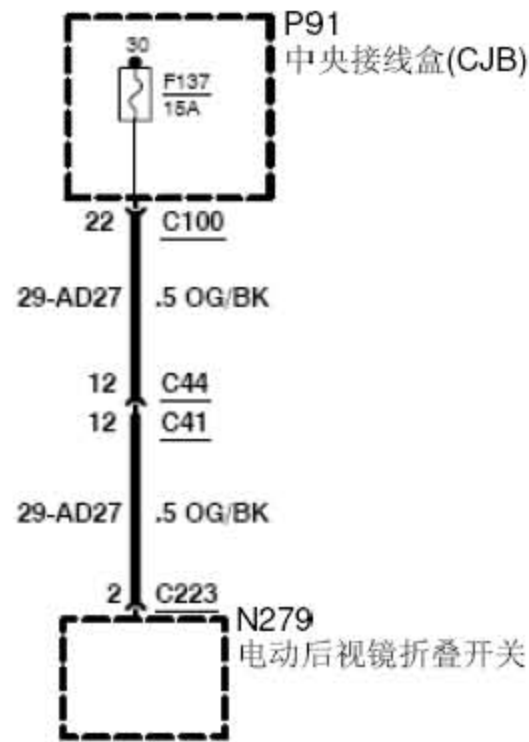

保险丝细节—F138, 1.6L (Z6)

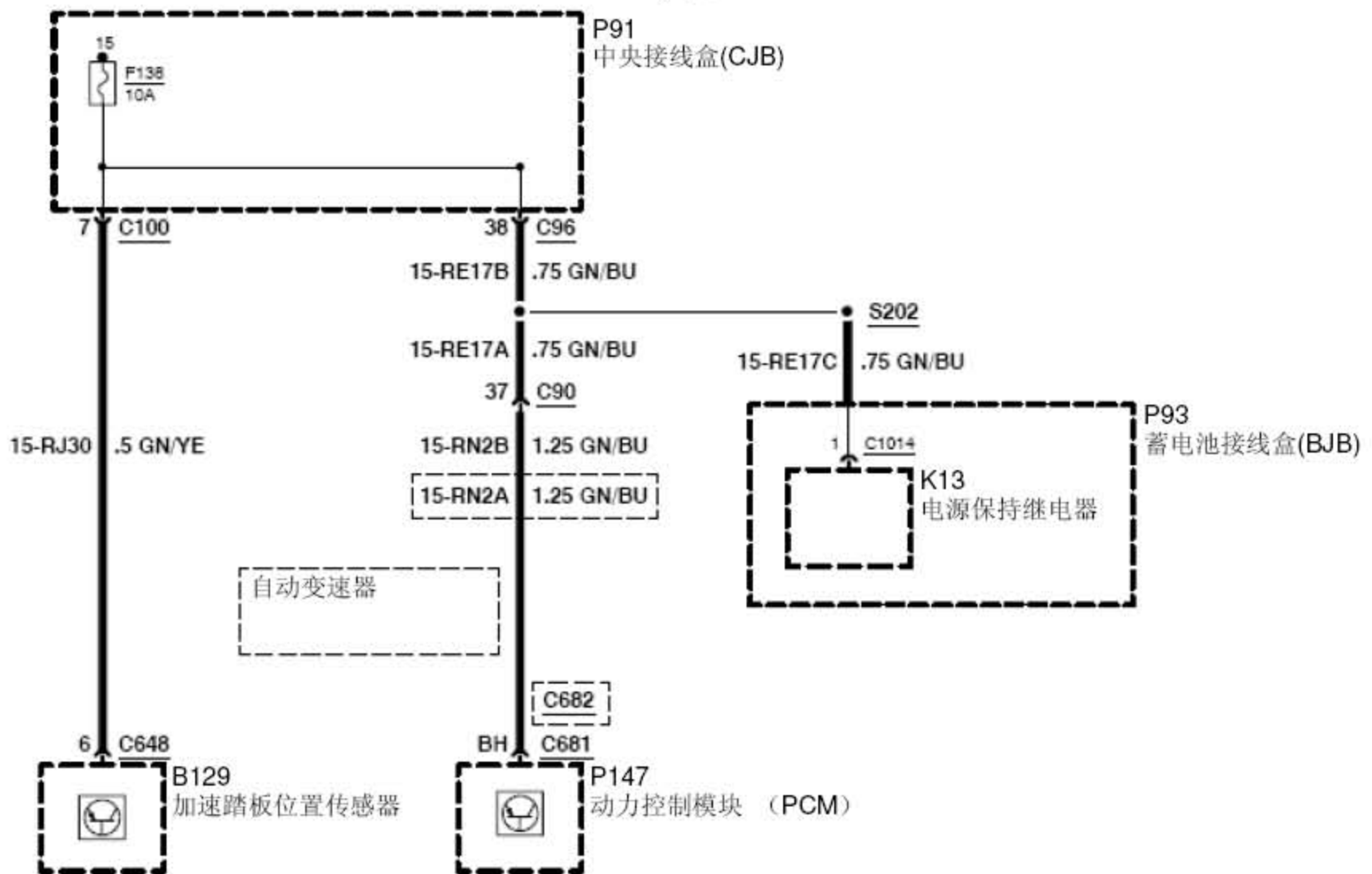

保险丝细节—F138, 1.8/2.0L Duratec-HE (MI4)

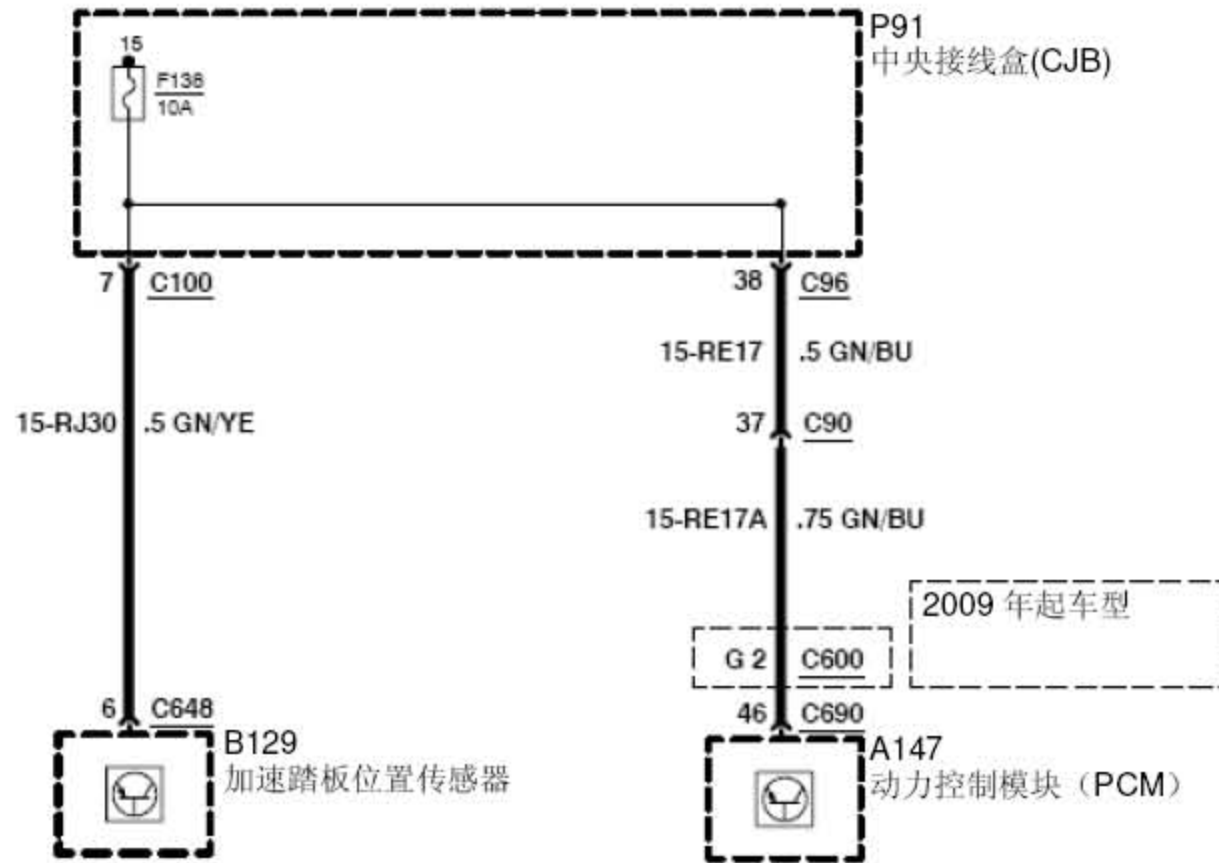

保险丝细节—F138, 2.0L Duratorq-TDCi (DW) 柴油

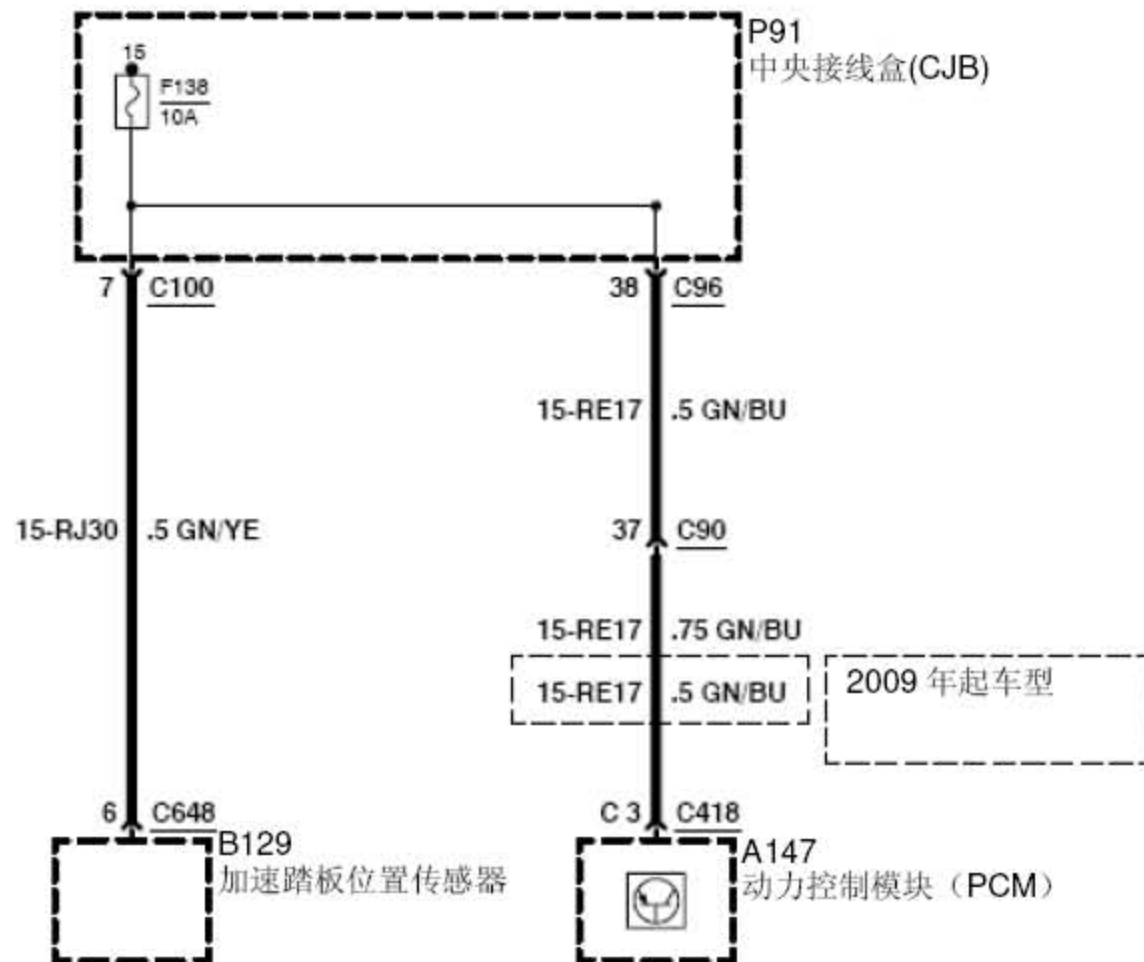

保险丝细节—F139, F140



保险丝细节—F141, 手动变速器

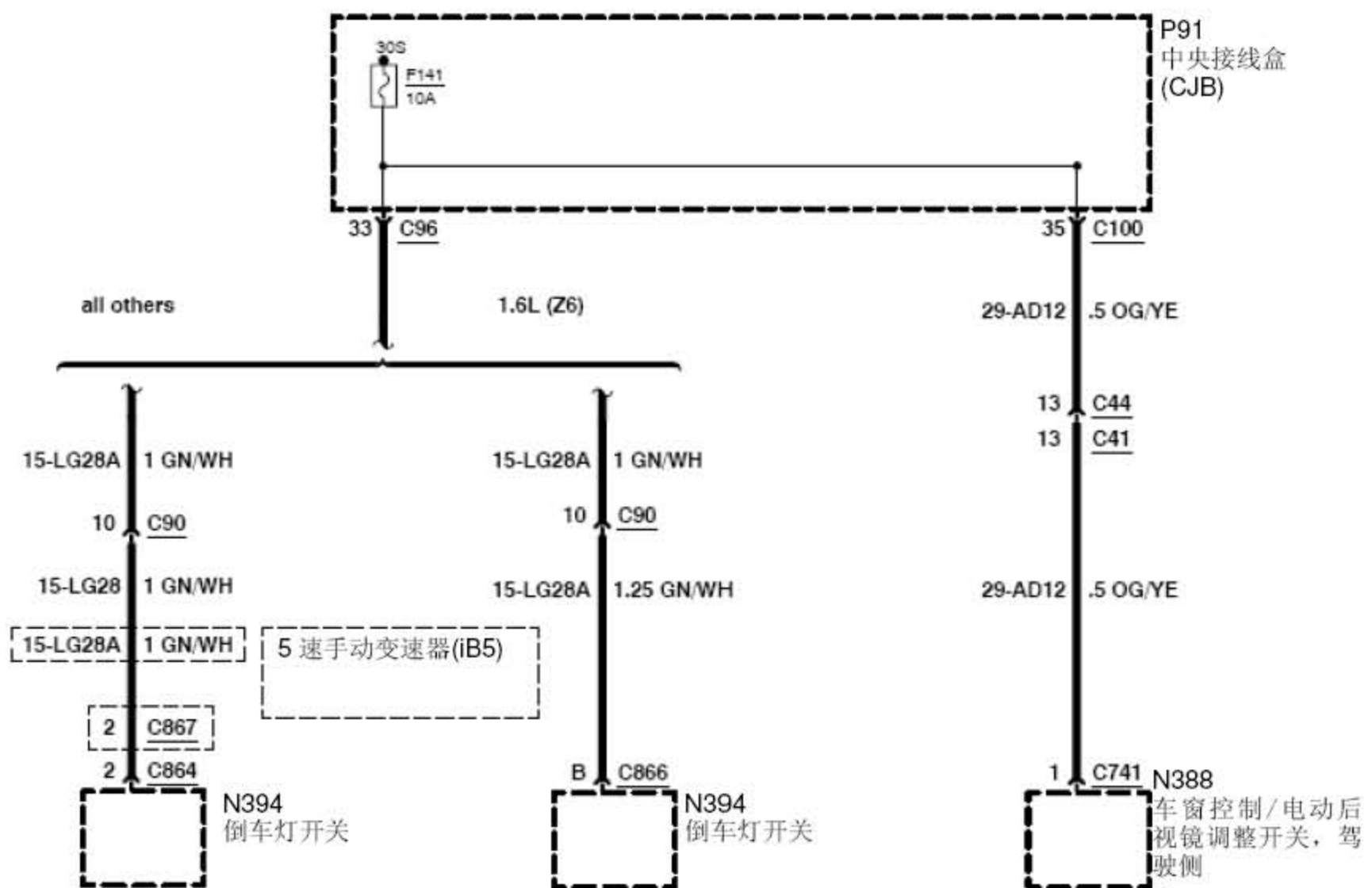

保险丝细节—F141, 自动变速器, 手动变速器 (MPS6)

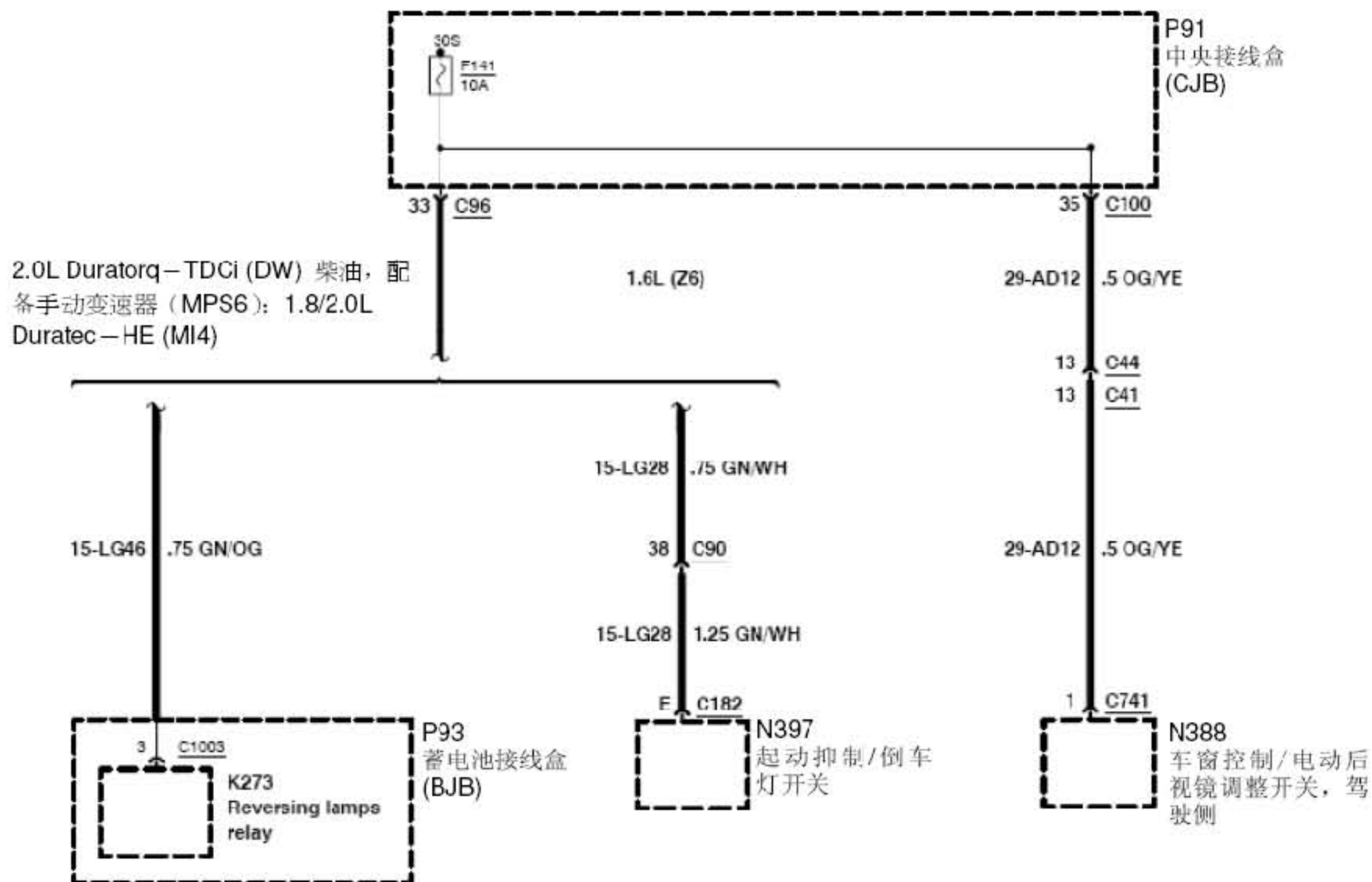

保险丝细节—F142, F143

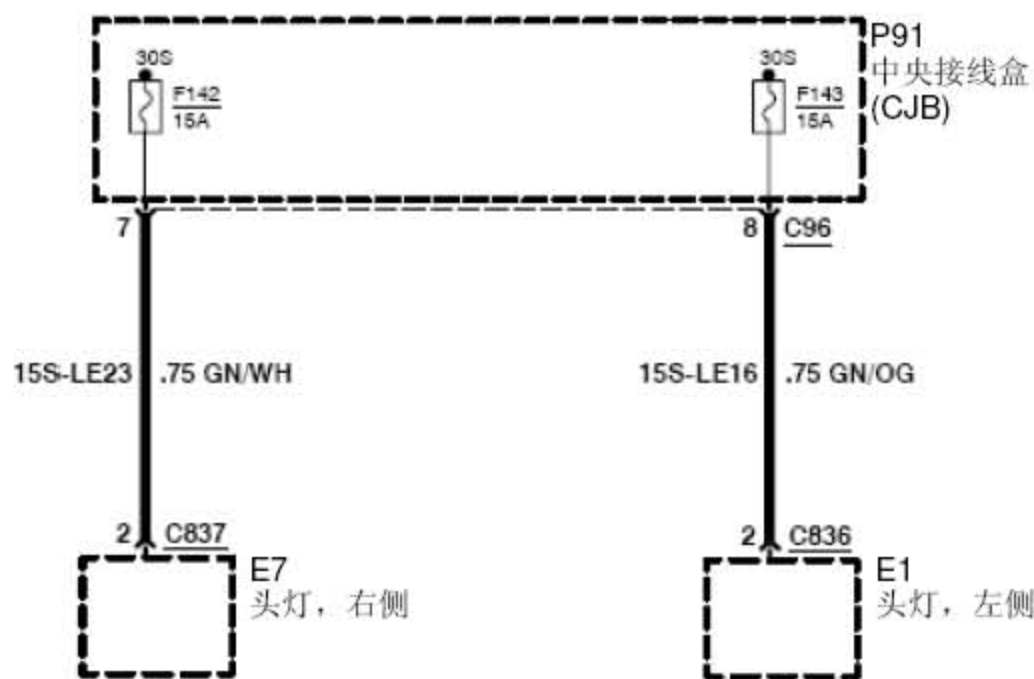

保险丝细节—F1000, except 1.6L (Z6)

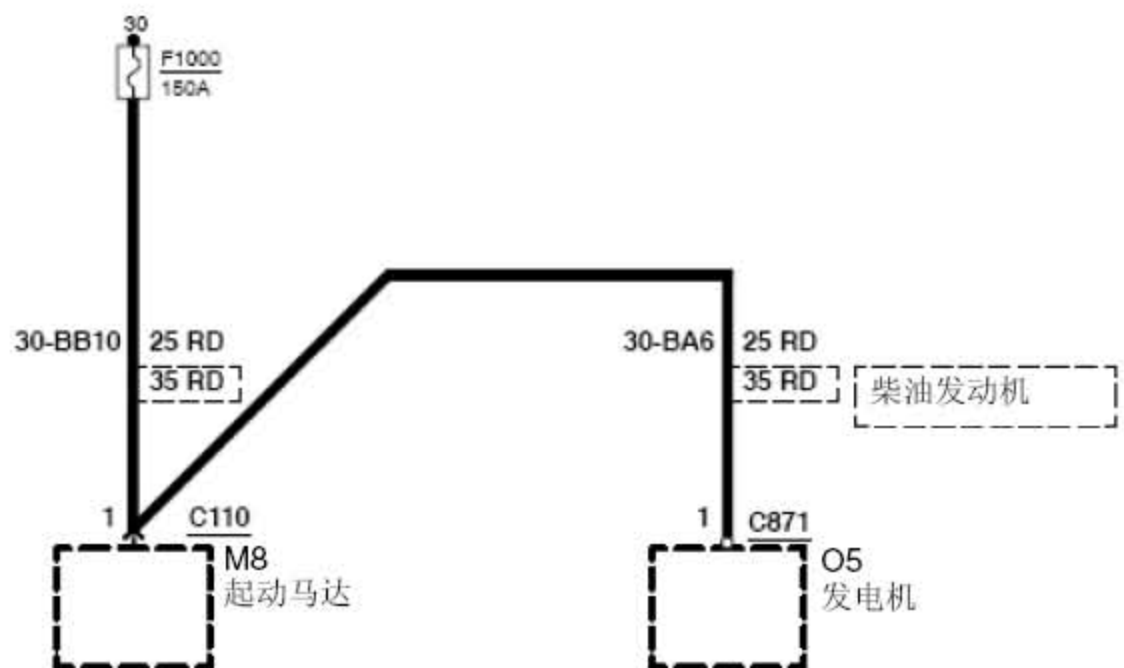

保险丝细节—F1000, 1.6L (Z6)

