

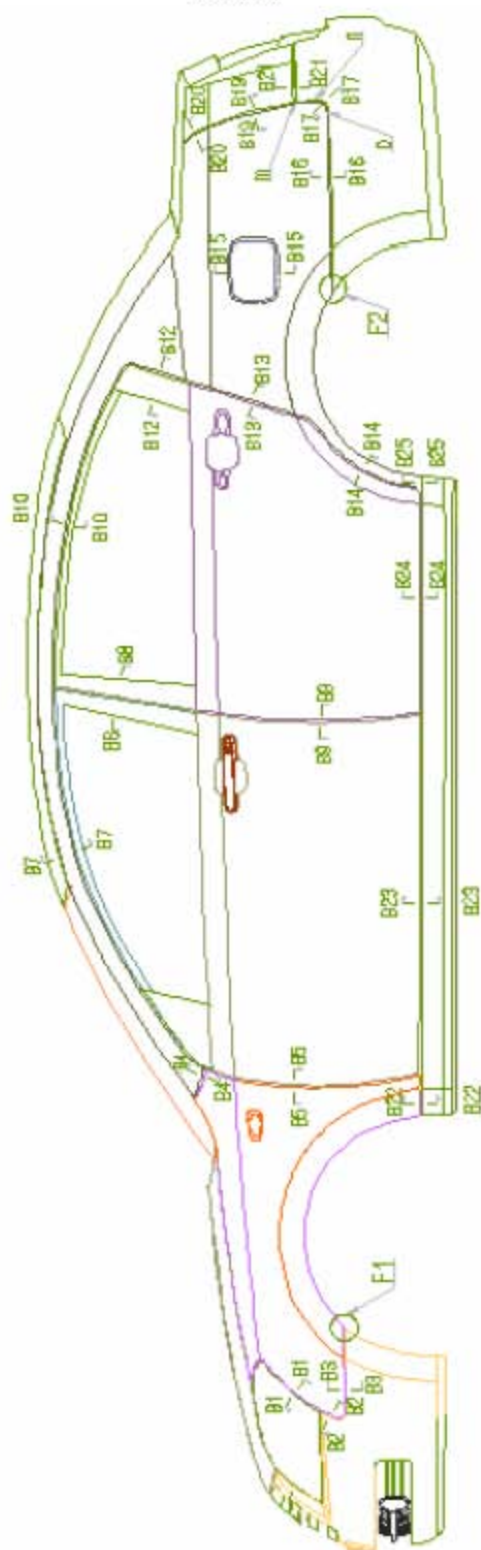

车身装配尺寸:

侧面图



B1-B1 处前翼子板与前大灯的间隙为： $1.5 \pm 1$

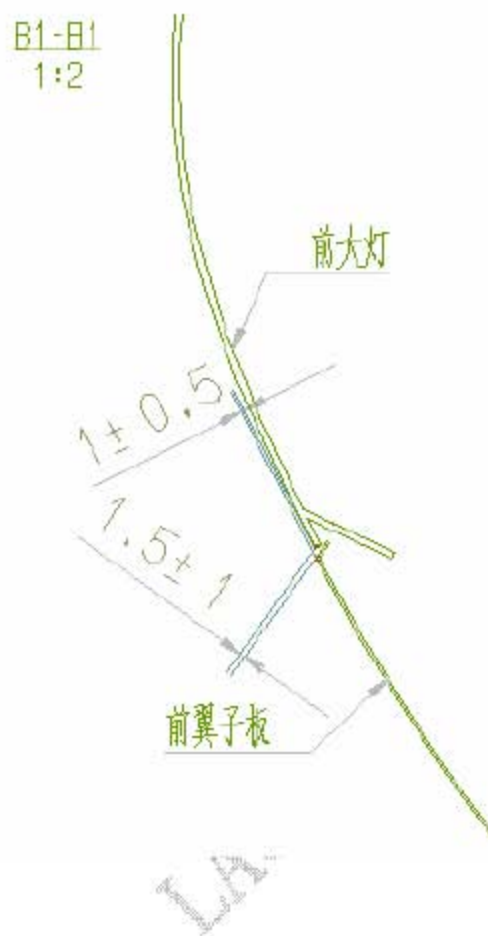

B2-B2 处前翼子板与前保险杠的间隙为： $0^{+0}_{-1}$

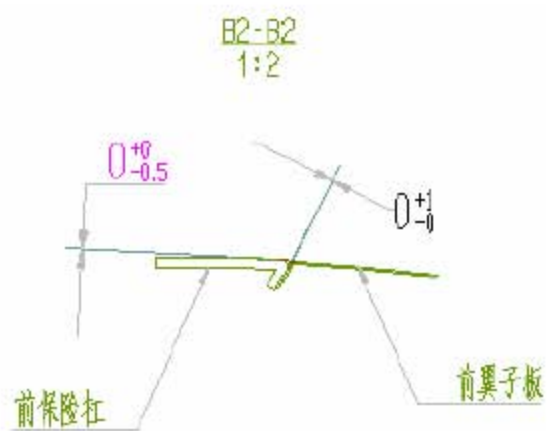

B3-B3 处前翼子板与前保险杠的间隙为： $0^{+0}_{-1}$

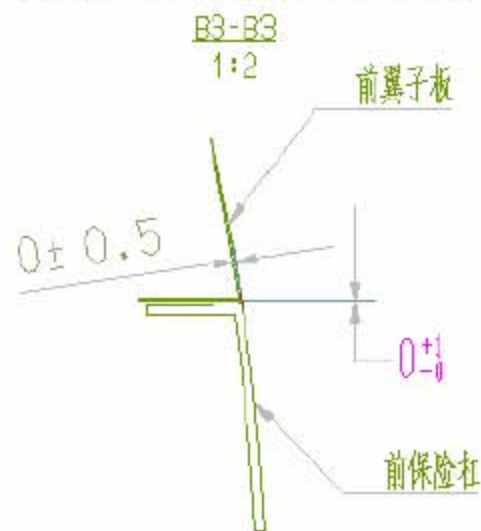

F1 处前翼子板与前保险杠的安装允许偏差为： $0^{+0}_{-1}$

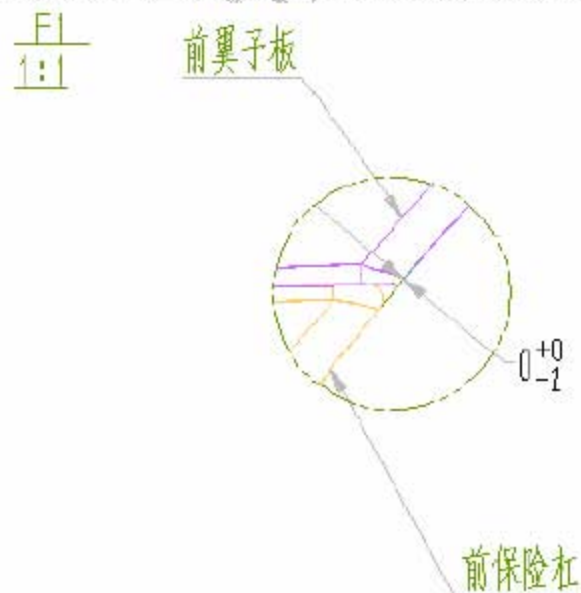

B4-B4 处前翼子板与侧围的间隙为:  $3.2 \pm 0.5$



B5-B5 处前翼子板与前门的间隙为:  $4.5 \pm 1$

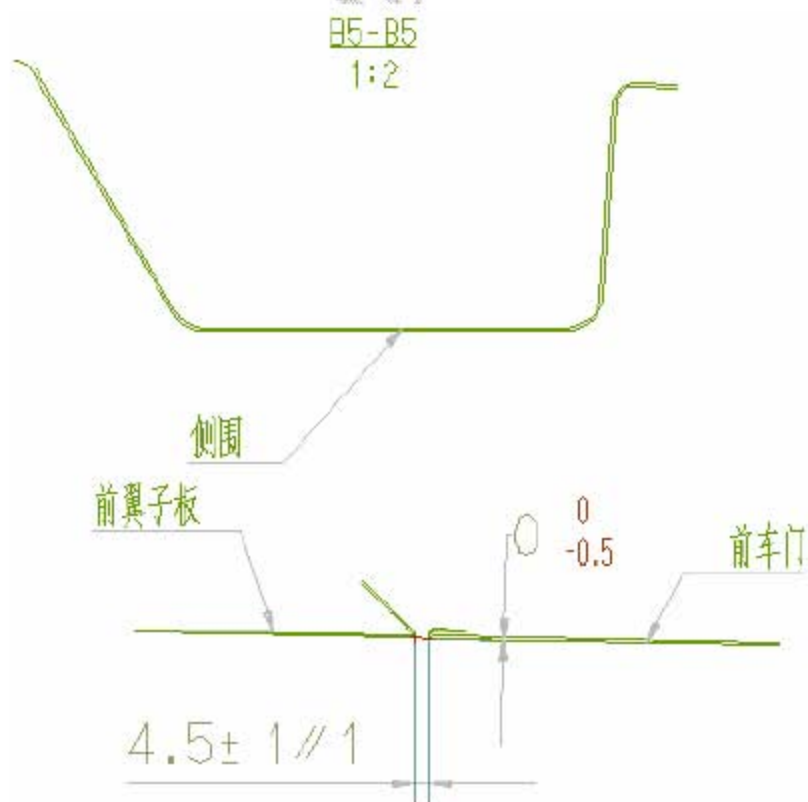

B7-B7 处侧围与前车窗窗框的间隙为:4.5

B7-B7  
1:2



B8-B8 处前车窗窗框与后车窗窗框的间隙为:4.5±1

B8-B8  
1:2

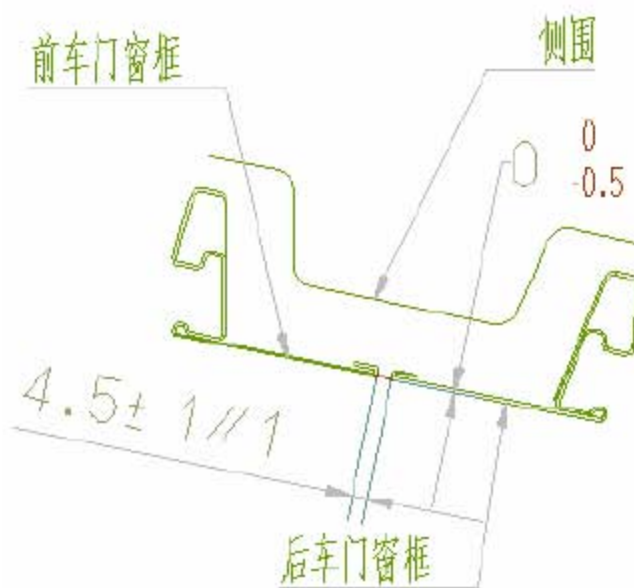

B9-B9 处前车门与后车门的间隙为 $4.5 \pm 1$

B9-B9  
1:2

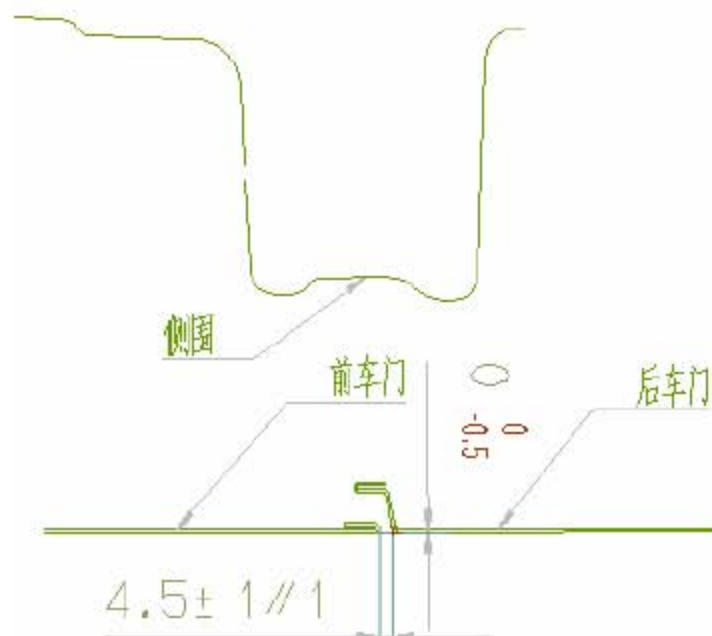

B10-B10 处后车门窗框与侧围的间隙为4.5

B10-B10  
1:2



B12-B12 处后车门后部装饰板与侧围的间隙为:4



B13-B13 处后车门与侧围的间隙为:4.5





B14-B14 处后车门与侧围的间隙为:  $4.5 \pm 1$



B15-B15 处加油口盖与侧围的间隙为:  $3 \pm 1$

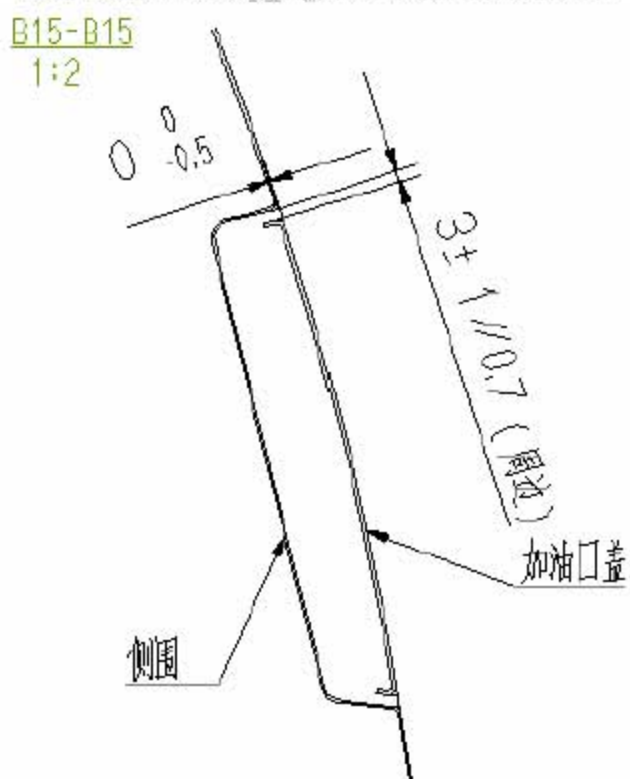

B16-B16 处后保险杠与侧围的间隙为:0±1

B16-B16

1:2

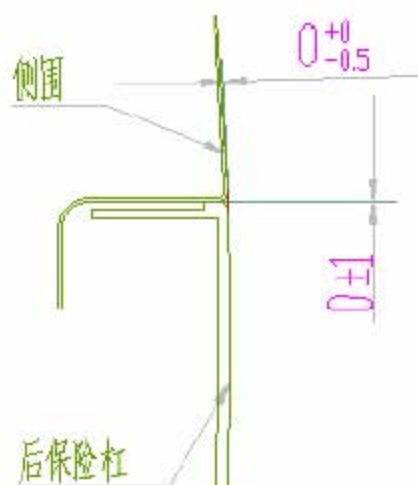

B17-B17 处后保险杠与侧围的间隙为:0±0.5

B17-B17

1:2

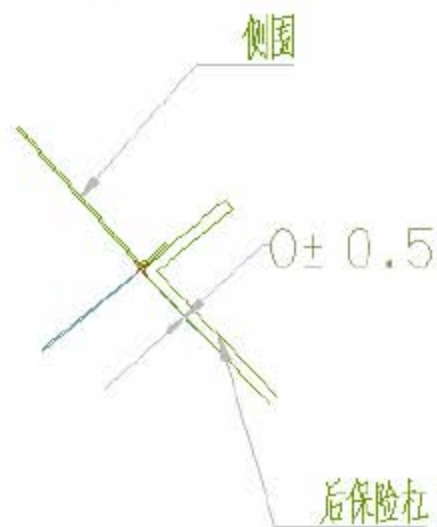

B19-B19 处侧围与尾灯的间隙为:  $1 \pm 0.5$



B20-B20 处侧围与尾灯的间隙为:  $1 \pm 0.5$

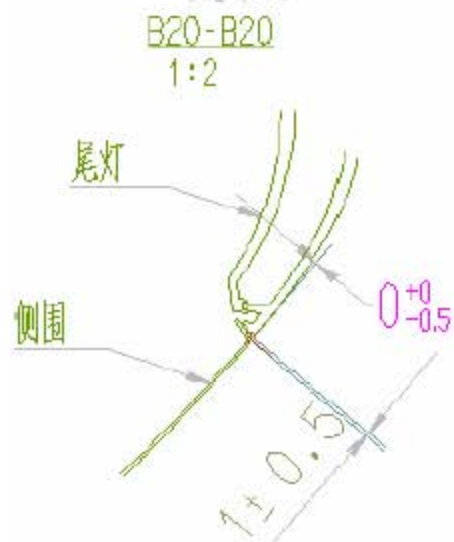

B21-B21 后保险杠与尾灯的间隙为:1.7



B22-B22 处前翼子板与侧裙护板的间隙为:  $2.5 \pm 1$

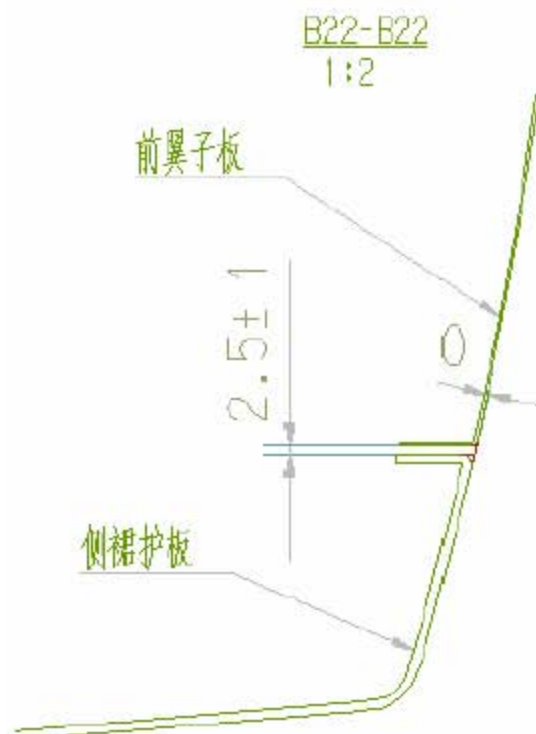

B23-B23 处前车门与侧裙护板的间隙为:  $6.3 \pm 1$



B24-B24 处后车门与侧裙护板的间隙为:  $6.4 \pm 1$



B25-B25 处侧裙护板与侧围的间隙为:  $3 \pm 1$

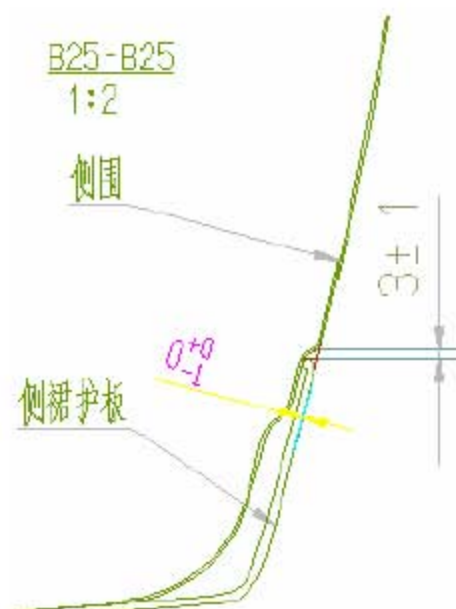

F2 处后保险杠与侧围(后翼子板部分)的安装允许偏差为:  $0+0 / -1$

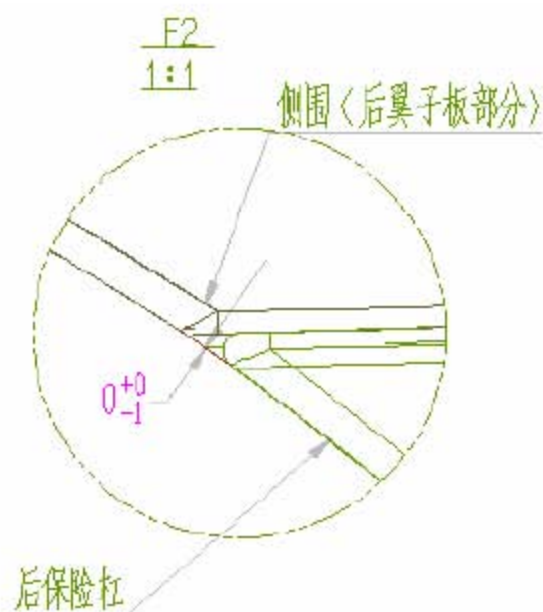

## 俯视图:

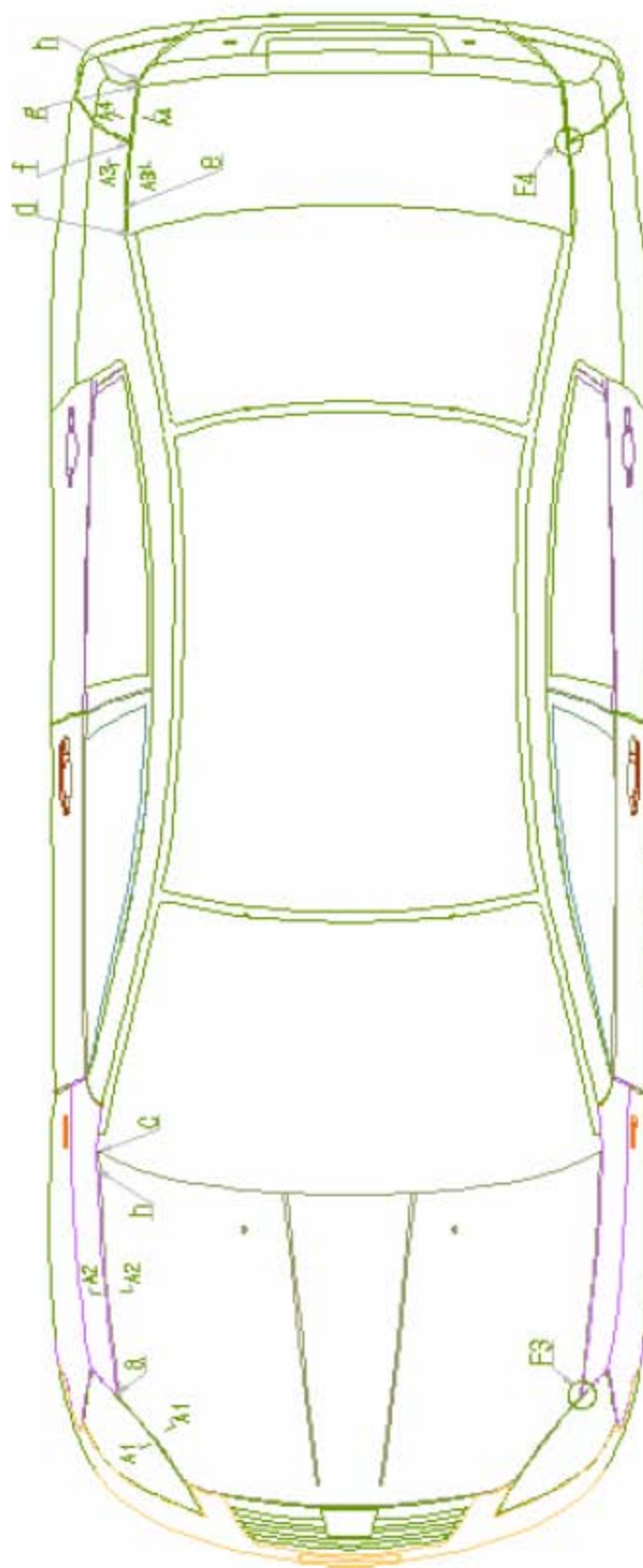

A1-A1 处前大灯与发动机盖的间隙为:  $3 \pm 1$

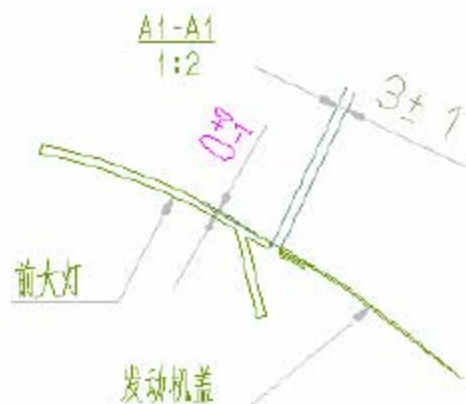

A2-A2 处前翼子板与发动机盖的间隙为:  $4 \pm 1$





A3-A3 处行李箱盖与侧围(后翼子板部分)的间隙为:  $4 \pm 1$

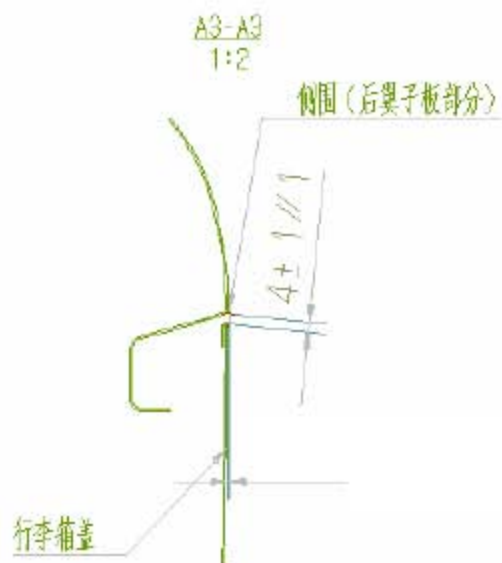

A4-A4 处尾灯与行李箱盖的间隙为:  $4 \pm 1$

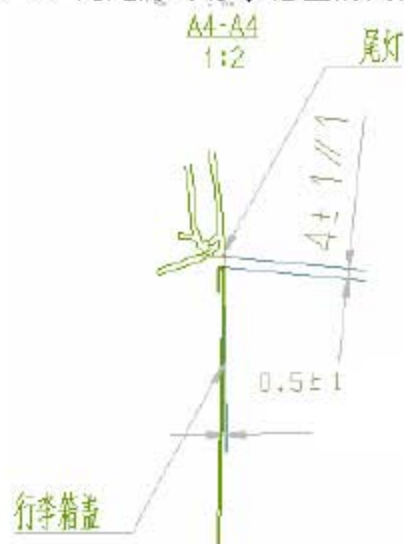

F3 处前大灯与发动机盖的间隙为： $0^{+0}_{-0.5}$

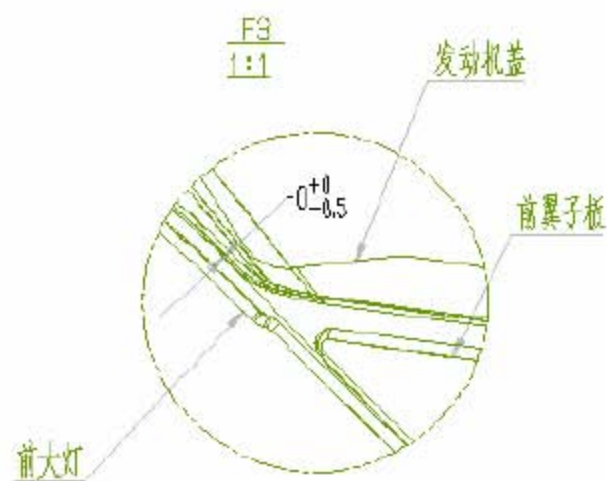

F4 处尾灯与行李箱盖的间隙为： $0^{+0}_{-0.5}$

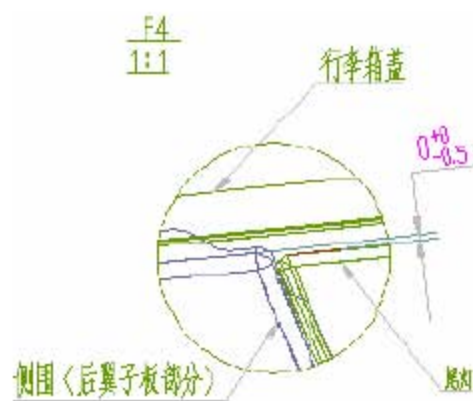

## 后视图:

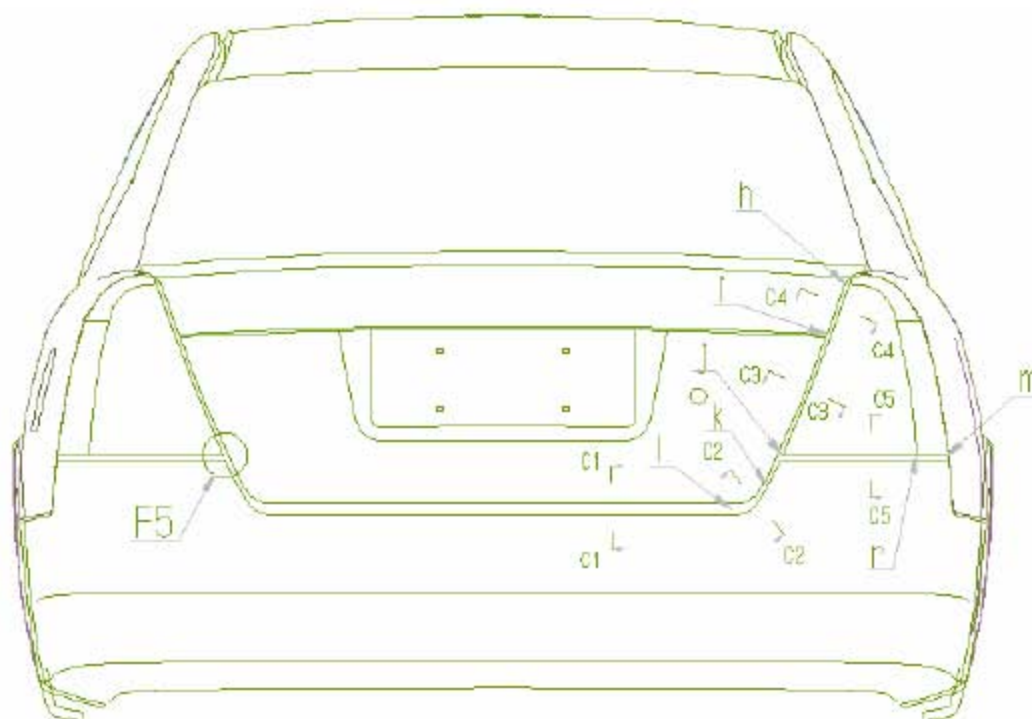

C1-C1 处后保险杠与行李箱盖的间隙为:8.2

$\frac{C1-C1}{1:2}$



C2-C2 处后保险杠与行李箱盖的间隙为:4



C3-C3 处尾灯与行李箱盖的间隙为:4±1

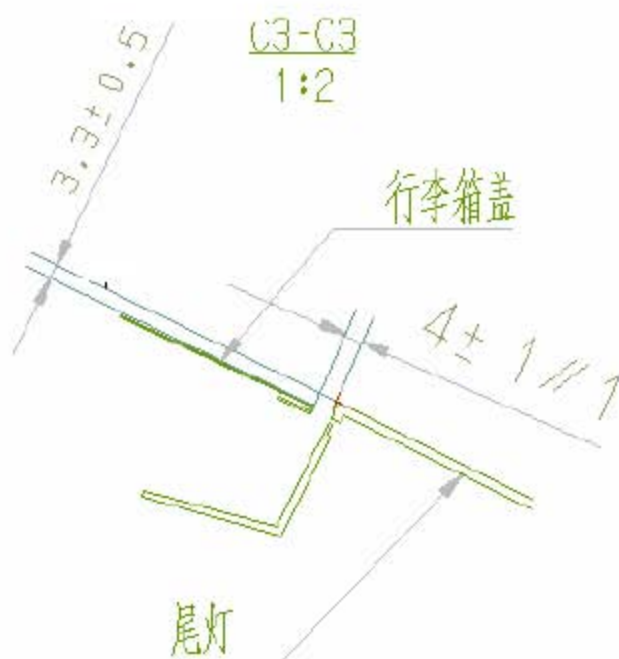

C4-C4 处尾灯与行李箱盖的间隙为:  $4 \pm 1$

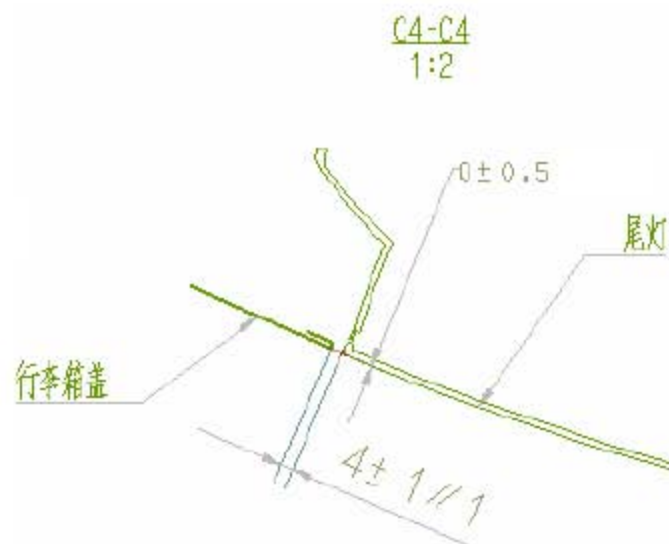

C5-C5 处后保险杠与尾灯的间隙为:  $3 \pm 1$

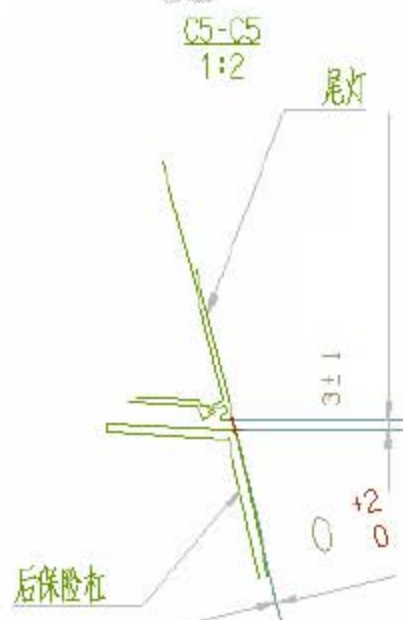

F5 处后保险杠与行李箱盖的安装允许偏差为： $0^{+0.5}_{-0.5}$

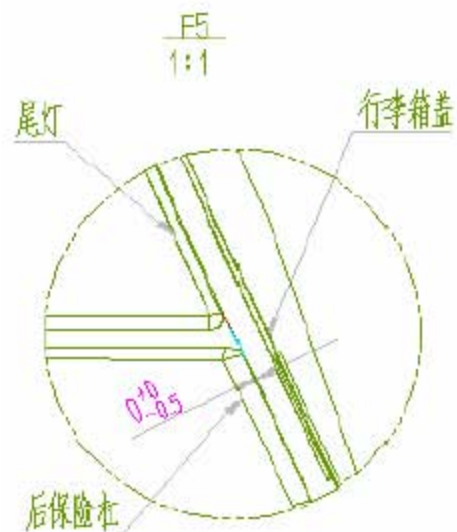

前视图:

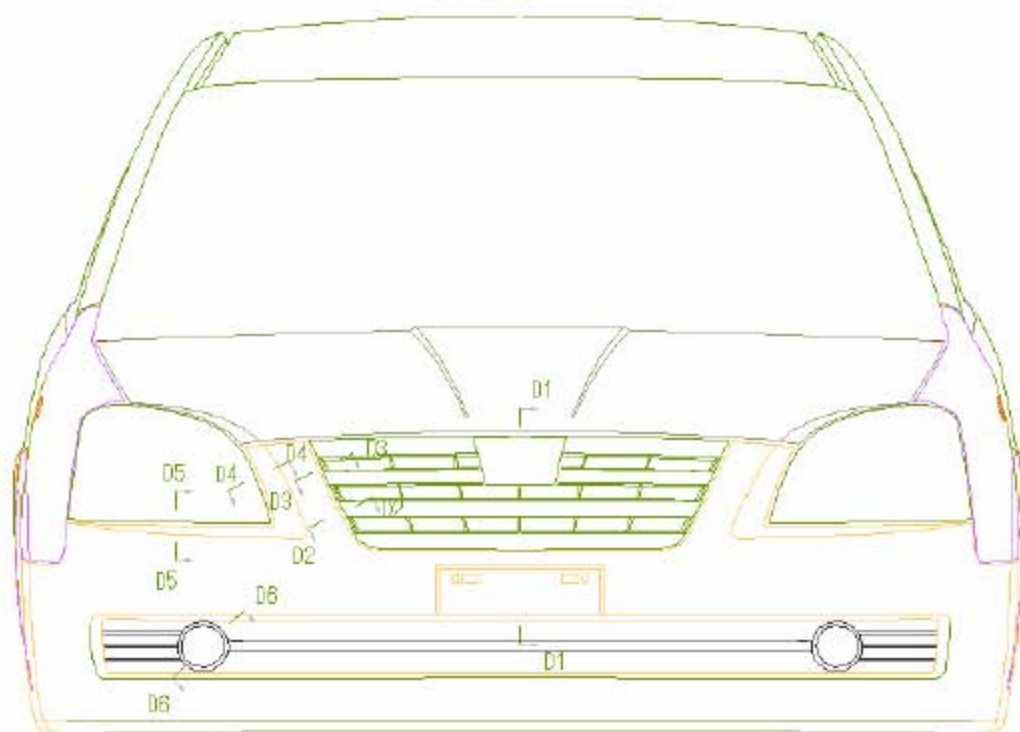

D1-D1 处发动机盖与进气格栅的间隙为  $4.5 \pm 1$ , 前保险杠与进气格栅的间隙为:  $1 \pm 0.5$

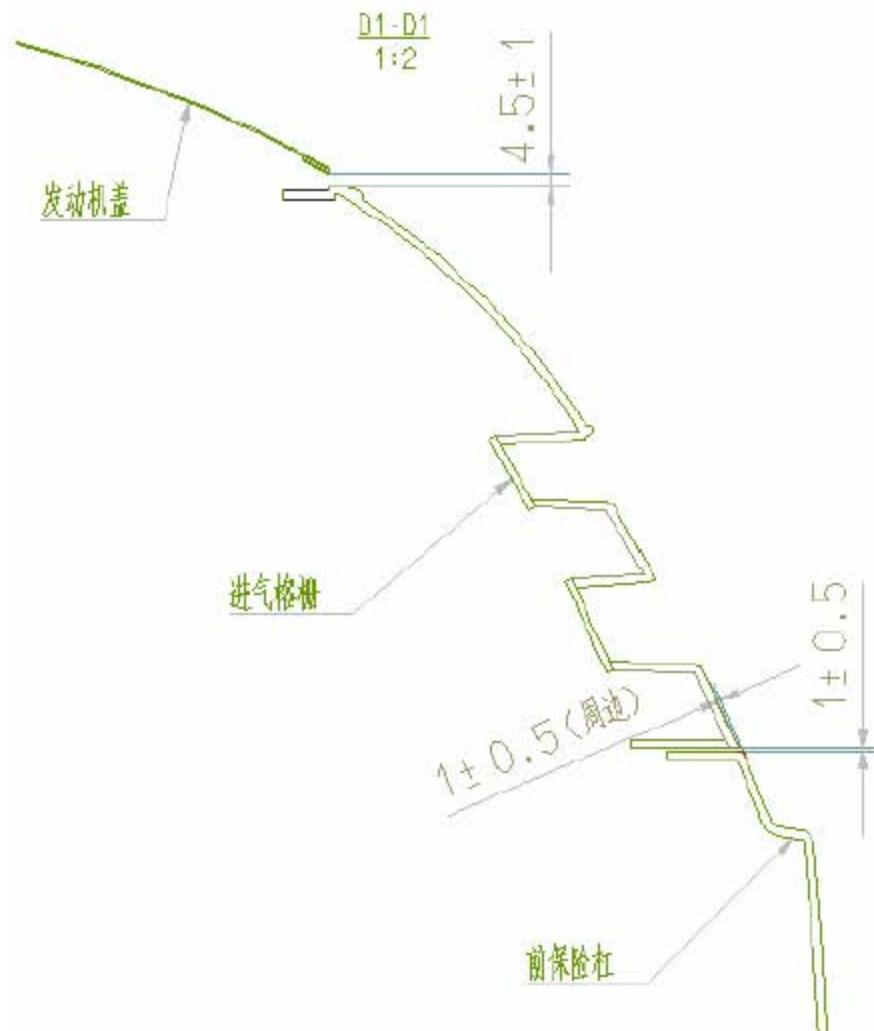

D2-D2 处前保险杠与进气格栅的间隙为:  $1.5 \pm 1$

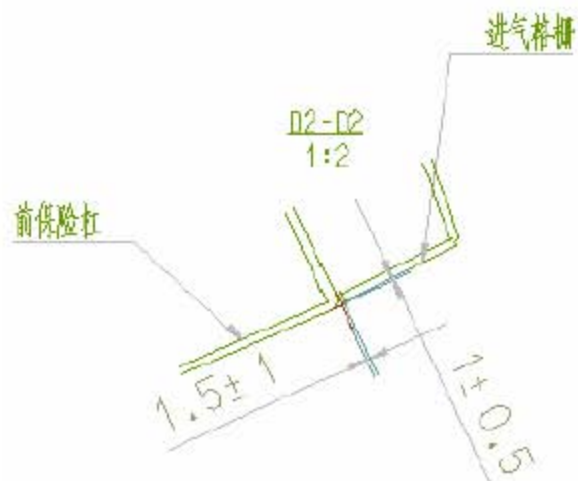

D3-D3 处前保险杠与进气格栅的间隙为:  $1.5 \pm 0.5$

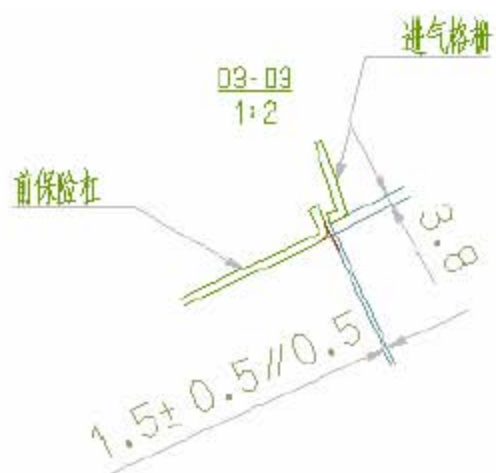

D4-D4 处前大灯与前保险杠的间隙为  $4 \pm 1$

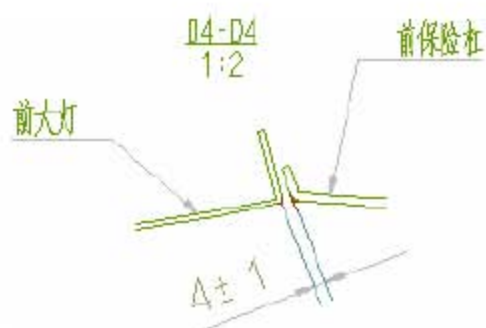

D5-D5 处前大灯与前保险杠的间隙为:  $4 \pm 1$

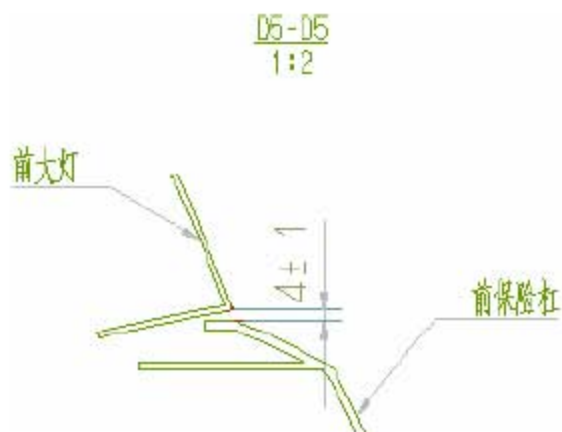



D6-D6 处前雾灯与前保险杠的间隙为： $0^{+0.5}$

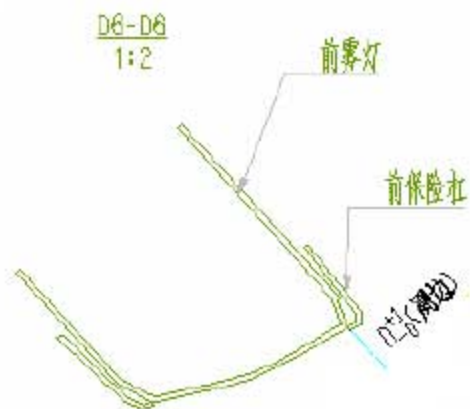

机舱尺寸表：

符号	名称	孔径	符号	名称	孔径
A	水槽本体安装孔	7	F	发动机右悬置支座用孔	11
Bb	翼子板安装用孔	7	g	前大灯用孔	7
Cc	减震器用过孔	115	h	前大灯用孔	7
Dd	翼子板安装用孔	7	i	灯安装用孔	7
e	电瓶支座安装用孔	9	J	保险杠用孔	9
E	发动机右悬置支座用孔	11	K	冷凝器用孔	8X12

## 风窗尺寸:

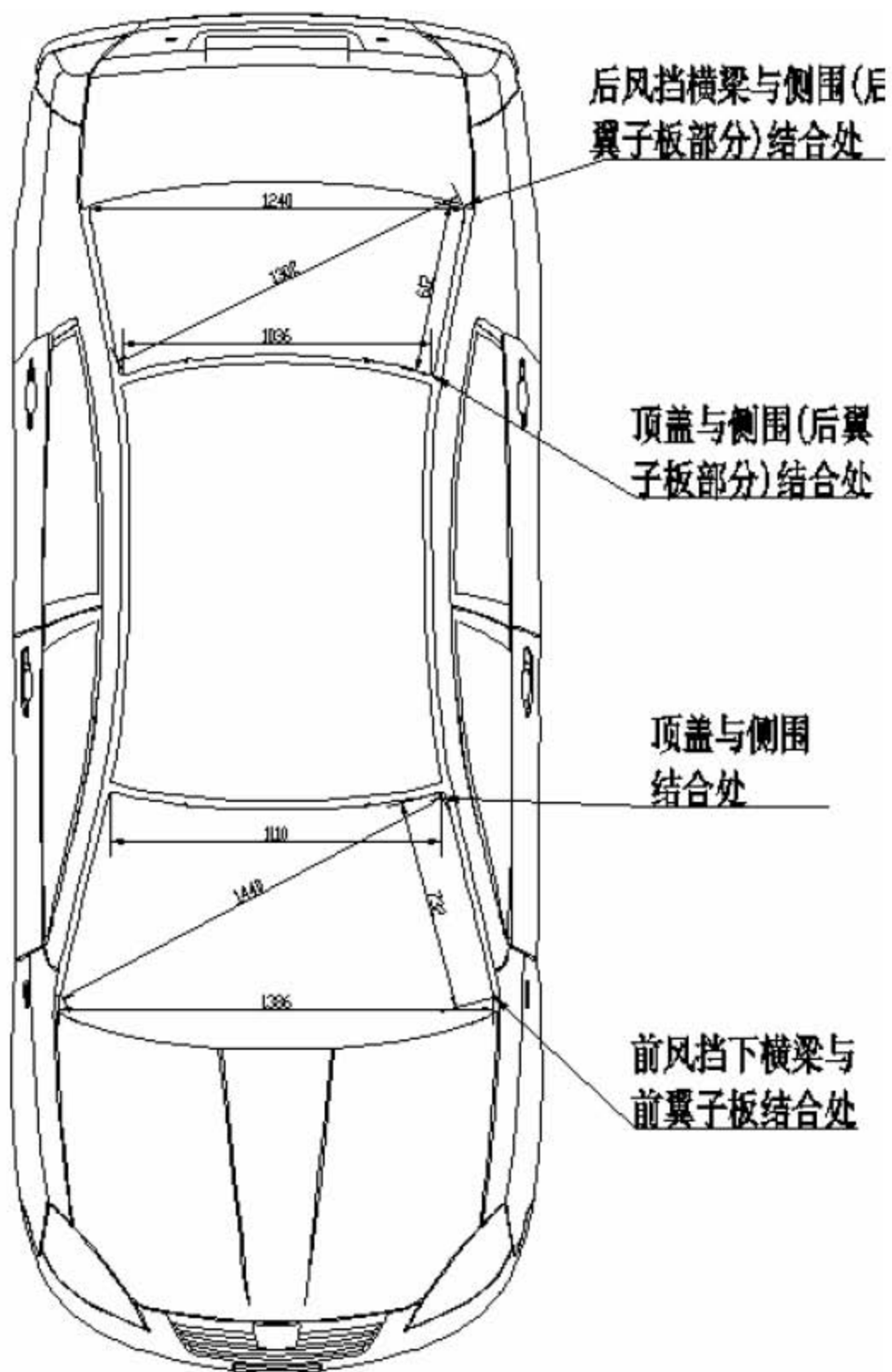

## 各部分开口尺寸:

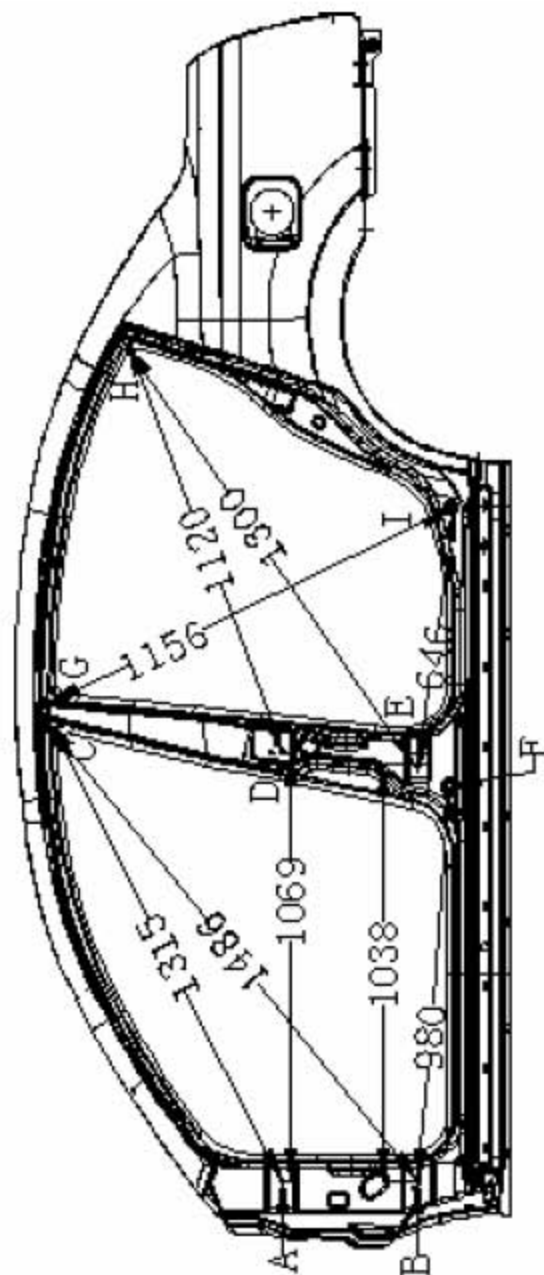

车身尺寸:左—右

**备注:** 英文字母符号的大写字母表示车身左侧, 小写字母表示车身右侧 (从汽车后部看)。

符号	名称	孔径	符号	名称	孔径
Aa	前门上铰链安装孔	11	Ff	前门支撑点	
Bb	前门下铰链安装孔	11	Gg	侧围后门导轨前上角点	
Cc	侧围前门导轨上角点		Hh	侧围后门导轨后上角点	
Dd	后门上铰链安装孔	11	Ii	后门支撑点	
Ee	后门下铰链安装孔	11			

LAUNCH