

3.7 发动机控制零部件位置

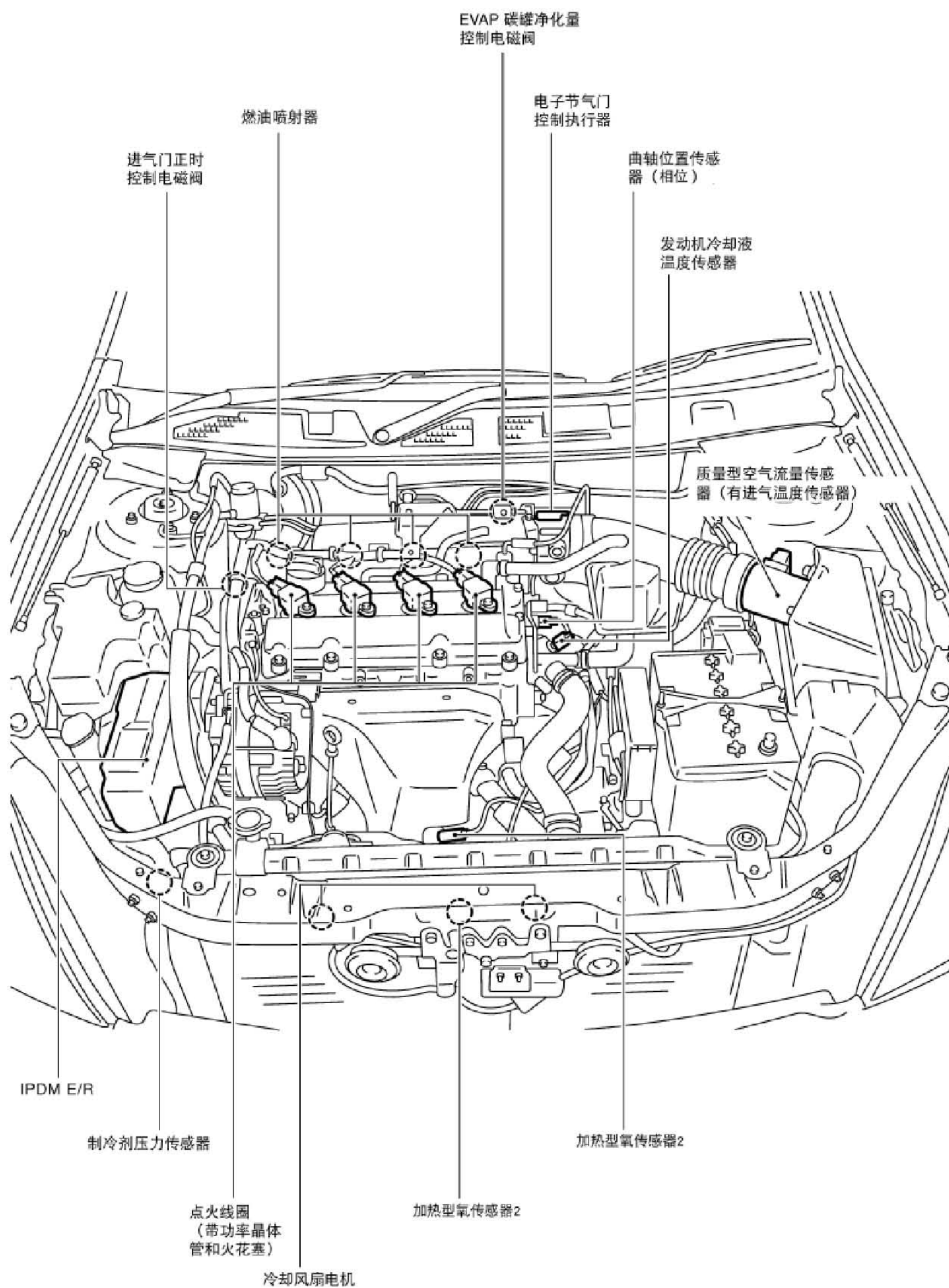

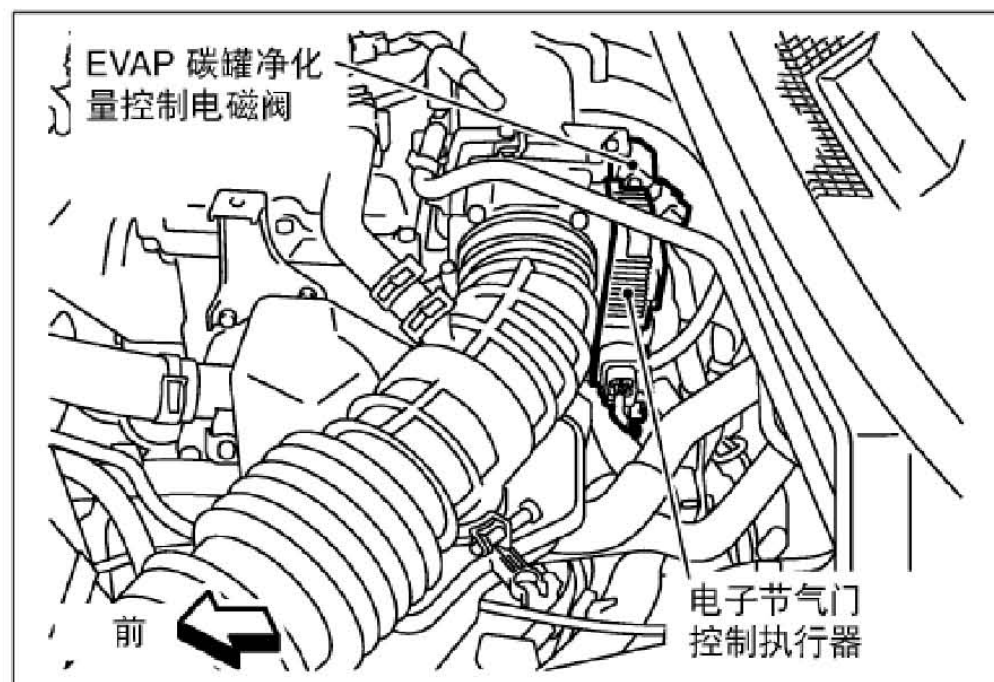

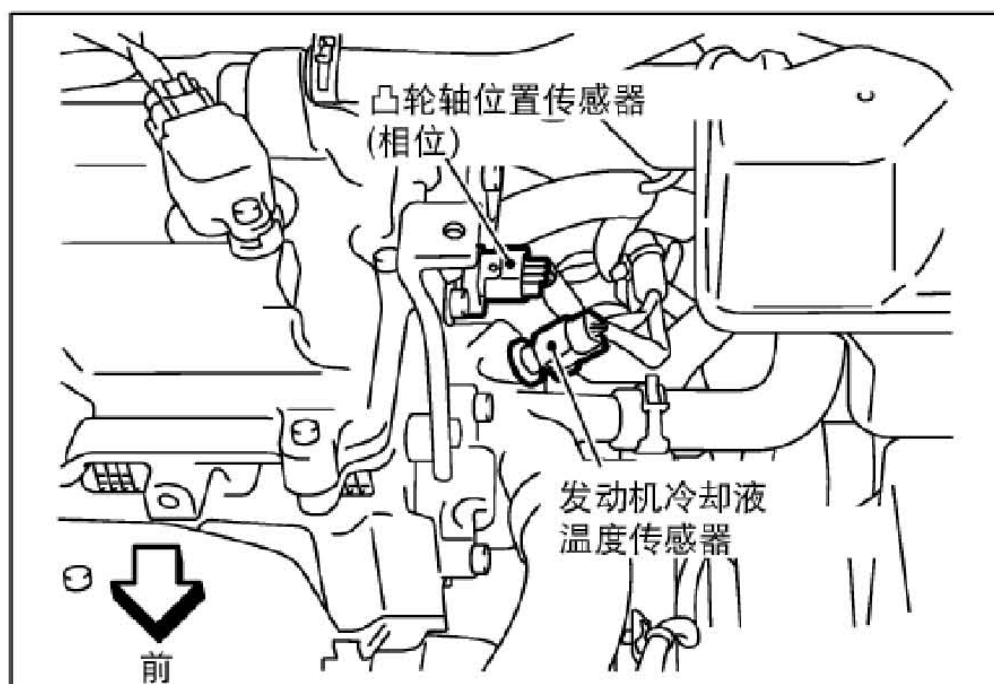

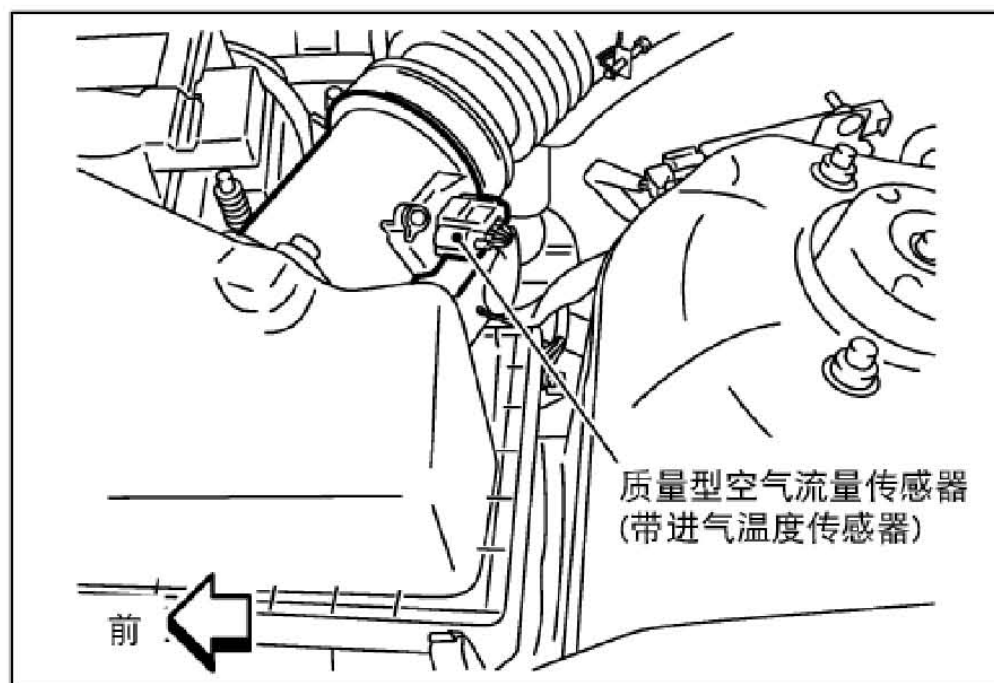
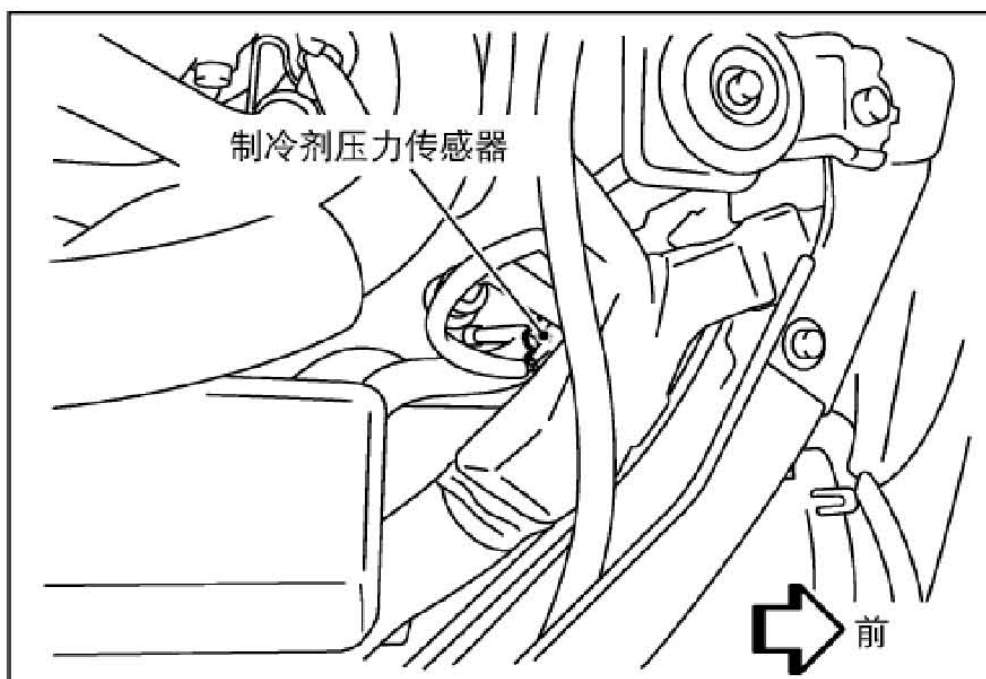
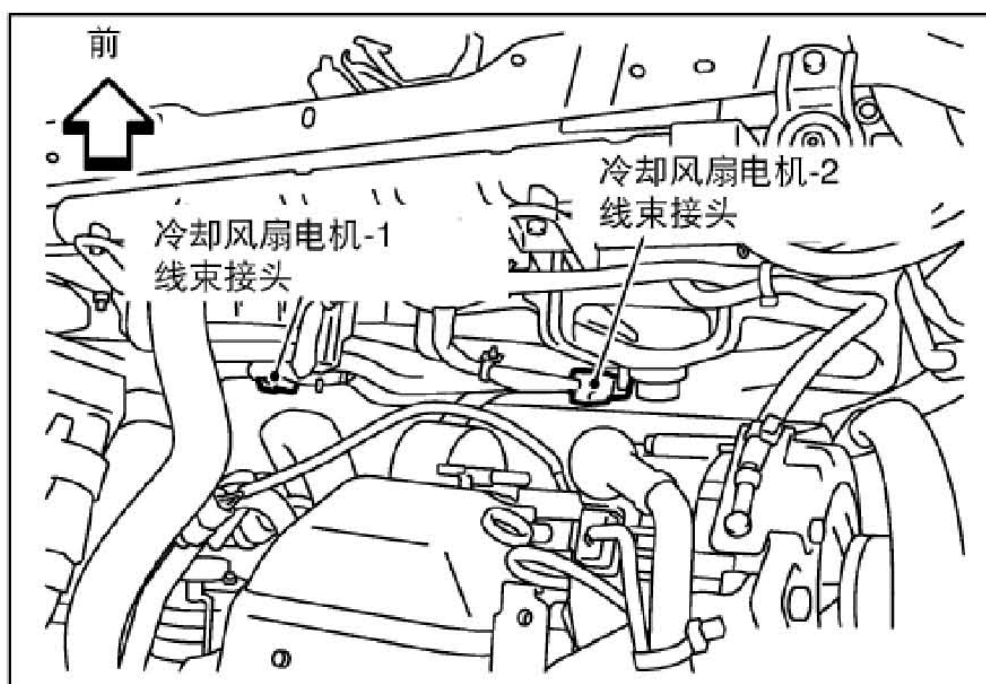
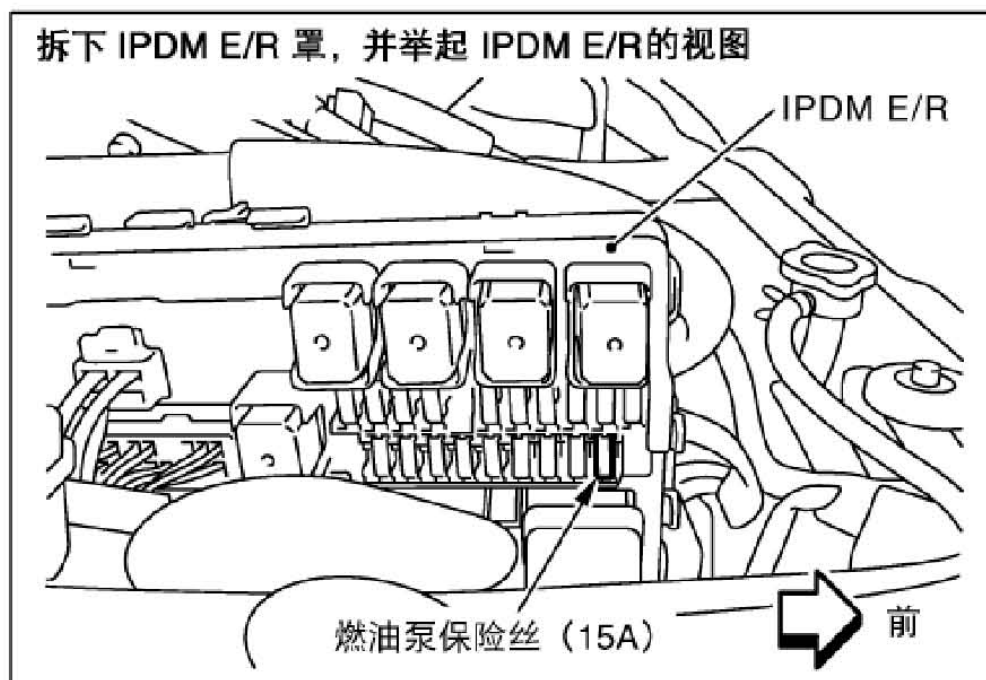
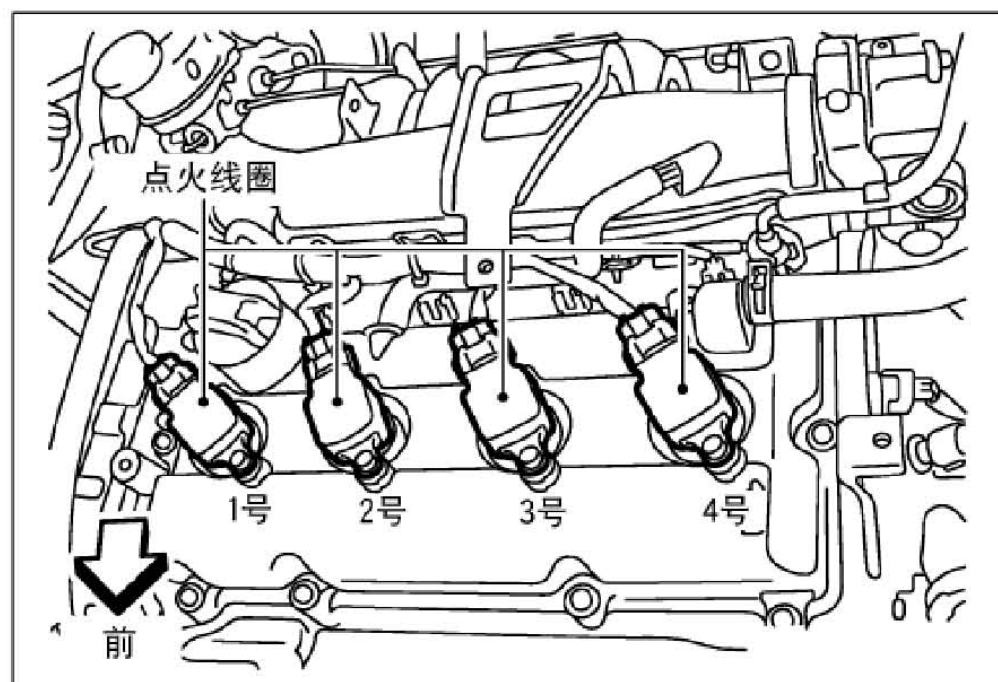
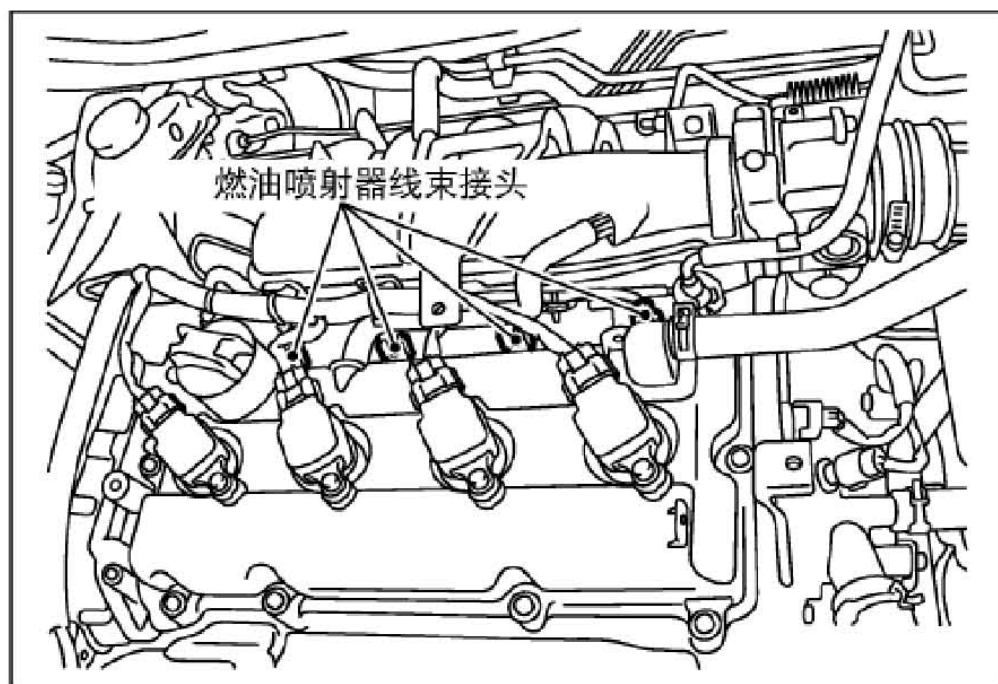
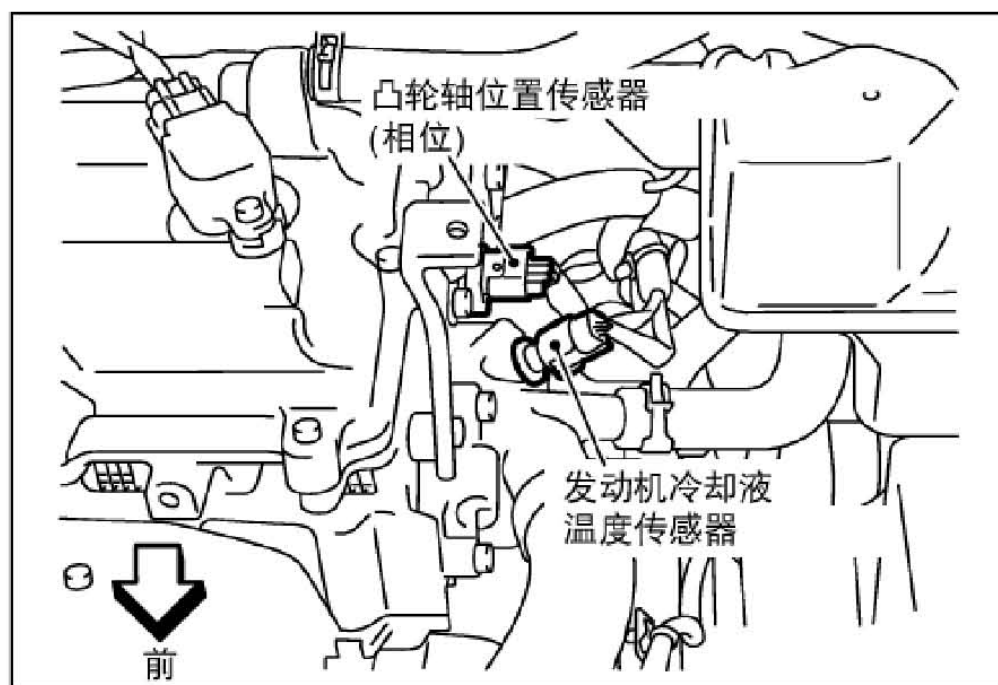

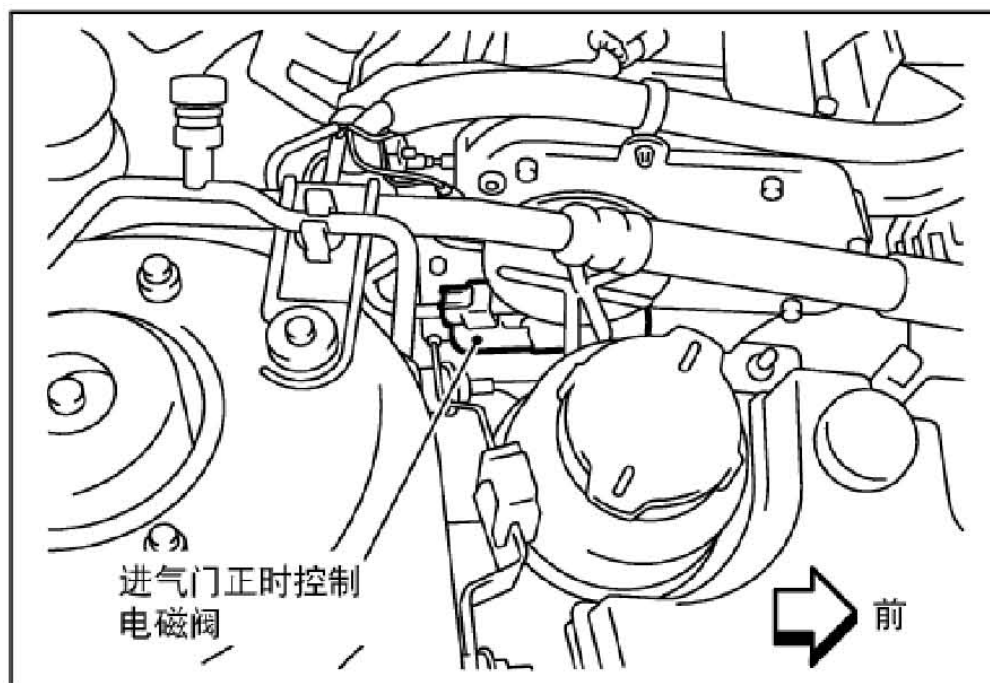

进气歧管总管和摇臂盖之间的视图

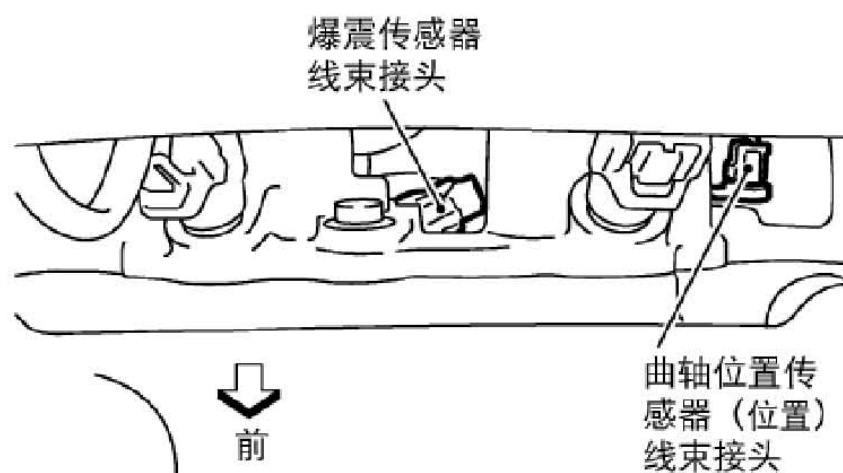

拆下发动机后的视图



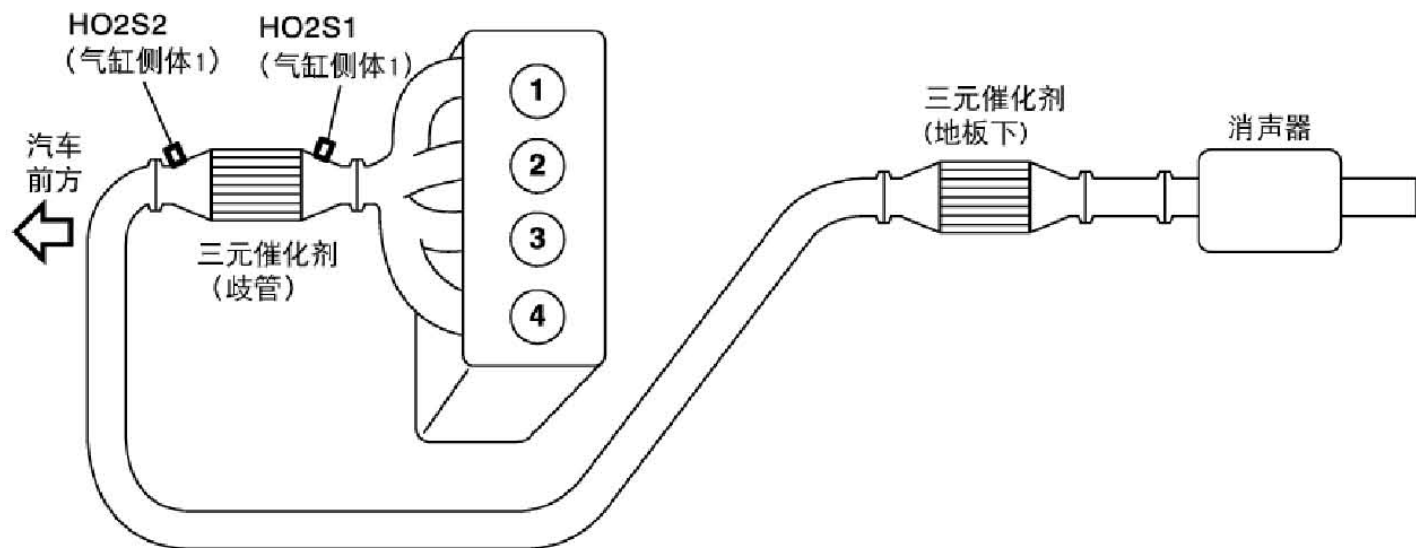
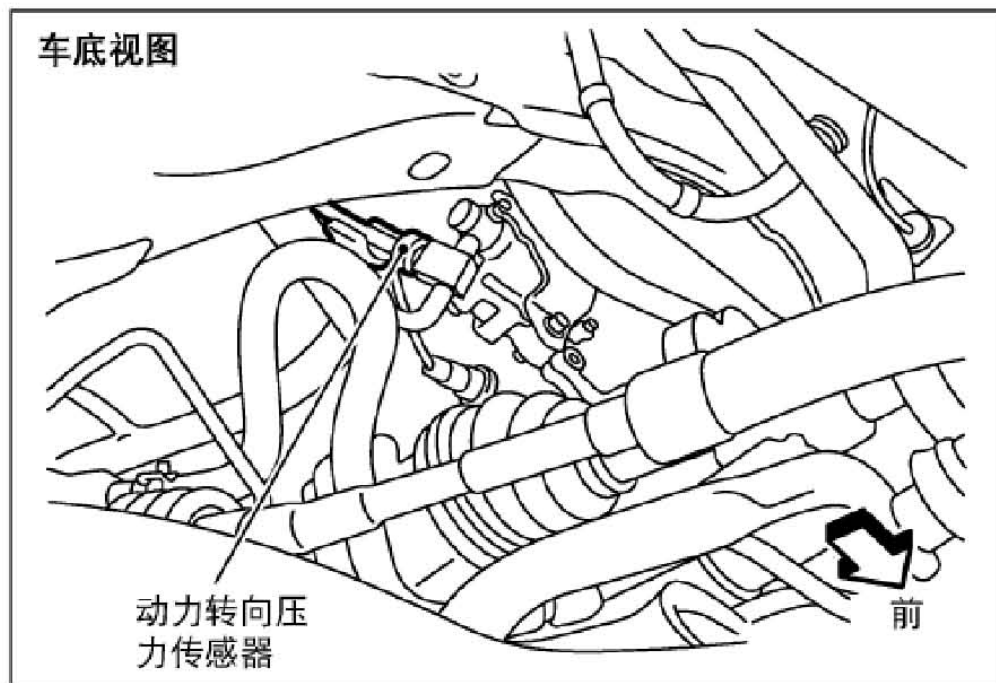

气缸侧体

共用一个相同控制传感器的具体气缸组，气缸侧体1总是包含气缸1，而气缸侧体2是相对的一侧。

传感器编号

传感器相对于发动机气流的位置，从新鲜空气进口开始，直至汽车排气管，顺序编号为1、2、3等等

